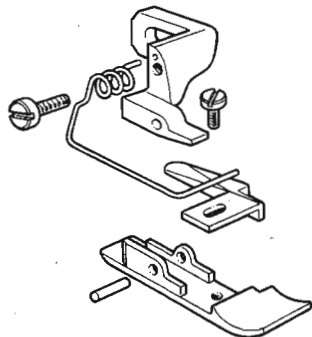

PIEDINO  
PRESSER FOOT  
PIED-PRESSEUR  
DRUECKERFUSS

**Rimoldi****PIEDINO****PRESSER FOOT****PIED PRESSEUR****DRUECKERFUSS**

Indice				TAB	<b>R300</b>
Data				Foglio 1	Segue F. 2

**200767-3-10**

Serve per  
Serves for  
Pour machines  
Dient fuer

023-04-01  
023-04-03  
023-04-04

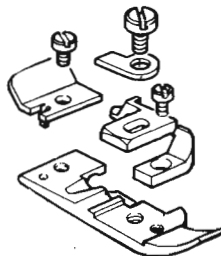
**202171-3-10**

Serve per  
Serves for  
Pour machines  
Dient fuer

327-00-1CD-01  
327-00-1CD-07  
028-00-03  
228-00-01  
228-00-05

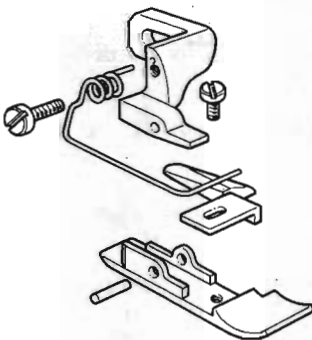
**200791-3-10**

Serve per  
Serves for  
Pour machines  
Dient fuer

023-04-02  
023-04-05

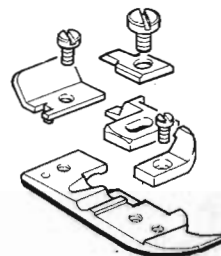
**202172-3-10**

Serve per  
Serves for  
Pour machines  
Dient fuer

327-00-1CD-01  
327-00-1CD-07  
327-01-1CD-01

Si rende noto che il contenuto della presente tavola  
non è da considerarsi un'opera di ingegneria, ma  
meramente divulgativa a terzi o viziata, sia integral-  
mente che parzialmente senza l'autorizzazione scritta  
della stessa azienda, tutelata i suoi diritti e l'immagine di legge.

Indice  
Data  
Vr.

modifiche



Si rende noto che il contenuto della presente tavola non potrà essere utilizzato o riprodotto, in tutto o in parte, senza permesso scritto dalla R. Arnoldi & C. S.p.A. in quanto il presente materiale è protetto da diritti di proprietà intellettuale che parzialmente sono riservati. R. Arnoldi & C. S.p.A. stessa intende tutelare i suoi diritti e norme di legge.

Indice									
Data									
Vr.									



**202178-3-10**

Serve per  
Serves for  
Pour machines  
Dient fuer

327-01-1CD-02  
327-01-1CD-04  
327-01-1CD-05  
028-01-02  
028-01-04  
228-01-01  
228-01-03  
228-01-04

**202509-3-10**

Serve per  
Serves for  
Pour machines  
Dient fuer

327-00-1CD-01  
327-00-1CD-07  
327-01-1CD-01  
028-00-01  
028-00-03  
028-01-01  
228-00-01  
228-00-05

**202182-3-10**

Serve per  
Serves for  
Pour machines  
Dient fuer

327-29-1CD-03  
028-29-03

**202641-3-10**

Serve per  
Serves for  
Pour machines  
Dient fuer

327-28-1CD-11  
028-00-08  
228-00-08



**Rumoldi**

PIEDINO

PRESSER FOOT

PIED PRESSEUR

DRUECKERFUSS

Indice				TAB	<b>R300</b>
Data				Foglio 5	Segue F. 6

202646-3-10

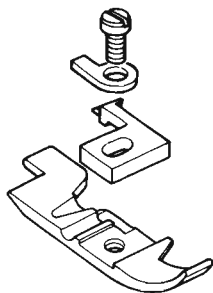

Serve per  
Serves for  
Pour machines  
Dient fuer

327-00-1CD-03  
028-00-05  
228-00-03

202732-3-00

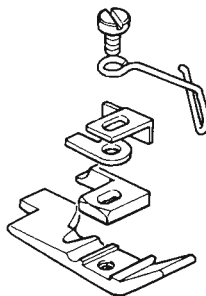

Serve per  
Serves for  
Pour machines  
Dient fuer

327-00-1CD-02  
228-00-14

202710-3-10

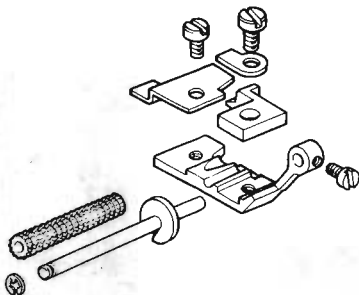

Serve per  
Serves for  
Pour machines  
Dient fuer

028-30-01

202752-3-10

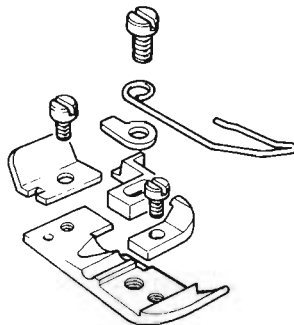

Serve per  
Serves for  
Pour machines  
Dient fuer

028-10-01

Si rende noto che il contenuto della presente tavola non deve essere utilizzato o riprodotto in tutto o in parte senza permesso scritto dalla proprietaria S.p.A. V. L. Rumoldi & C. La stessa intende tutelare i suoi diritti.

Indice  
Data  
Vr.

modificata

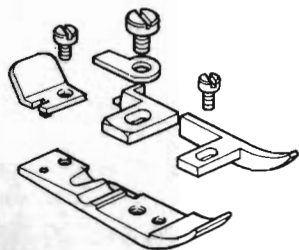
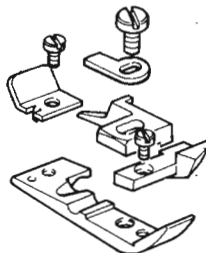
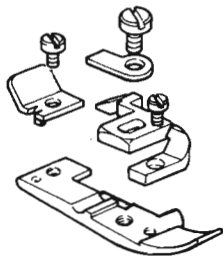
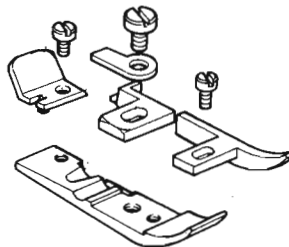
**202774-3-10**Serve per  
Serves for  
Pour machines  
Dient fuer327-28-1CD-02  
327-28-1CU-04  
028-28-01  
028-28-02  
028-28-04  
228-28-01  
228-28-02  
228-28-04*T5C***202787-3-11**Serve per  
Serves for  
Pour machines  
Dient fuer327-10-1CD-03  
327-10-1CD-04  
228-10-02  
228-10-03**202786-3-10**Serve per  
Serves for  
Pour machines  
Dient fuer327-10-1CD-02  
327-10-1CD-06  
028-10-02  
028-10-03  
028-10-04  
028-10-05  
228-10-01  
228-10-05  
228-10-06  
228-10-07**202938-3-11**Serve per  
Serves for  
Pour machines  
Dient fuer327-28-1CU-06  
028-28-03  
028-28-05  
028-28-06  
228-28-03  
228-28-05  
228-28-06*M2A*

Si rende noto che il contenuto della presente tavola non potrà essere utilizzato o rappresentato, né comunque che parzialmente senza il permesso scritto della proprietaria S.p.A. V. F. F. prima di legge. Pressa Integrale (tutte le sue direzioni).

modifiche:

Var.	Data	Inchiesta



**Rimoldi****PIEDINO****PRESSER FOOT****PIED PRESSEUR****DRUECKERFUSS**

Indice	TAB	<b>R300</b>
Data	Foglio 7	Segue F. 8

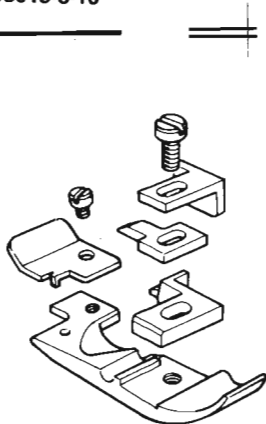
**203015-3-10**

Serve per  
Serves for  
Pour machines  
Dient fuer

327-00-1CD-06  
028-00-02  
228-00-04

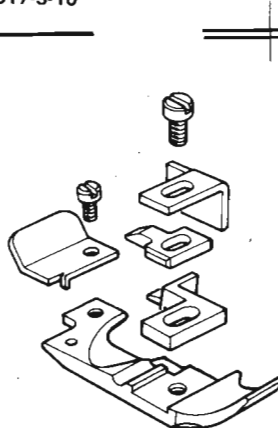
**203017-3-10**

Serve per  
Serves for  
Pour machines  
Dient fuer

327-00-1MD-33

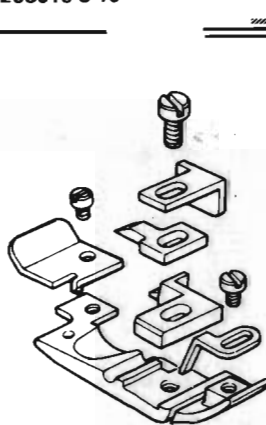
**203016-3-10**

Serve per  
Serves for  
Pour machines  
Dient fuer

327-01-1CD-03  
327-01-1CD-06  
028-01-03  
228-01-02

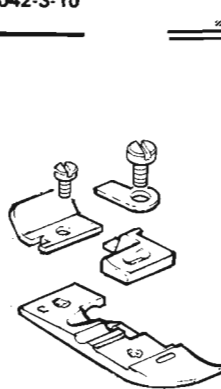
**203042-3-10**

Serve per  
Serves for  
Pour machines  
Dient fuer

327-01-1CD-03  
028-01-03  
228-01-02

Indice  
Data  
V.

Si rende noto che il contenuto della presente tavola non potrà essere utilizzato o riprodotto, né completamente o parzialmente senza l'autorizzazione scritta della proprietaria S.p.A. V. I. L. D. I. & C. La stessa intende tutelare i suoi diritti in forma di legge.



203050-3-10



Serve per  
Serves for  
Pour machines  
Dient fuer

327-00-1CD-25  
028-00-20  
028-30-03  
228-00-11

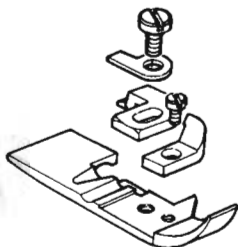

203077-3-10



Serve per  
Serves for  
Pour machines  
Dient fuer

327-00-1CD-26  
028-00-21  
028-00-23  
028-30-05  
028-30-06  
228-00-12



203053-3-10



Serve per  
Serves for  
Pour machines  
Dient fuer

028-30-04

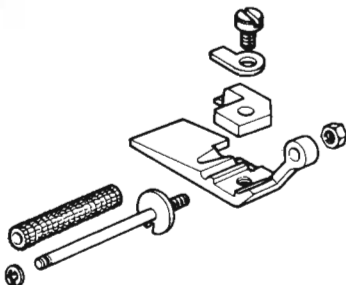

203154-3-10



Serve per  
Serves for  
Pour machines  
Dient fuer

327-29-1CD-04  
028-29-04

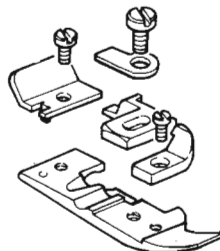

modifiche

Indice	Indice
V/	Date



Si rende nota che il contenuto della presente tavola non è un diritto di proprietà intellettuale e che gli stessi disegni possono essere riprodotti e utilizzati senza permesso dalla Rumoldi s.p.a. senza che questa sia tenuta a risarcire i danni. Rumoldi s.p.a. si riserva il diritto di tutelare i suoi diritti.



Indice
Data
Vr

modifiche

Si rende noto che il contenuto della presente tavola non potrà essere utilizzato o rappresentato né comunque divulgato a terzi o riprodotto in qualsiasi forma senza il permesso scritto della proprietaria S.p.A. V. R. Z.O.I. & C. La stessa intende tutelare i suoi diritti in forma di legge.

**Rumoldi**

PIEDINO

PRESSER FOOT

PIED PRESSEUR

DRUECKERFUSS

Indice				TAB	<b>R300</b>	
Data					Foglio 9	Segue F.10

**203157-3-10**

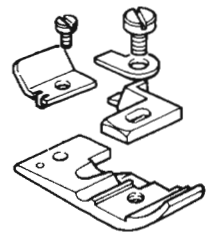
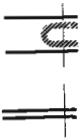

Serve per  
Serves for  
Pour machines  
Dient fuer

- 327-01-1CD-01
- 327-22-1CD-02
- 327-22-1CD-04
- 028-01-01

**203159-3-10**

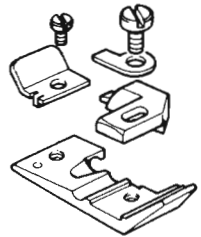

Serve per  
Serves for  
Pour machines  
Dient fuer

- 327-22-1CD-03
- 327-22-1CD-05

**203158-3-10**

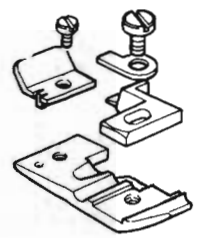

Serve per  
Serves for  
Pour machines  
Dient fuer

- 327-22-1CD-02
- 327-22-1CD-04

**203160-3-10**

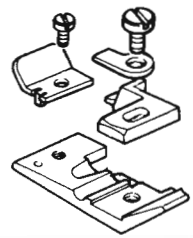

Serve per  
Serves for  
Pour machines  
Dient fuer

- 327-23-1CD-02
- 327-23-1CD-08



**Rumoldi**

PIEDINO

PRESSER FOOT

PIED PRESSEUR

DRUECKERFUSS

Indice

TAB

**R300**

Data

Foglio 11 | Segue F.12

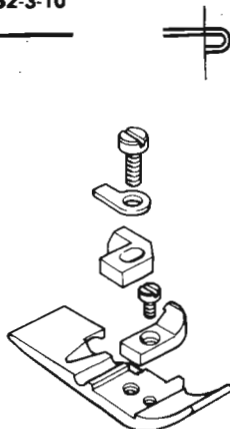
**203362-3-10**

Serve per  
Serves for  
Pour machines  
Dient fuer

327-00-1CD-09  
327-00-1CD-39  
028-00-06  
228-00-06  
228-00-17  
228-00-18

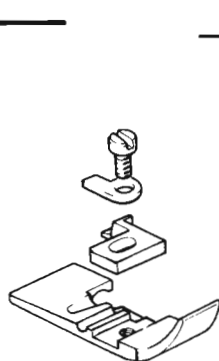
**203400-3-10**

Serve per  
Serves for  
Pour machines  
Dient fuer

028-30-02

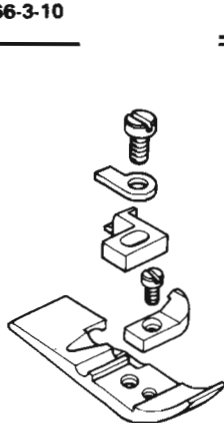
**203366-3-10**

Serve per  
Serves for  
Pour machines  
Dient fuer

327-00-1CD-10  
327-28-1CD-11  
028-00-07  
028-00-08  
228-00-07  
228-00-08

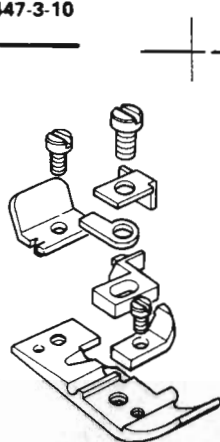
**203447-3-10**

Serve per  
Serves for  
Pour machines  
Dient fuer

327-00-2CD-12  
327-00-2CD-13  
327-00-2CD-34  
327-00-2CD-38  
327-00-2CD-44  
028-00-09  
028-00-10  
228-00-09  
228-00-10

Si rende noto che il contenuto della presente tavola non potrà essere utilizzato o rappresentato né copiato, né ristampato, né tradotto, né riprodotto, né modificato, né parzialmente senza permesso scritto della proprietaria S.p.A. V. L. DI & C. La stessa intende tutelare i suoi diritti in forma di legge.

Indice  
Data  
Vr.

modifiche

**Arnoldi**

PIEDINO

PRESSER FOOT

PIED PRESSEUR

DRUECKERFUSS

Indice	TAB	<b>R300</b>
Date	Foglio 12	Segue F.13

203556-3-10

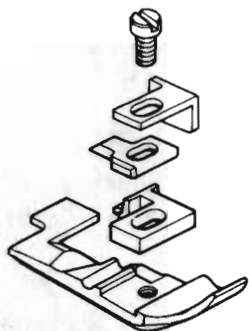

Serve per  
Serves for  
Pour machines  
Dient fuer

327-00-2CD-32  
327-00-2MD-37

203584-3-10

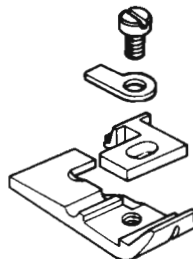

Serve per  
Serves for  
Pour machines  
Dient fuer

327-23-2CD-06

203558-3-10

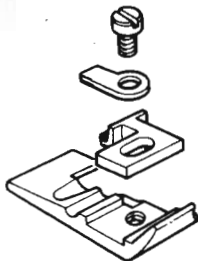

Serve per  
Serves for  
Pour machines  
Dient fuer

327-22-2CD-06

203585-3-10

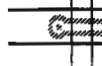
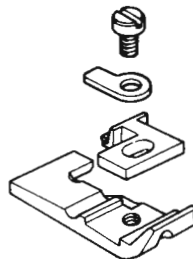

Serve per  
Serves for  
Pour machines  
Dient fuer

327-23-2CD-06

Si v'enda noto che il contenuto della presente tavola non potrà essere utilizzato o riprodotto senza permesso scritto dalla proprietaria S.p.A. V. F. Arnoldi & C. La stessa intende tutelare i suoi diritti.

Mod. F. 10

Indice	Date
V.	











**Arnold**

PIEDINO

PRESSER FOOT

PIED PRESSEUR

DRUECKERFUSS

Indice	TAB	<b>R300</b>
Data	Foglio 13	Segue F.14

203597-3-10

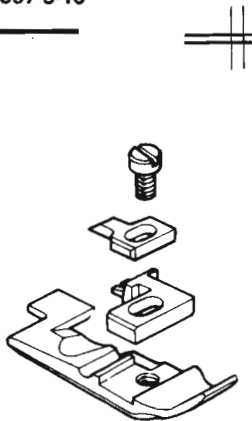

Serve per  
Serves for  
Pour machines  
Dient fuer

327-00-2CD-16  
327-00-2CD-41  
028-00-13

203721-3-10

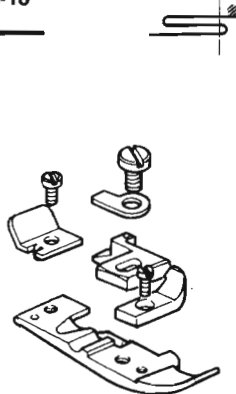

Serve per  
Serves for  
Pour machines  
Dient fuer

327-11-1CD-01  
028-11-01

203618-3-10

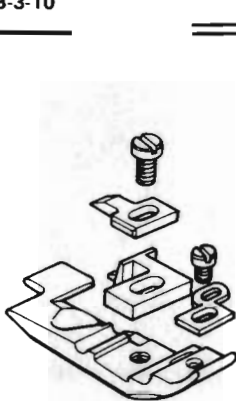

Serve per  
Serves for  
Pour machines  
Dient fuer

327-01-2CD-05  
028-01-05..

203765-3-10

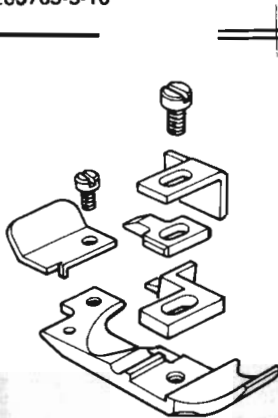

Serve per  
Serves for  
Pour machines  
Dient fuer

327-00-1MD-23  
327-00-1MD-34  
028-00-18

Si rende noto che il contenuto della presente tavola non potrà essere utilizzato o riprodotto senza permesso scritto dalla proprietaria S.p.A. V. Lodi & C. La stessa intende tutelare i suoi diritti in conformità di legge.

Indice  
Data  
Vr.  
modifiche



**Arnoldi**

PIEDINO

PRESSER FOOT

PIED PRESSEUR

DRUECKERFUSS

Indice	1	2	3	4	5	6	7	8	9	10	11	12	13	14	15	16	<b>R300</b>
Data																	Foglio 15   Segue F.16

203796-3-00

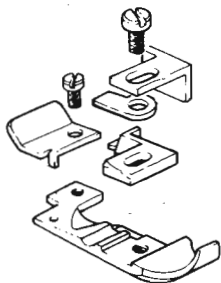

Serve per  
Serves for  
Pour machines  
Dient fuer

327-00-1CD-06/103-90  
028-00-02/103-90  
228-00-04/103-90

203803-3-10



Serve per  
Serves for  
Pour machines  
Dient fuer

327-00-1CD-27  
028-00-22

203800-3-10

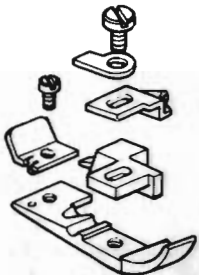

Serve per  
Serves for  
Pour machines  
Dient fuer

327-29-1CD-08  
028-29-07

203815-3-10

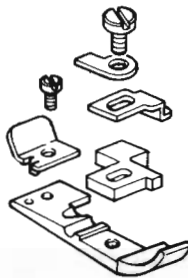

Serve per  
Serves for  
Pour machines  
Dient fuer

327-00-1CD-29  
028-00-24

Indice  
Data  
V.

modifiche

Si rende noto che il contenuto della presente tavola non potrà essere utilizzato o rappresentato né come disegno né come fotografia senza permesso scritto dalla proprietaria S.p.A. Arnoldi & C. La stessa intende tutelare i suoi diritti e firma di legge.



**Rumoldi****PIEDINO****PRESSER FOOT****PIED PRESSEUR****DRUECKERFUSS**

Indice	TAB	<b>R300</b>
Data	Foglio 16	Segue F17

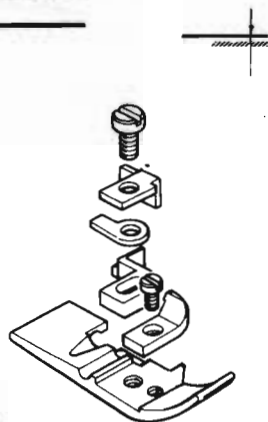
**203866-3-10**

Serve per  
Serves for  
Pour machines  
Dient fuer

227-34-03

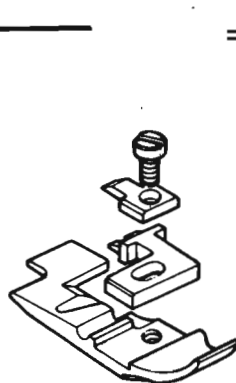
**204009-3-11**

Serve per  
Serves for  
Pour machines  
Dient fuer

327-00-2CD-18  
327-00-2MD-36  
028-00-15  
028-00-16

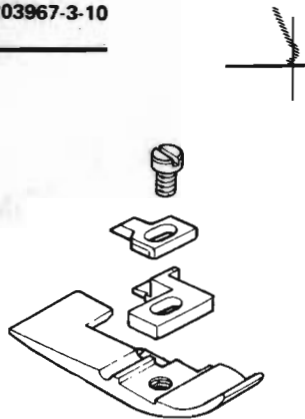
**203967-3-10**

Serve per  
Serves for  
Pour machines  
Dient fuer

227-34-01

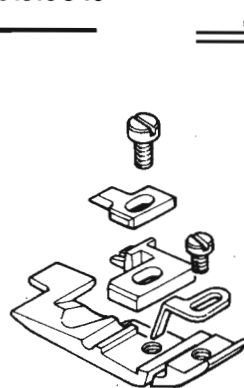
**204010-3-10**

Serve per  
Serves for  
Pour machines  
Dient fuer

327-01-2CD-06  
327-01-2MD-11  
028-01-06

Si rende noto che il contenuto della presente tavola  
non può essere ristampato o copiato senza permesso  
scritto dalla Rumoldi S.p.A. e che il presente disegno  
è di proprietà della Rumoldi S.p.A. e che il presente  
disegno è di proprietà della Rumoldi S.p.A. e che il  
presente disegno è di proprietà della Rumoldi S.p.A.

modifiche

Indice	Data	V.



**Remoldi****PIEDINO****PRESSER FOOT****PIED PRESSEUR****DRUECKERFUSS**

Indice

TAB

**R300**

Data

Foglio 17

Segue 18

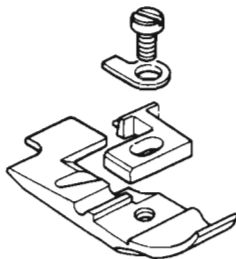
**204017-3-10**

Serve per  
Serves for  
Pour machines  
Dient fuer

327-00-2CD-18  
327-00-2MD-36  
028-00-15  
028-00-16

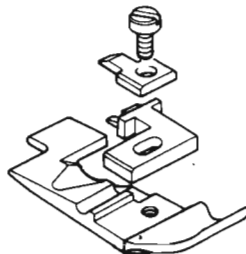
**204037-3-10**

Serve per  
Serves for  
Pour machines  
Dient fuer

327-00-2CD-14  
327-00-2CD-15  
327-00-2CD-17  
327-00-2CD-35  
327-00-2CD-39  
327-00-2CD-45  
327-00-2MD-20  
327-00-2MD-21  
028-00-11  
028-00-12  
028-00-14  
028-00-17

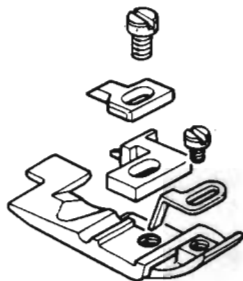
**204028-3-10**

Serve per  
Serves for  
Pour machines  
Dient fuer

327-01-2CD-05  
327-01-2CD-10  
327-01-2CD-12  
327-01-2CD-13  
327-01-2MD-07  
028-01-05  
028-01-07

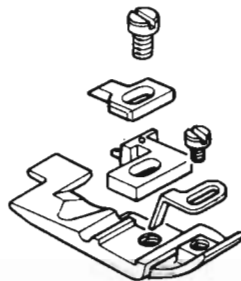
**204038-3-00**

Serve per  
Serves for  
Pour machines  
Dient fuer

327-01-2MD-07  
028-01-07

Indice  
Data  
V.

modifiche

Si vende noto che il contenuto della presente tavola è di proprietà esclusiva della Remoldi & C. La stessa intende tutelare i suoi diritti e norme di legge.

**Rimoldi****PIEDINO****PRESSER FOOT****PIED PRESSEUR****DRUECKERFUSS**

Indice	TAB	<b>R300</b>
Date	Foglio 18	Segue F19

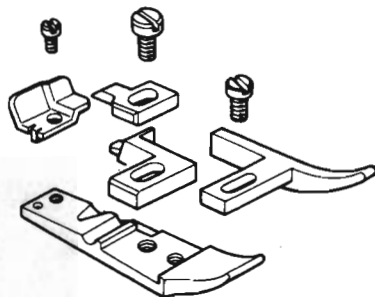
**204051-3-10**

Serve per  
Serves for  
Pour machines  
Dient fuer

327-34-1MD-02  
228-34-01

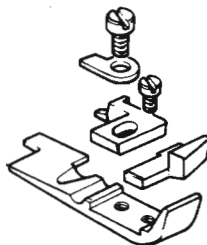
**204439-3-12**

Serve per  
Serves for  
Pour machines  
Dient fuer

228-10-04

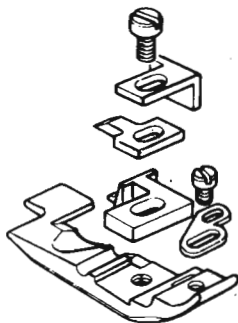
**204057-3-10**

Serve per  
Serves for  
Pour machines  
Dient fuer

327-01-2MD-07  
028-01-07

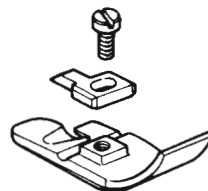
**204525-3-11**

Serve per  
Serves for  
Pour machines  
Dient fuer

028-28-09  
228-28-09

Si veda noto che il contenuto della presente tavola non potrà essere utilizzato o rappresentato né come intero né parzialmente senza l'autorizzazione scritta della proprietaria S.p.A. V. V. Di S. C. La stessa intende tutelare i suoi diritti e non si riserva il diritto di legge.

modifiche

V./r.	Indice	Data



**Rumoldi**

PIEDINO

PRESSER FOOT

PIED PRESSEUR

DRUECKERFUSS

Indice				TAB	<b>R300</b>
Date	Foglio 19			Segue F20	

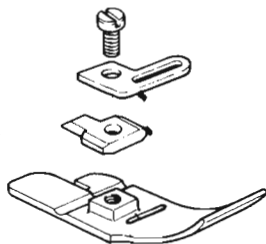
**204526-3-11**

Serve per  
Serves for  
Pour machines  
Dient fuer

028-29-08

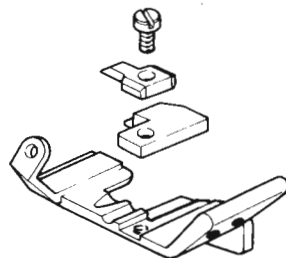
**204592-3-11**

Serve per  
Serves for  
Pour machines  
Dient fuer

028-28-10  
028-28-11  
228-28-08  
228-28-11

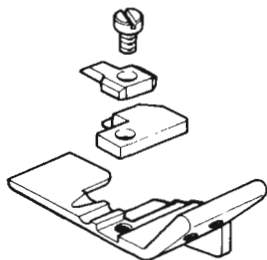
**204571-3-11**

Serve per  
Serves for  
Pour machines  
Dient fuer

028-28-10  
028-28-11  
228-28-08  
228-28-11

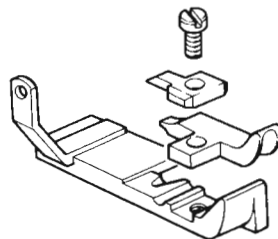
**204611-3-11**

Serve per  
Serves for  
Pour machines  
Dient fuer

028-00-19  
228-00-16

Si rende noto che il contenuto della presente tavola non potrà essere utilizzato o rappresentato in modo parziale o totale senza l'autorizzazione scritta della proprietaria S.p.A. V. P. Rumoldi & C. La stessa intende tutelare i suoi diritti. Firma di legge.

Indice  
Date  
Vr

modifiche

**204633-3-10**

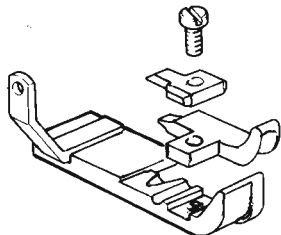

Serve per  
Serves for  
Pour machines  
Dient fuer

028-00-19  
228-00-16

**204826-3-10**

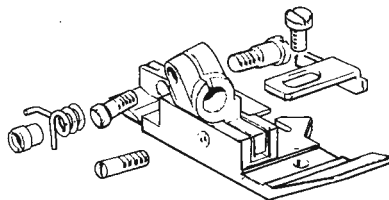

Serve per  
Serves for  
Pour machines  
Dient fuer

329-00-2CD-03

**204706-3-11**

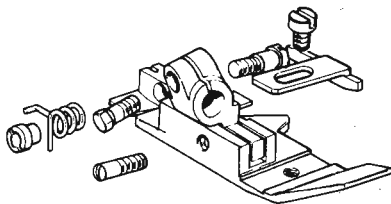

Serve per  
Serves for  
Pour machines  
Dient fuer

329-00-2CD-02

**204827-3-10**

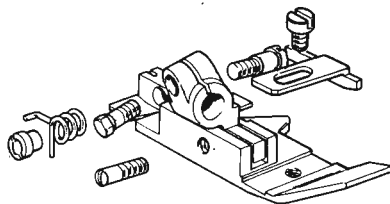

Serve per  
Serves for  
Pour machines  
Dient fuer

329-00-2CD-04

Si rende noto che il contenuto della presente tavola non potrà essere utilizzato o rappresentato, né comunque che parzialmente senza il permesso scritto della proprietà S.p.A. V. I. DI & C. La stessa intende tutelare i suoi diritti in forma di legge.

modifiche

V.	Data	Indice



*Rumoldi*

PIEDINO

PRESSER FOOT

PIED PRESSEUR

DRUECKERFUSS

Indice	TAB	<b>R300</b>
Data	Foglio 21	Segue F22

204828-3-10



Serve per  
Serves for  
Pour machines  
Dient fuer

329-22-2CD-02

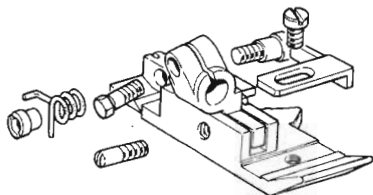

204873-3-11



Serve per  
Serves for  
Pour machines  
Dient fuer

329-12-2CD-02

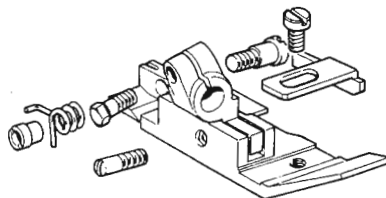

204829-3-10

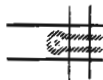

Serve per  
Serves for  
Pour machines  
Dient fuer

329-23-2CD-02

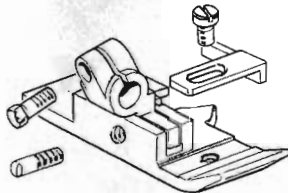

204875-3-11



Serve per  
Serves for  
Pour machines  
Dient fuer

329-22-2CD-03

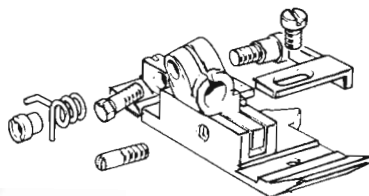

Si rende noto che il contenuto della presente tavola  
 non può essere riprodotto o ristampato integral-  
 mente o parzialmente senza l'autorizzazione scrit-  
 ta della proprietaria S.p.A. Rumoldi & C. La  
 stessa intende tutelare i suoi diritti.

Indice  
 Data  
 Vr

modelli



**Rumoldi**

PIEDINO

PRESSER FOOT

PIED PRESSEUR

DRUECKERFUSS

Indice	TAB	<b>R300</b>
Data	Foglio 23	Segue F24

**205034-3-11**

Serve per  
Serves for  
Pour machines  
Dient fuer

329-22-2CD-04

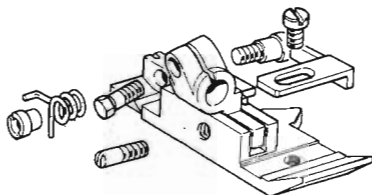
**205070-3-11**

Serve per  
Serves for  
Pour machines  
Dient fuer

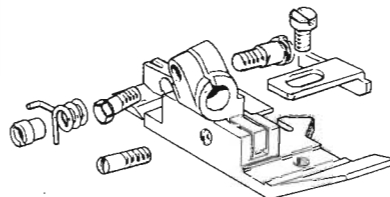
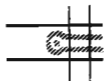
329-00-2CD-06  
329-00-2CD-13**205035-3-11**

Serve per  
Serves for  
Pour machines  
Dient fuer

329-23-2CD-04

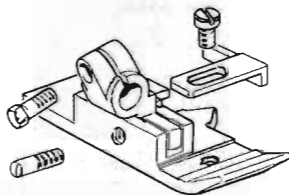
**205084-3-10**

Serve per  
Serves for  
Pour machines  
Dient fuer

329-00-2CD-09

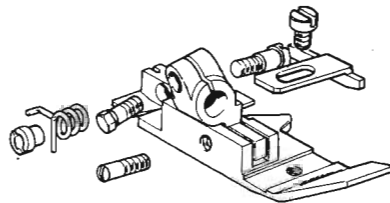

Si rende noto che il contenuto della presente tavola  
non è un brevetto, ma è un modello di riferimento  
marchio di vendita, senza alcun diritto di esclusiva  
mentre che parzialmente senza l'ausilio di una scrit-  
tura della proprietà S.p.A. V. R. DI & C. La  
stessa intende tutelare i suoi diritti come di legge.

Indice  
Data  
V.

modelltech



Rumoldi

PIEDINO

PRESSER FOOT

PIED PRESSEUR

DRUECKERFUSS

Indice

TAB

R300

Data

Foglio 24 Segue F. 25

205085-3-10



Serve per  
Serves for  
Pour machines  
Dient fuer

329-00-2CD-11

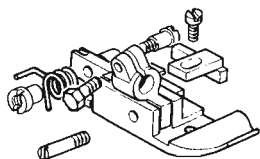

205110-3-11



Serve per  
Serves for  
Pour machines  
Dient fuer

329-00-2CD-07

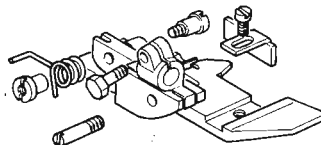

205103-3-10



Serve per  
Serves for  
Pour machines  
Dient fuer

329-00-2CD-08

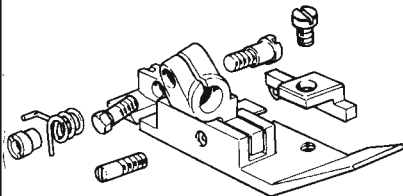

205118-3-11



Serve per  
Serves for  
Pour machines  
Dient fuer

329-00-2CD-10

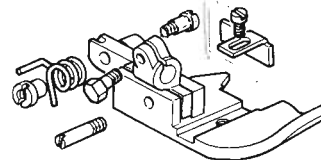

Si rende noto che il contenuto della presente tavola non potrà essere utilizzato o rappresentato né come disegno né come fotografia senza permesso scritto dalla proprietaria S.p.A. V. C. L. D. I. & C. La stessa intende tutelare i suoi diritti secondo le norme di legge.

modifiche

Indice	Data



**Remold**

PIEDINO

PRESSER FOOT

PIED PRESSEUR

DRUECKERFUSS

Indice				TAB	<b>R300</b>
Data				Foglio 25   Segue F26	

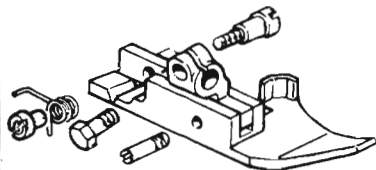
**205196-3-10**

Serve per  
Serves for  
Pour machines  
Dient fuer

330-00-1CD-01

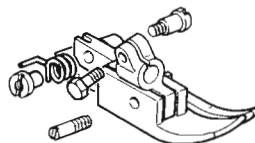
**205223-3-10**

Serve per  
Serves for  
Pour machines  
Dient fuer

330-00-1CD-02  
330-00-1CD-03

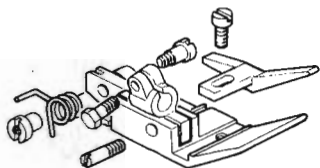
**205209-3-10**

Serve per  
Serves for  
Pour machines  
Dient fuer

330-00-1CD-02

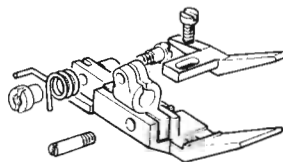
**205247-3-10**

Serve per  
Serves for  
Pour machines  
Dient fuer

330-00-1CD-03

Si rende noto che il contenuto della presente tavola  
 è di esclusiva proprietà della Remold S.p.A. e non  
 può essere divulgato, copiato, ristampato o riprodotto  
 in alcun modo senza l'autorizzazione scritta della  
 Remold S.p.A. La Remold S.p.A. non si assume  
 alcuna responsabilità per danni di ogni natura  
 derivanti dall'uso non autorizzato di questa  
 tavola.

Indice  
Data  
Vr

modifichim

**Rimoldi**

PIEDINO

PRESSER FOOT

PIED PRESSEUR

DRUECKERFUSS

Indice	TAB	<b>R300</b>
Date	Foglio 26	Segue F 27

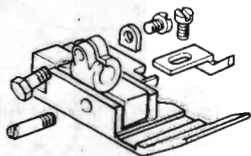
**205346-3-10**

Serve per  
Serves for  
Pour machines  
Dient fuer

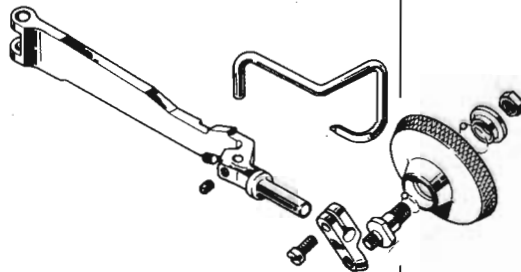
**330-22-1CD-01****205471-4-00**

Serve per  
Serves for  
Pour machines  
Dient fuer

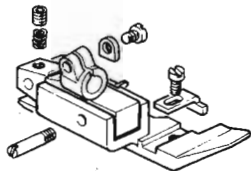
**028-00-26****205418-3-10**

Serve per  
Serves for  
Pour machines  
Dient fuer

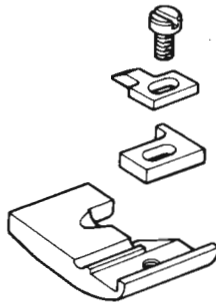
**330-12-1CD-01**  
**330-12-1CD-03****205503-3-00**

Serve per  
Serves for  
Pour machines  
Dient fuer

**327-01-1MD-09**

Si rende noto che il contenuto della presente tavola  
è di proprietà esclusiva di Rimoldi & C. La  
reproduzione o l'uso non autorizzato senza  
il permesso scritto della Rimoldi & C. La  
reproduzione o l'uso non autorizzato senza  
il permesso scritto della Rimoldi & C. La  
reproduzione o l'uso non autorizzato senza  
il permesso scritto della Rimoldi & C. La

modifiche

Indice

Data

V.

--

--

--

--

--

--

--

--

--

--

--

--

--

--

--

--

--

--

--

--

--

--

--

--

--

--

--

--

--

--

--

*Remold*

PIEDINO

PRESSER FOOT

PIED PRESSEUR

DRUECKERFUSS

Indice	TAB	<b>R300</b>
Data	Foglio 27	Segue F.28

205595-3-10

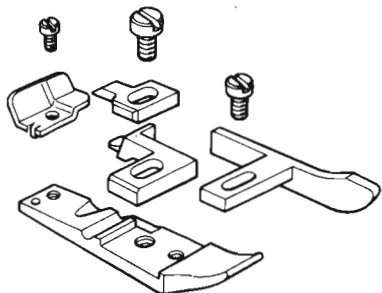

Serve per  
Serves for  
Pour machines  
Dient fuer

327-34-1MD-03

662

205607-3-00

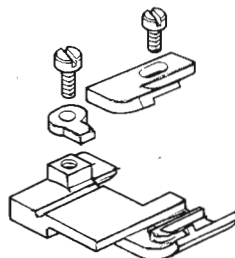

Serve per  
Serves for  
Pour machines  
Dient fuer

327-49-1MD-01

205604-3-00

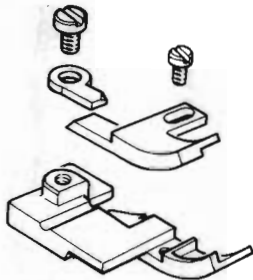

Serve per  
Serves for  
Pour machines  
Dient fuer

327-40-1MD-01

205710-3-00

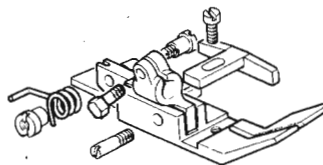

Serve per  
Serves for  
Pour machines  
Dient fuer

330-00-1CD-04

Indice  
Data  
Vr.

modifiche

Si rende noto che il contenuto della presente tavola è di esclusiva proprietà della Remold S.p.A. e non può essere in alcun modo divulgato, a terzi o riprodotto, senza l'autorizzazione scritta della proprietaria S.p.A. La Remold S.p.A. non si assume alcuna responsabilità e non intende tutelare i suoi diritti, come si legge...



**Rimoldi**

PIEDINO

PRESSER FOOT

PIED PRESSEUR

DRUECKERFUSS

Indice	TAB	<b>R300</b>
Data	Foglio 29	Segue F.30

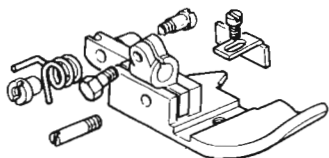
**206046-3-01**

Serve per  
Serves for  
Pour machines  
Dient fuer

329-00-3MU-01

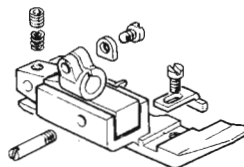
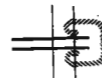
**206231-3-00**

Serve per  
Serves for  
Pour machines  
Dient fuer

330-12-2CD-02

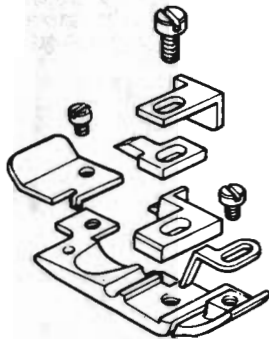
**206140-3-00**

Serve per  
Serves for  
Pour machines  
Dient fuer

327-34-1CD-01

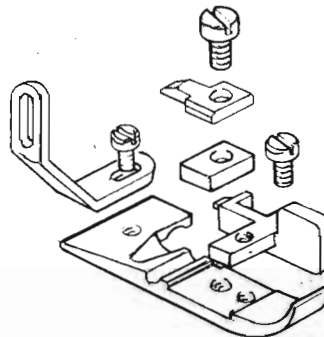
**207046-3-00**

Serve per  
Serves for  
Pour machines  
Dient fuer

327-11-1CD-02

Indice  
Data  
V.:

Si rende noto che il contenuto della presente tavola  
non può essere copiato, ristampato, riprodotto, o  
in alcun modo divulgato a terzi o riprodotto, senza  
l'autorizzazione scritta della Rimoldi S.p.A. in  
quanto a tale riguardo, i suoi diritti vengono di legge



920789-3-10

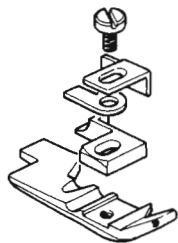

Serve per  
Serves for  
Pour machines  
Dient fuer

327-00-1CD-02/103-90  
327-00-1CD-05/103-90  
028-00-04/103-90  
228-00-02/103-90  
228-00-14/103-90

920810-3-10

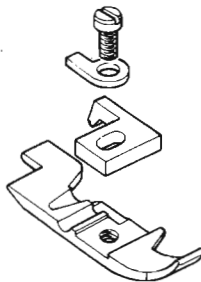

Serve per  
Serves for  
Pour machines  
Dient fuer

327-00-1CD-03/103-90  
028-00-05/103-90  
228-00-03/103-90

920795-3-10

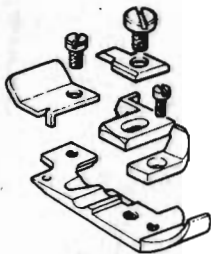

Serve per  
Serves for  
Pour machines  
Dient fuer

327-00-1CD-31/103-90  
228-00-15/103-90

920835-3-00

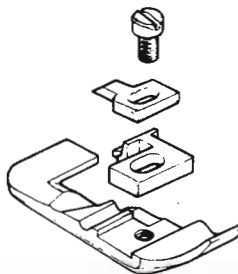

Serve per  
Serves for  
Pour machines  
Dient fuer

327-00-2CD-14/108-91  
327-00-2CD-15/108-91  
327-00-2CD-17/108-91  
327-00-2CD-18/108-91  
327-00-2MD-21/108-91  
327-00-2MD-36/108-91  
028-00-11/108-90  
028-00-12/108-90  
028-00-14/108-90  
028-00-15/108-90  
028-00-16/108-90

Indice  
Date  
Vr

Si rende noto che il contenuto della presente tavola non potrà essere utilizzato o rappresentato né comunque divulgato a terzi o riprodotto integralmente senza il permesso scritto della proprietà della stessa. La stessa intende tutelare i suoi diritti.



Si rende noto che il contenuto della presente tavola non potrà essere utilizzato o rappresentato né con mezzi meccanici né elettronicamente senza il permesso scritto della proprietaria S.p.A. V. F. Di & C. La stessa intende tutelare i suoi diritti.

Indice	Modifiche
V.	

920854-3-00

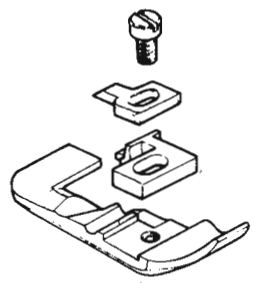

Serve per  
Serves for  
Pour machines  
Dient fuer

- 327-00-2CD-16/108-91
- 327-00-2CD-32/108-91
- 028-00-13/108-90

920884-3-10

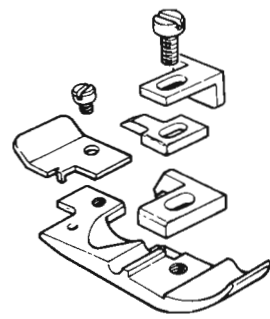

Serve per  
Serves for  
Pour machines  
Dient fuer

- 327-00-1CD-30/103-90
- 028-00-25/103-90
- 228-00-13/103-90

234

920860-3-00

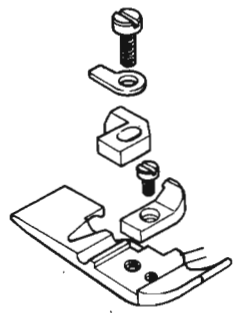

Serve per  
Serves for  
Pour machines  
Dient fuer

- 327-00-1CD-25/103-90

921352-3-10

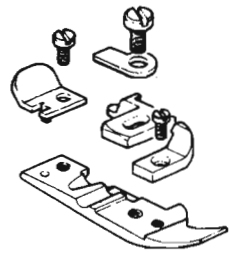

Serve per  
Serves for  
Pour machines  
Dient fuer

- 327-00-1CD-01/135-81
- 327-00-1CD-07/135-81
- 028-00-01/135-80
- 028-00-03/135-80
- 228-00-01/135-80
- 228-00-05/135-80





Indice
Data
Vr

modulisch-

Si rende noto che il contenuto della presente tavola non potrà essere utilizzato o rappresentato in alcuna maniera divulgata, a terzi o riprodotto in qualsiasi forma, senza il permesso scritto della proprietaria S.p.A. V. Riva, 31 & C. La stessa intende tutelare i suoi diritti a norma di legge.

**921381-3-10**

Serve per  
Serves for  
Pour machines  
Dient fuer

327-00-1CD-02/135-81  
228-00-14/135-80

**921383-3-10**

Serve per  
Serves for  
Pour machines  
Dient fuer

327-00-1CD-03/135-81  
028-00-05/135-80

**921382-3-10**

Serve per  
Serves for  
Pour machines  
Dient fuer

327-00-1CD-05/135-81  
028-00-04/135-80  
228-00-02/135-80

**921395-3-11**

Serve per  
Serves for  
Pour machines  
Dient fuer

327-28-1CU-06/135-81  
028-28-03/135-80  
028-28-05/135-80  
028-28-06/135-80  
228-28-03/135-80  
228-28-05/135-80  
228-28-06/135-80

**921396-3-10**

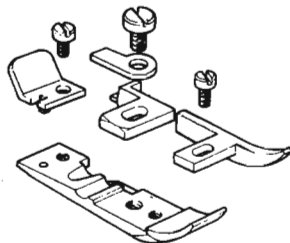

Serve per  
Serves for  
Pour machines  
Dient fuer

- 327-28-1CD-02/135-81
- 327-28-1CU-04/135-81
- 028-28-01/135-80
- 028-28-02/135-80
- 028-28-04/135-80
- 228-28-01/135-80
- 228-28-02/135-80
- 228-28-04/135-80

**921404-3-10**

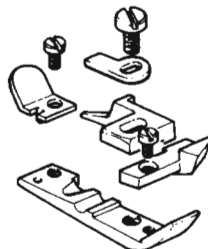

Serve per  
Serves for  
Pour machines  
Dient fuer

- 327-10-1CD-03/135-81
- 327-10-1CD-04/135-81
- 228-10-02/135-80
- 228-10-03/135-80

**921403-3-10**

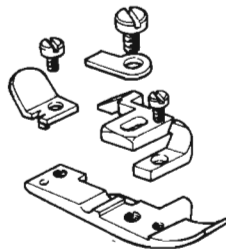

Serve per  
Serves for  
Pour machines  
Dient fuer

- 327-10-1CD-02/135-81
- 327-10-1CD-06/135-81
- 028-10-02/135-80
- 028-10-03/135-80
- 028-10-04/135-80
- 028-10-05/135-80
- 228-10-01/135-80
- 228-10-05/135-80
- 228-10-06/135-80
- 228-10-07/135-80

**921417-3-10**

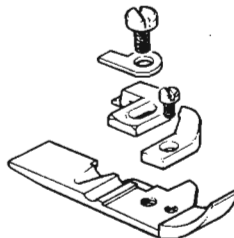

Serve per  
Serves for  
Pour machines  
Dient fuer

- 327-00-1CD-25/135-81

Si rende noto che il contenuto della presente tavola non potrà essere utilizzato o riprodotto senza permesso né con qualunque divieto a terzi o ristretto diritto di ristampare. La presente tavola è di proprietà della Rimoldi S.p.A. e con la stessa invade tutelare i suoi diritti a norma di legge.

modifiche

Indice	Data	Vr



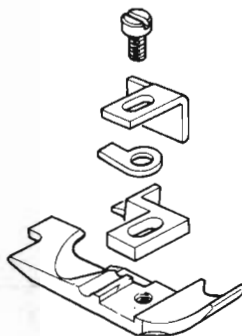

**Rimoldi****PIEDINO****PRESSER FOOT****PIED PRESSEUR****DRUECKERFUSS**

In d i c e				T A B E L L A	<b>R 300</b>
Data				Foglio 35	Segue F.36

**921422-3-10**

Serve per  
Serves for  
Pour machines  
Dient fuer

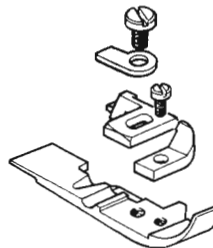
327-00-1CD-06/135-81  
028-00-02/135-80  
228-00-04 /135-80

**921437-3-10**

Serve per  
Serves for  
Pour machines  
Dient fuer

327-28-1CD-11/135-81  
028-00-08/135-80  
228-00-08/135-80

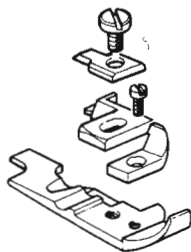
**921426-3-10**

Serve per  
Serves for  
Pour machines  
Dient fuer

327-00-1CD-31/135-81  
228-00-15/135-80

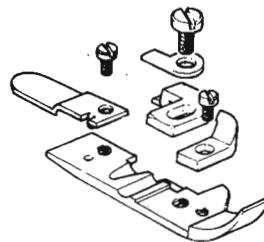
**921438-3-10**

Serve per  
Serves for  
Pour machines  
Dient fuer

327-00-1CD-09/135-81/137-81  
327-00-1CD-39/135-81/137-81  
028-00-06/135-80/137-80  
228-00-06/135-80/137-80  
228-00-17/135-80/137-80

Indice  
Data  
Vr

Indice  
Data  
Vr

Si rende noto che il contenuto della presente tavola  
non è destinato a essere divulgato a terzi o riprodotto  
integralmente o parzialmente senza l'autorizzazione scritta  
della stessa azienda tutelare i suoi diritti a norma di legge.

921439-3-10

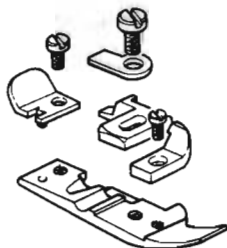

Serve per  
Serves for  
Pour machines  
Dient fuer

327-00-1CD-10/135-81/137-81  
028-00-07/135-80/137-80  
228-00-07/135-80/137-80

921453-3-10

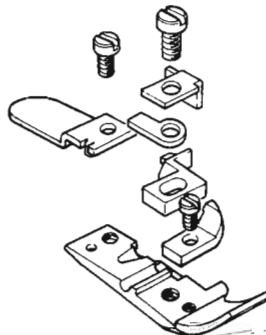

Serve per  
Serves for  
Pour machines  
Dient fuer

327-00-2CD-12/135-81  
327-00-2CD-18/135-81/137-81  
327-00-2CD-34/135-81/137-81  
028-00-09/135-80/137-80  
228-00-09/135-80/137-80

921440-3-10

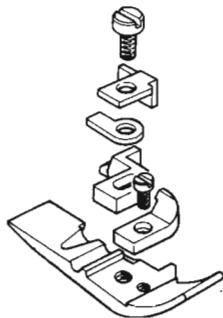

Serve per  
Serves for  
Pour machines  
Dient fuer

327-28-1CD-07/135-81  
028-28-07/135-80  
228-28-07/135-80

921455-3-10

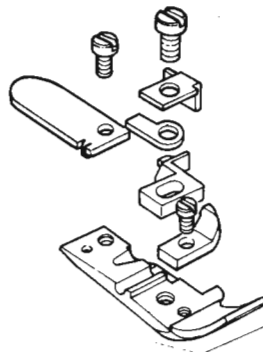

Serve per  
Serves for  
Pour machines  
Dient fuer

327-00-2CD-13/135-81/137-81  
028-00-10/135-80/137-80  
228-00-10/135-80/137-80

Si rende noto che il contenuto delle presentate tavole non potrà essere utilizzato, in tutto o in parte, senza permesso scritto dalla Rumoldi S.p.A. Le presentate tavole sono di proprietà della Rumoldi S.p.A. e non possono essere ristampate, riprodotte o pubblicate in qualsiasi forma senza permesso scritto dalla Rumoldi S.p.A.

modifiche

Indice	
Data	
V.	



















*Remoldi*

PIEDINO

PRESSER FOOT

PIED PRESSEUR

DRUECKERFUSS

Indice		T.A. 81	<b>R300</b>
Data	Foglio 37		

921530-3-11



Serve per  
Serves for  
Pour machines  
Dient fuer

228-00-18/135-80/137-80

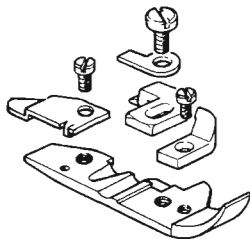

923839-3-00



Serve per  
Serves for  
Pour machines  
Dient fuer

327-28-1CD-09/135-81  
228-28-10/135-80

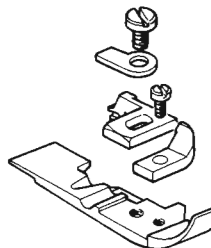

923783-3-00



Serve per  
Serves for  
Pour machines  
Dient fuer

327-00-1MD-23/135-81  
028-00-18/135-80

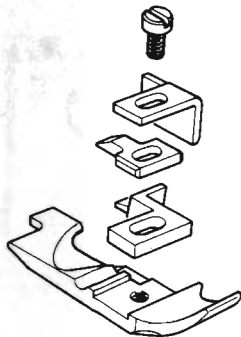

923880-3-00



Serve per  
Serves for  
Pour machines  
Dient fuer

327-00-2CD-41/135-81

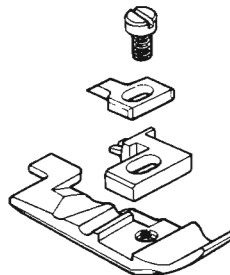

Indice  
Data  
V.

Modifiche

Si rende noto che il contenuto della presente tavola non potrà essere utilizzato, appreso, copiato, né in alcun modo divulgato a terzi o riprodotto, sia integralmente che parzialmente, senza l'autorizzazione scritta della stessa, la quale si riserva espressamente il diritto di legge. La stessa intende tutelare i suoi diritti.

**Rimoldi****PIEDINO****PRESSER FOOT****PIED PRESSEUR****DRUECKERFUSS**

Indice				TAB	<b>R300</b>
Date	Foglio 38			Segue F 39	

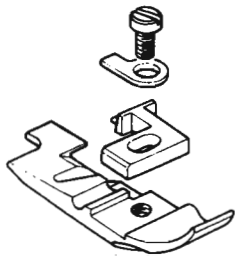
**923885-3-00**

Serve per  
Serves for  
Pour machines  
Dient fuer

327-00-2MD-36/135-81  
028-00-16/135-80

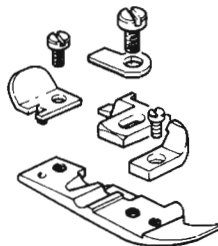
**923901-3-00**

Serve per  
Serves for  
Pour machines  
Dient fuer

028-00-01/135-80  
228-00-01/135-80

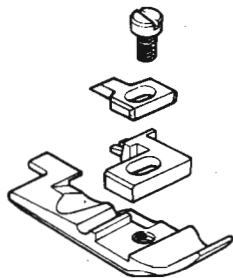
**923887-3-00**

Serve per  
Serves for  
Pour machines  
Dient fuer

327-00-2MD-20/135-81  
028-00-17/135-80

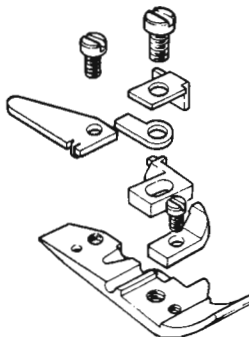
**923910-3-00**

Serve per  
Serves for  
Pour machines  
Dient fuer

327-00-1CD-09/135-81/137-81  
327-00-1CD-39/135-81/137-81  
028-00-06/135-80/137-80  
228-00-06/135-80  
228-00-17/135-80

Si vende noto che il contenuto della presente tavola non potrà essere utilizzato a terzi o riprodotto senza autorizzazione della proprietaria S.p.A. V. D. I. & C. La stessa intende tutelare i suoi diritti in conformità della legge.

modifich.

Indice	
Data	
V.	

**Renoldi****PIEDINO****PRESSER FOOT****PIED PRESSEUR****DRUECKERFUSS**

In d'ice	TAB	<b>R300</b>
Data	Foglio 39	

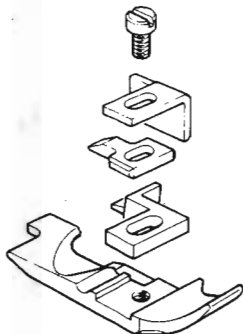
**926781-3-00**

Serve per  
Serves for  
Pour machines  
Dient fuer

327-00-1CD-30/135-81  
327-00-1MD-33/135-81  
028-00-25/135-80  
228-00-13/135-80

*BVA 4*

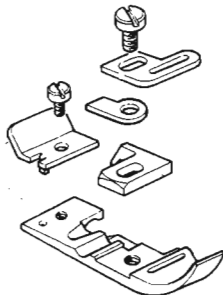
**927252-3-00**

Serve per  
Serves for  
Pour machines  
Dient fuer

327-00-1CD-01/103-90  
327-00-1CD-07/103-90

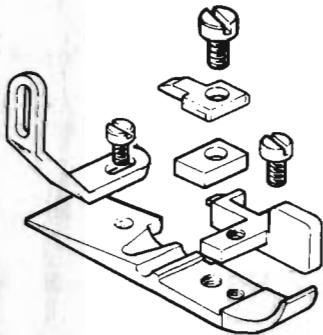
**926900-3-00**

Serve per  
Serves for  
Pour machines  
Dient fuer

327-11-1CD-02/135-81

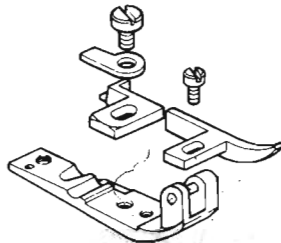
**941090-3-00**

Serve per  
Serves for  
Pour machines  
Dient fuer

**228-28-12**

Si vende solo che il contenuto della presente tavola.  
 non sia in tutto o in parte, né per intero, né in  
 qualunque diviso a terzi o riprodotta, integral-  
 mente o parzialmente senza il permesso scritto  
 della Renoldi S.p.A. in via S. Felice 10, 37069  
 Verona. La stessa intende tutelare i suoi diritti.

Modifiche  
Indice  
Data  
V.  
V.



