



**Teileliste und Näheinrichtungen  
Spare Parts List and Sewing Equipment**

**975 - 1 - 1**

**DÜRKOPP ADLER AG**

---

Teile-/Part.-No.: 0791 975801

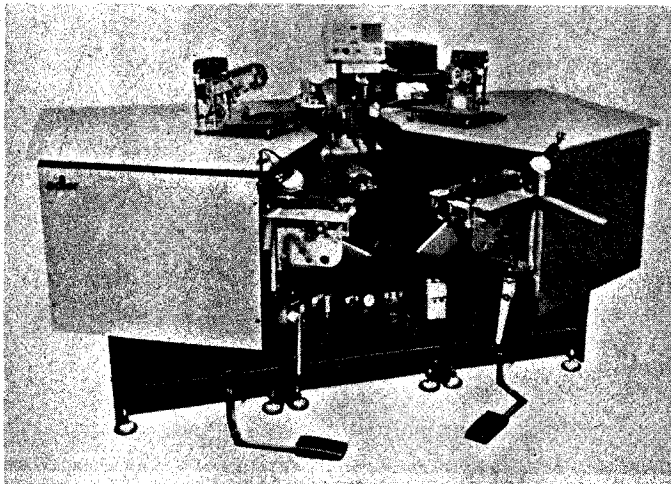

975-1-1/.

Typ:  
 Variant:  
 Variante

Elektrische Ausführung:  
 Electrical equipment:  
 Exécution électrique:  
 Equipo eléctrico:

- 3x380V, 50 Hz, - 1
- 3x220V, 50 Hz, - 2
- 3x220V, 60 Hz, - 3
- 3x415V, 50 Hz, - 4

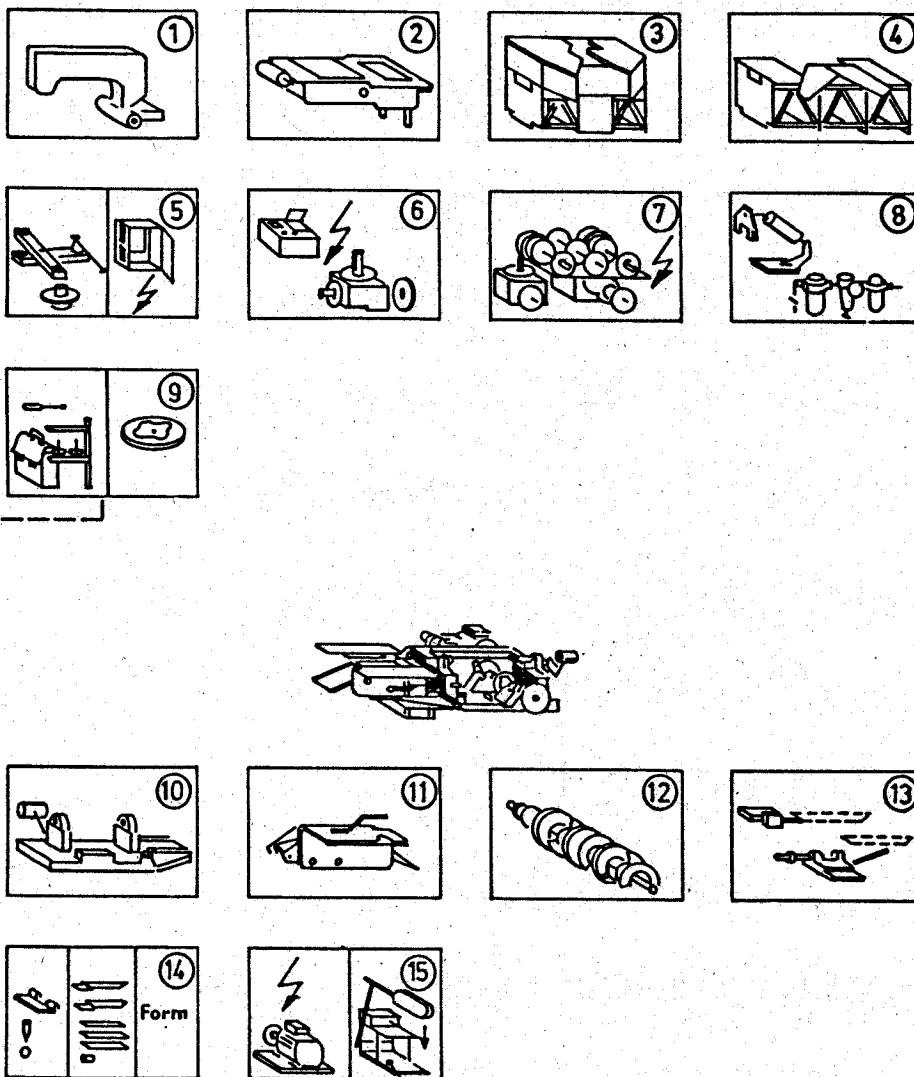

① + ② = 975 43 100 4 ①

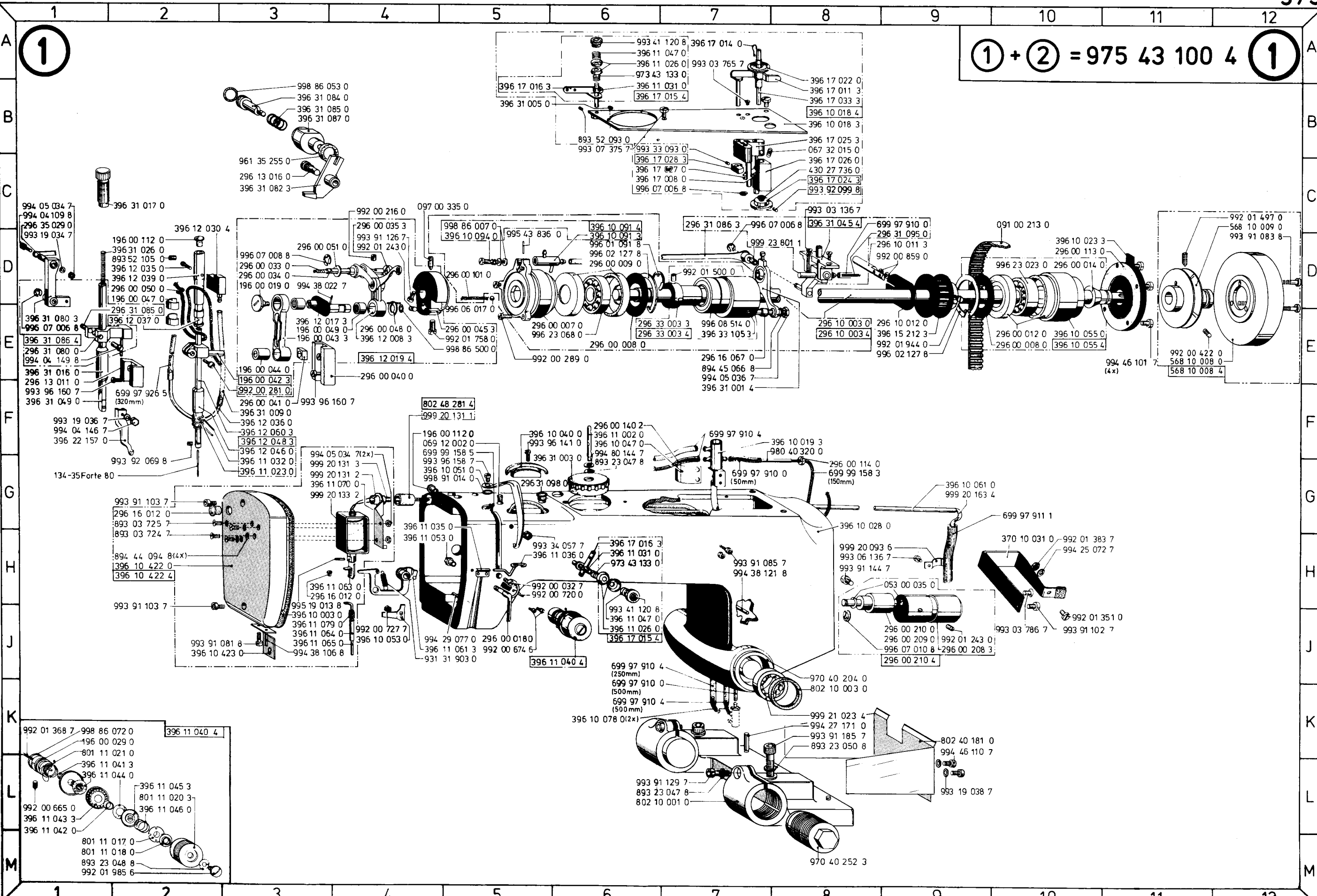

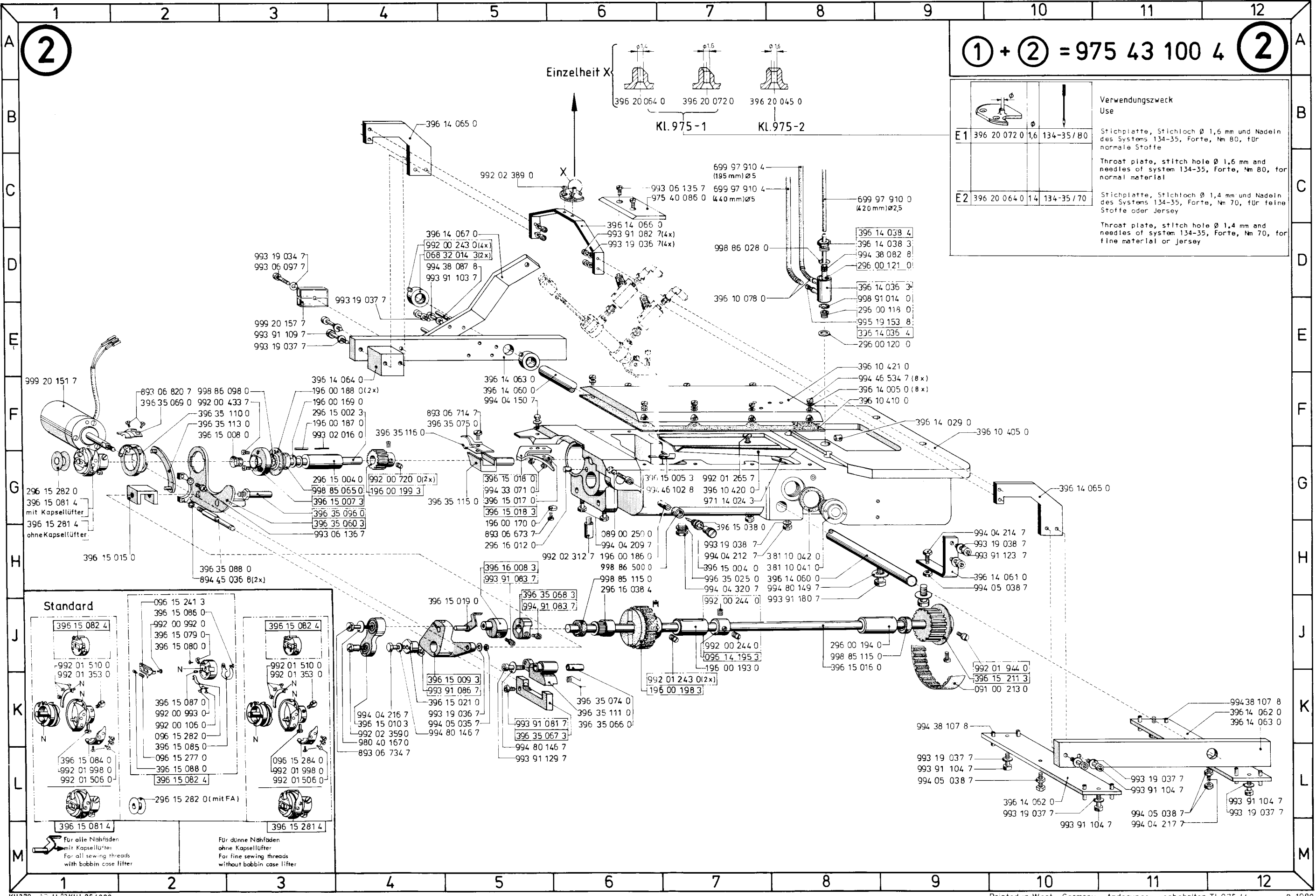

① + ② = 975 43 100 4 ②

	Verwendungszweck Use	
E1	396 20 072 0	1,6 134-35/80
E2	396 20 064 0	1,4 134-35/70

Stichplatte, Stichloch Ø 1,6 mm und Nadeln des Systems 134-35, Forte, Nm 80, für normale Stoffe  
Throat plate, stitch hole Ø 1,6 mm and needles of system 134-35, Forte, Nm 80, for normal material

Stichplatte, Stichloch Ø 1,4 mm und Nadeln des Systems 134-35, Forte, Nm 70, für feine Stoffe oder Jersey  
Throat plate, stitch hole Ø 1,4 mm and needles of system 134-35, Forte, Nm 70, for fine material or Jersey

**Standard**

<p>396 15 082 4</p> <p>992 01 510 0 992 01 353 0</p> <p>396 15 087 0 992 00 993 0 992 00 106 0 096 15 282 0 396 15 085 0 096 15 277 0 396 15 088 0 396 15 082 4</p> <p>396 15 084 0 992 01 998 0 992 01 506 0</p> <p>396 15 081 4</p> <p>Für alle Nähfäden mit Kapsellüfter For all sewing threads with bobbin case lifter</p>	<p>096 15 241 3 396 15 086 0 992 00 992 0 396 15 079 0 396 15 080 0</p> <p>396 15 087 0 992 00 993 0 992 00 106 0 096 15 282 0 396 15 085 0 096 15 277 0 396 15 088 0 396 15 082 4</p> <p>096 15 284 0 992 01 998 0 992 01 506 0</p> <p>296 15 282 0 (mit FA)</p> <p>396 15 081 4</p> <p>Für dünne Nähfäden ohne Kapsellüfter For fine sewing threads without bobbin case lifter</p>	<p>396 15 082 4</p> <p>992 01 510 0 992 01 353 0</p> <p>396 15 087 0 992 00 993 0 992 00 106 0 096 15 282 0 396 15 085 0 096 15 277 0 396 15 088 0 396 15 082 4</p> <p>096 15 284 0 992 01 998 0 992 01 506 0</p> <p>396 15 281 4</p> <p>Für alle Nähfäden mit Kapsellüfter For all sewing threads with bobbin case lifter</p>
--	--	--

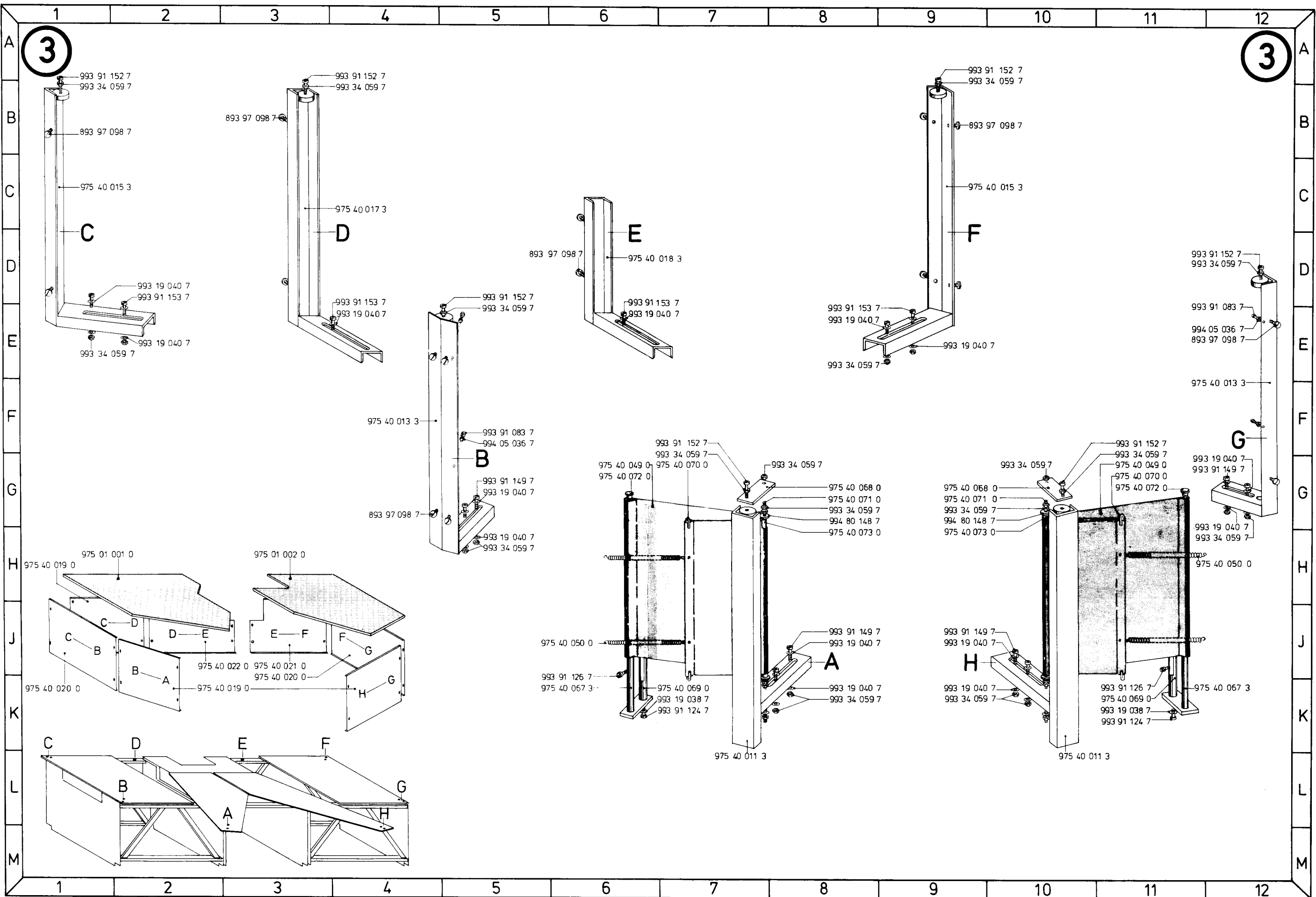



5

L = R  
links left = rechts right  
gauche gauche = droite droite  
izquierda izquierda = derecha derecha

5

### Schaltschrank 975 48 011 4

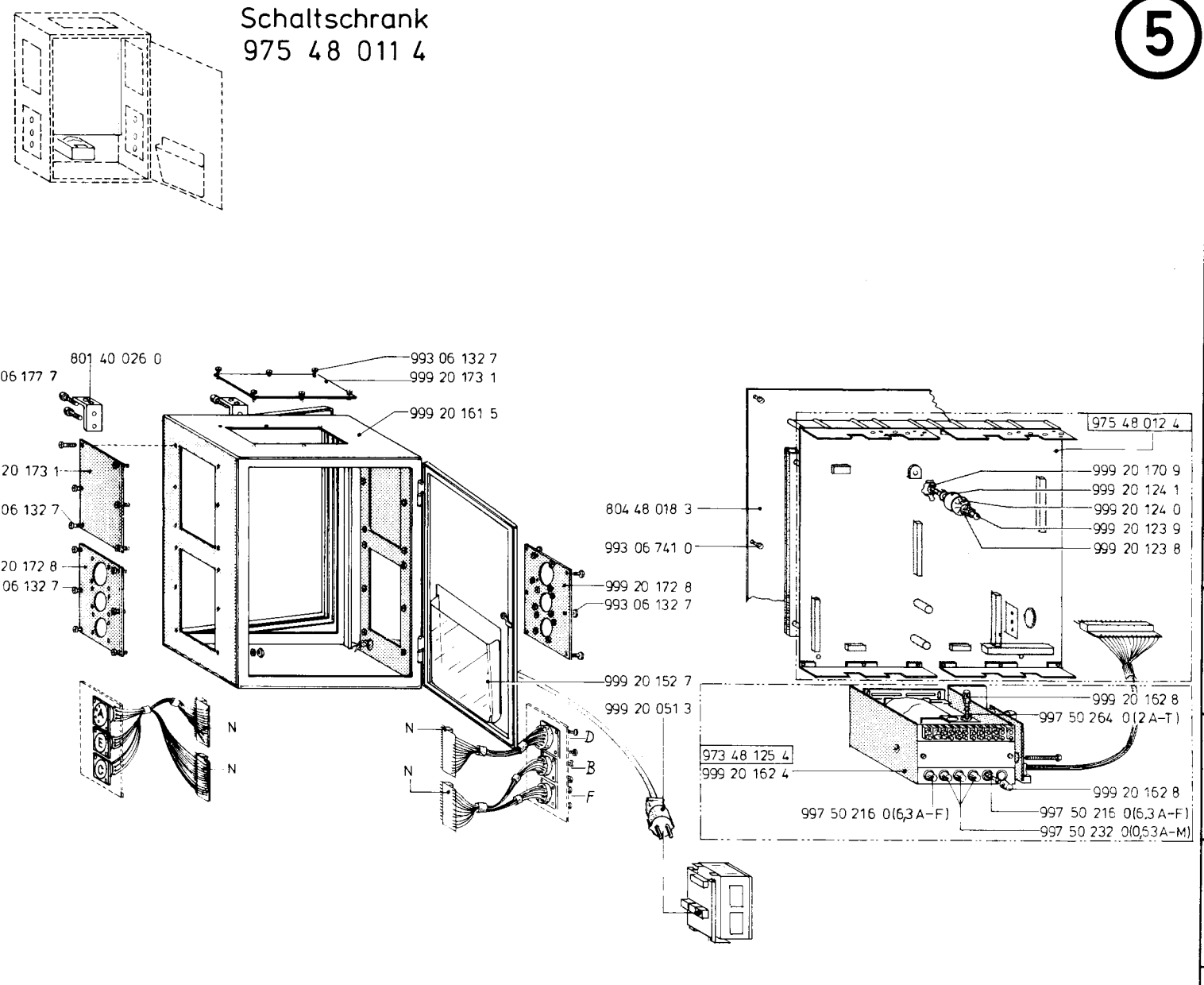
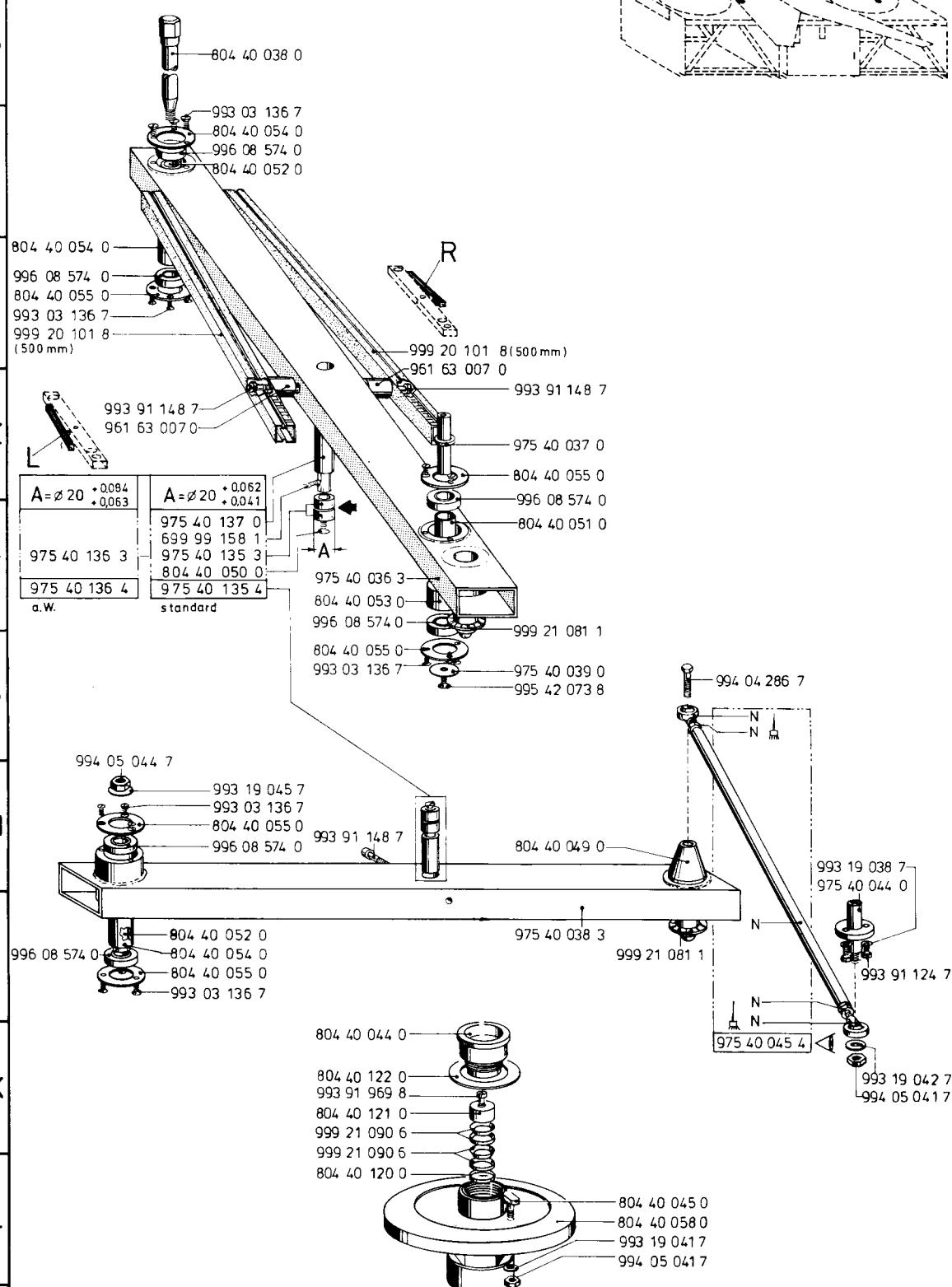

### Vorschalttrafo

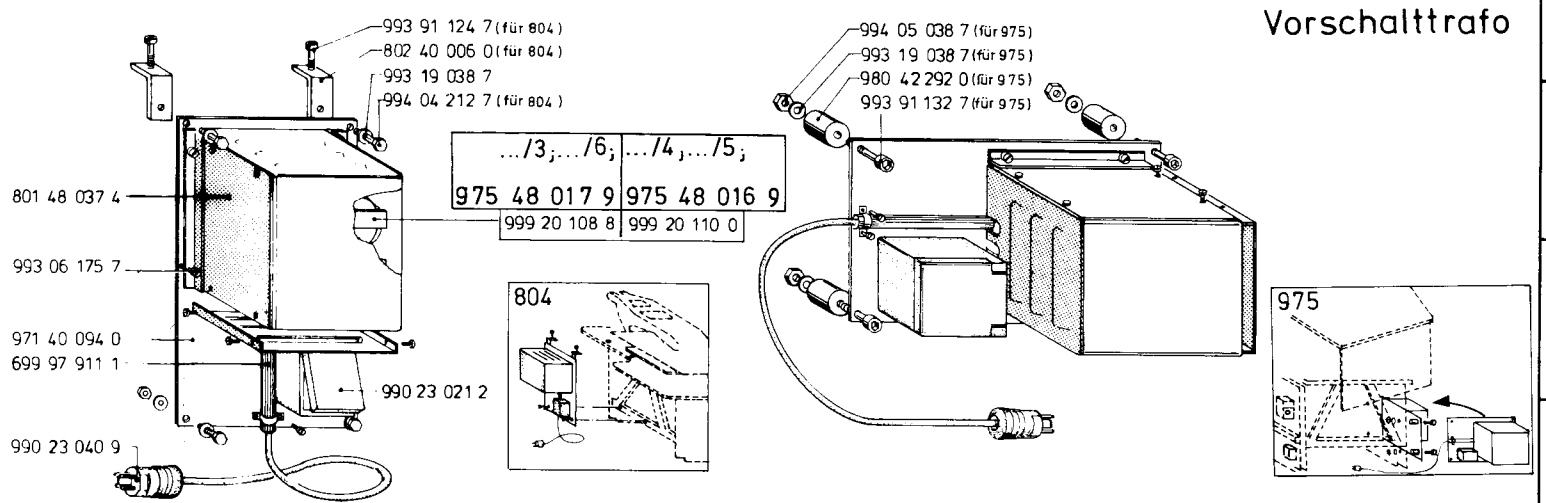

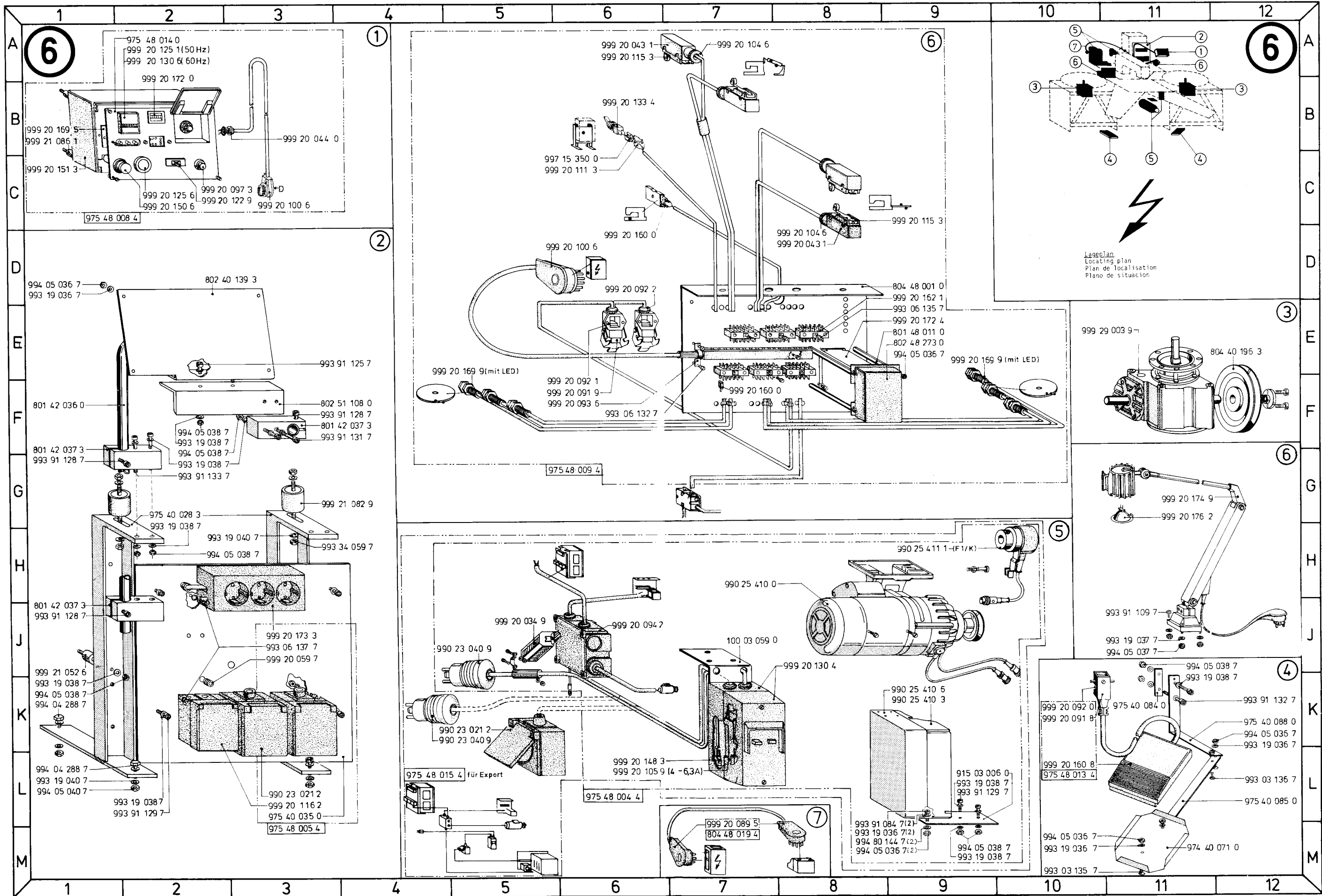

Lageplan  
 Locating plan  
 Plan de localisation  
 Plano de situacion



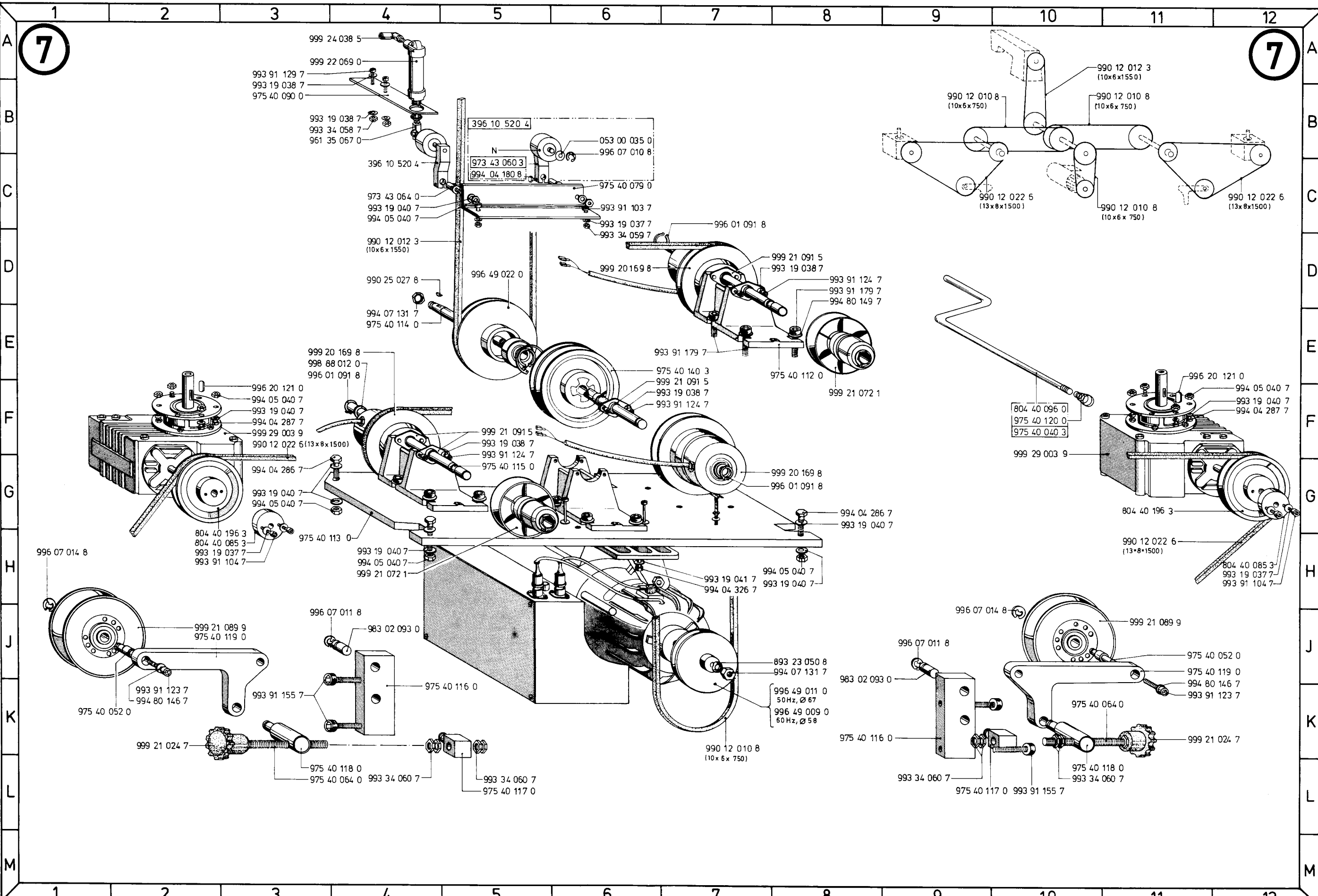

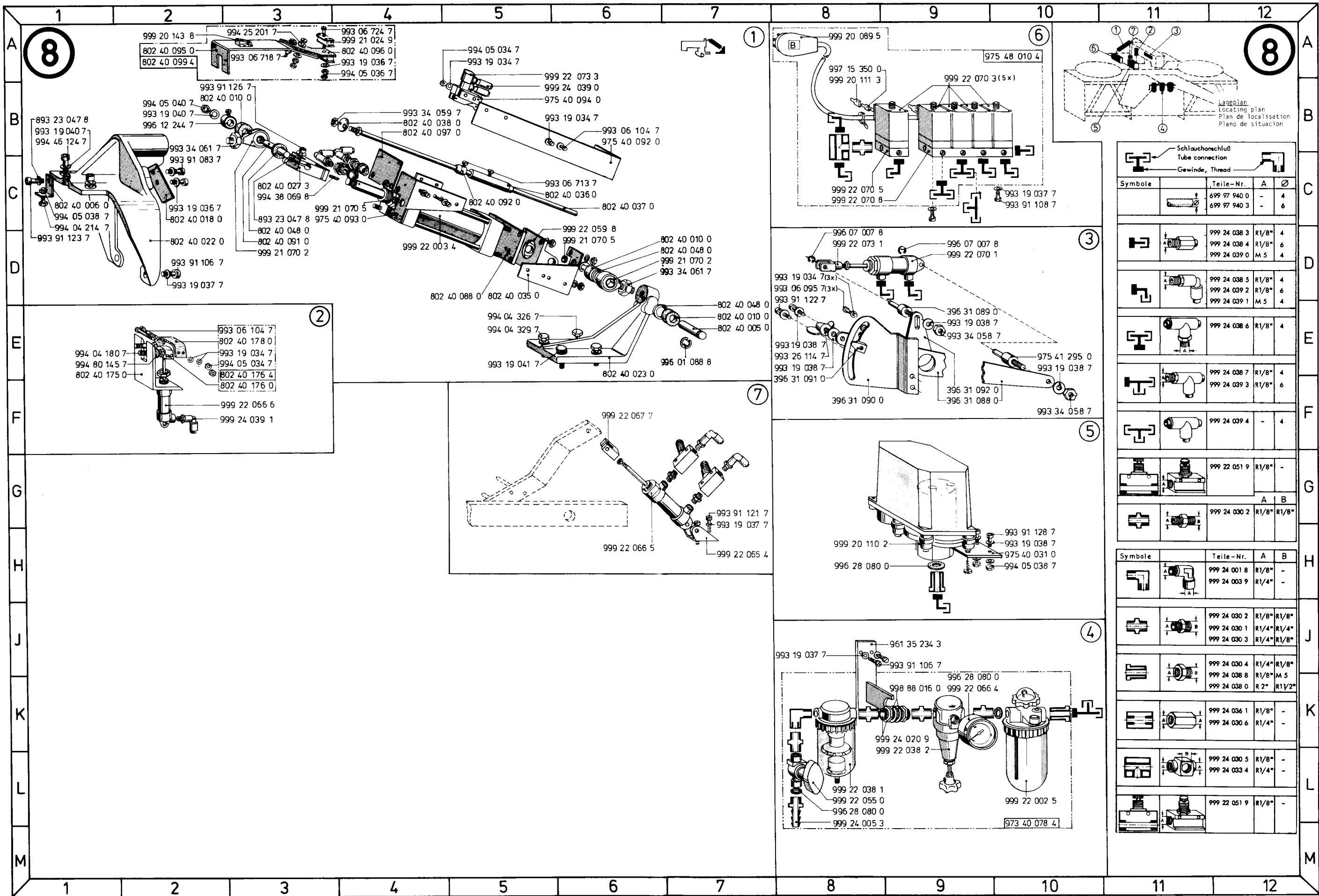

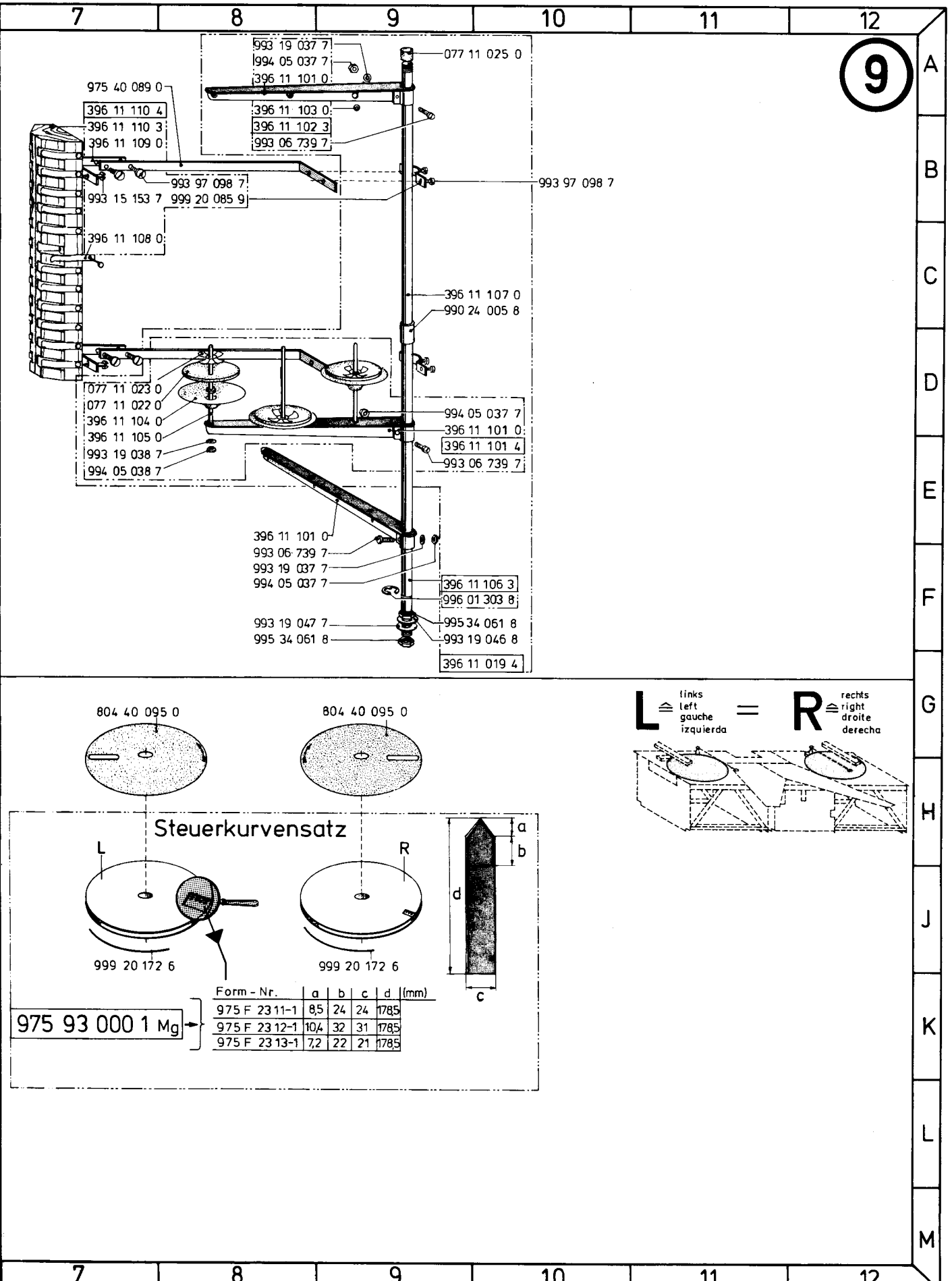
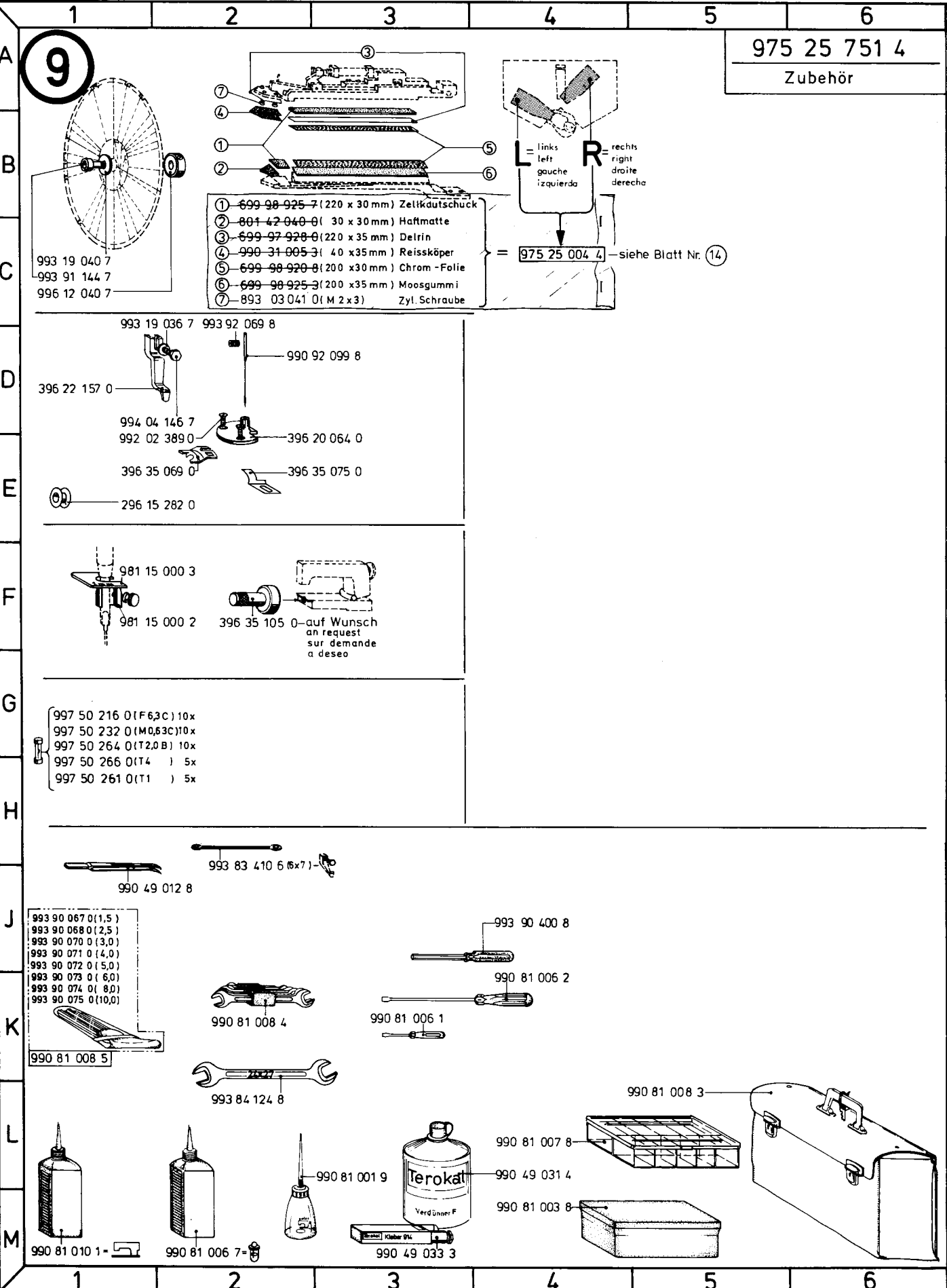

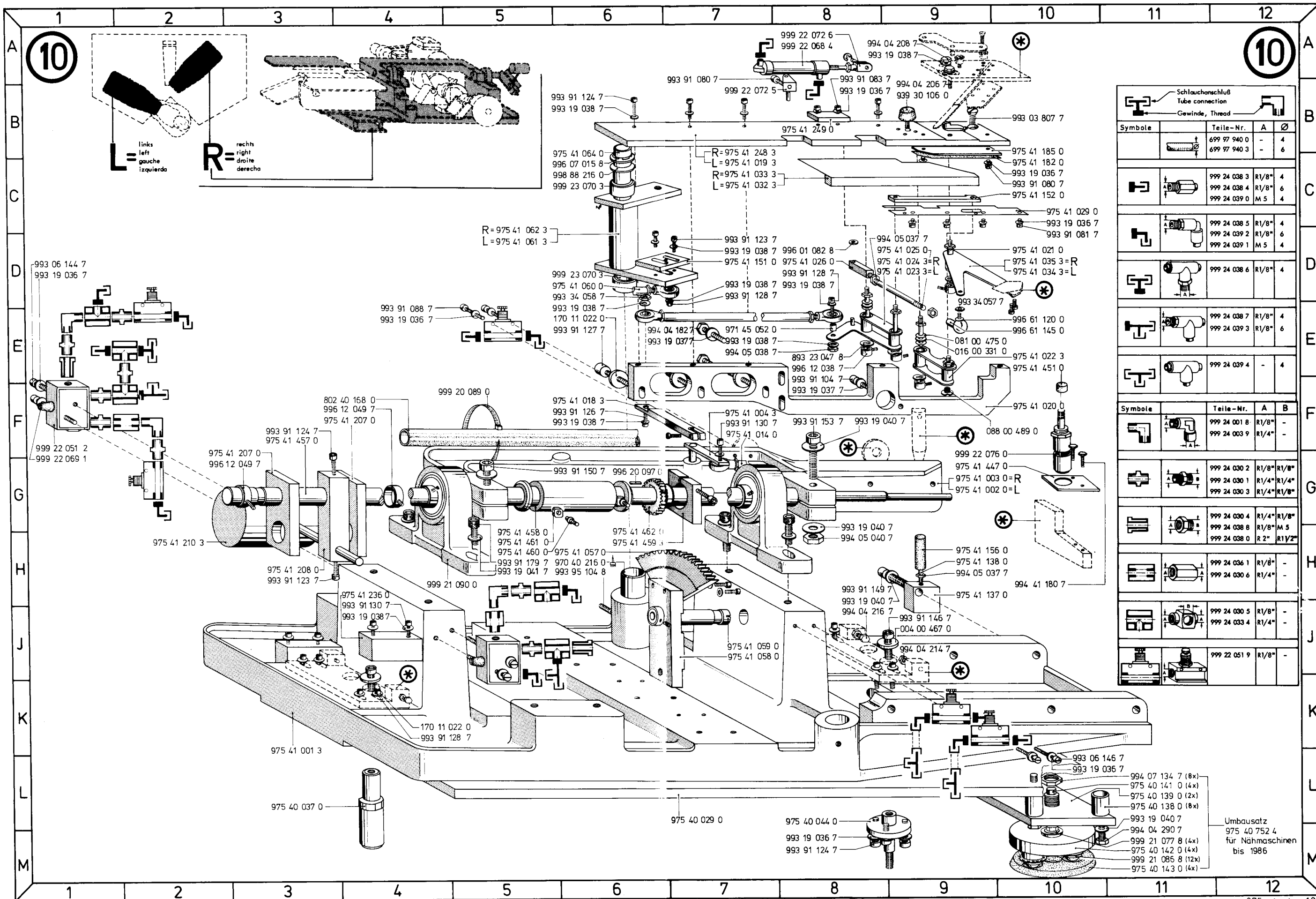

Symbol	Part No.	A	B
	699 97 940 0	-	4
	699 97 940 3	-	6
	999 24 038 3	R1/8"	4
	999 24 038 4	R1/8"	6
	999 24 039 0	M 5	4
	999 24 038 5	R1/8"	4
	999 24 039 2	R1/8"	6
	999 24 039 1	M 5	4
	999 24 038 6	R1/8"	4
	999 24 038 7	R1/8"	4
	999 24 039 3	R1/8"	6
	999 24 039 4	-	4
	999 24 039 5	-	4
	999 24 001 8	R1/8"	-
	999 24 003 9	R1/4"	-
	999 24 030 2	R1/8"	R1/8"
	999 24 030 1	R1/4"	R1/4"
	999 24 030 3	R1/4"	R1/8"
	999 24 030 4	R1/4"	R1/8"
	999 24 038 8	R1/8"	M 5
	999 24 038 0	R 2"	R1/2"
	999 24 036 1	R1/8"	-
	999 24 030 6	R1/4"	-
	999 24 030 5	R1/8"	-
	999 24 033 4	R1/4"	-
	999 22 051 9	R1/8"	-

Umbausatz  
975 40 752 4  
für Nähmaschinen  
bis 1986

994 07 134 7 (8x)
975 40 141 0 (4x)
975 40 139 0 (2x)
975 40 138 0 (8x)
993 19 040 7
994 04 290 7
999 21 077 8 (4x)
975 40 142 0 (4x)
999 21 085 8 (12x)
975 40 143 0 (4x)

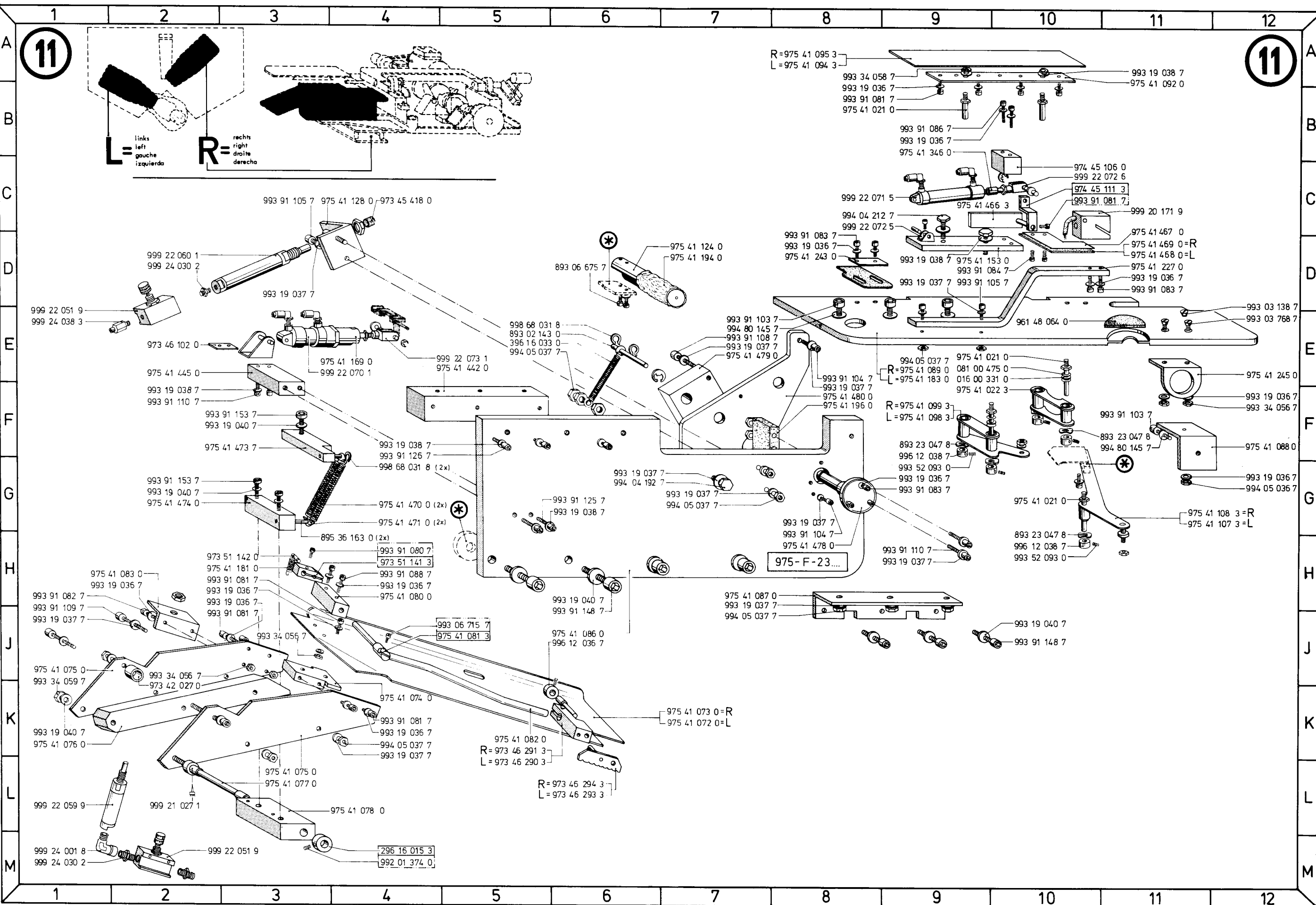

11

11

L= links  
left  
gauche  
izquierda

R= rechts  
right  
droite  
derecha

R=975 41 095 3  
L=975 41 094 3

993 34 058 7  
993 19 036 7  
993 91 081 7  
975 41 021 0

993 91 086 7  
993 19 036 7  
975 41 346 0

974 45 106 0  
999 22 072 6  
974 45 111 3  
993 91 081 7

999 22 071 5  
994 04 212 7  
999 22 072 5

999 20 171 9  
975 41 467 0  
975 41 469 0=R  
975 41 468 0=L

993 91 083 7  
993 19 036 7  
975 41 243 0

993 19 038 7  
975 41 153 0  
993 91 084 7  
993 19 037 7  
993 91 105 7

975 41 227 0  
993 19 036 7  
993 91 083 7

993 03 138 7  
993 03 768 7

994 05 037 7  
R=975 41 089 0  
L=975 41 183 0

975 41 021 0  
081 00 475 0  
016 00 331 0  
975 41 022 3

975 41 245 0  
993 19 036 7  
993 34 056 7

R=975 41 099 3  
L=975 41 098 3

993 91 103 7  
893 23 047 8  
994 80 145 7

893 23 047 8  
996 12 038 7  
993 52 093 0  
993 19 036 7  
993 91 083 7

975 41 088 0  
993 19 036 7  
994 05 036 7

975 41 021 0  
893 23 047 8  
996 12 038 7  
993 52 093 0

975 41 108 3=R  
975 41 107 3=L

975-F-23...

993 19 037 7  
993 91 104 7  
975 41 478 0

975 41 021 0  
993 19 037 7

975 41 087 0  
993 19 037 7  
994 05 037 7

993 19 040 7  
993 91 148 7

975 41 073 0=R  
975 41 072 0=L

975 41 082 0  
R=973 46 291 3  
L=973 46 290 3

R=973 46 294 3  
L=973 46 293 3

996 16 015 3  
992 01 374 0

\* Formteile siehe Bildtafel Nr.  
Pattern see diagram No.  
Pièces de forme voir tableau illustré N°  
Piezas de forma ver lámina de grabados N°

14

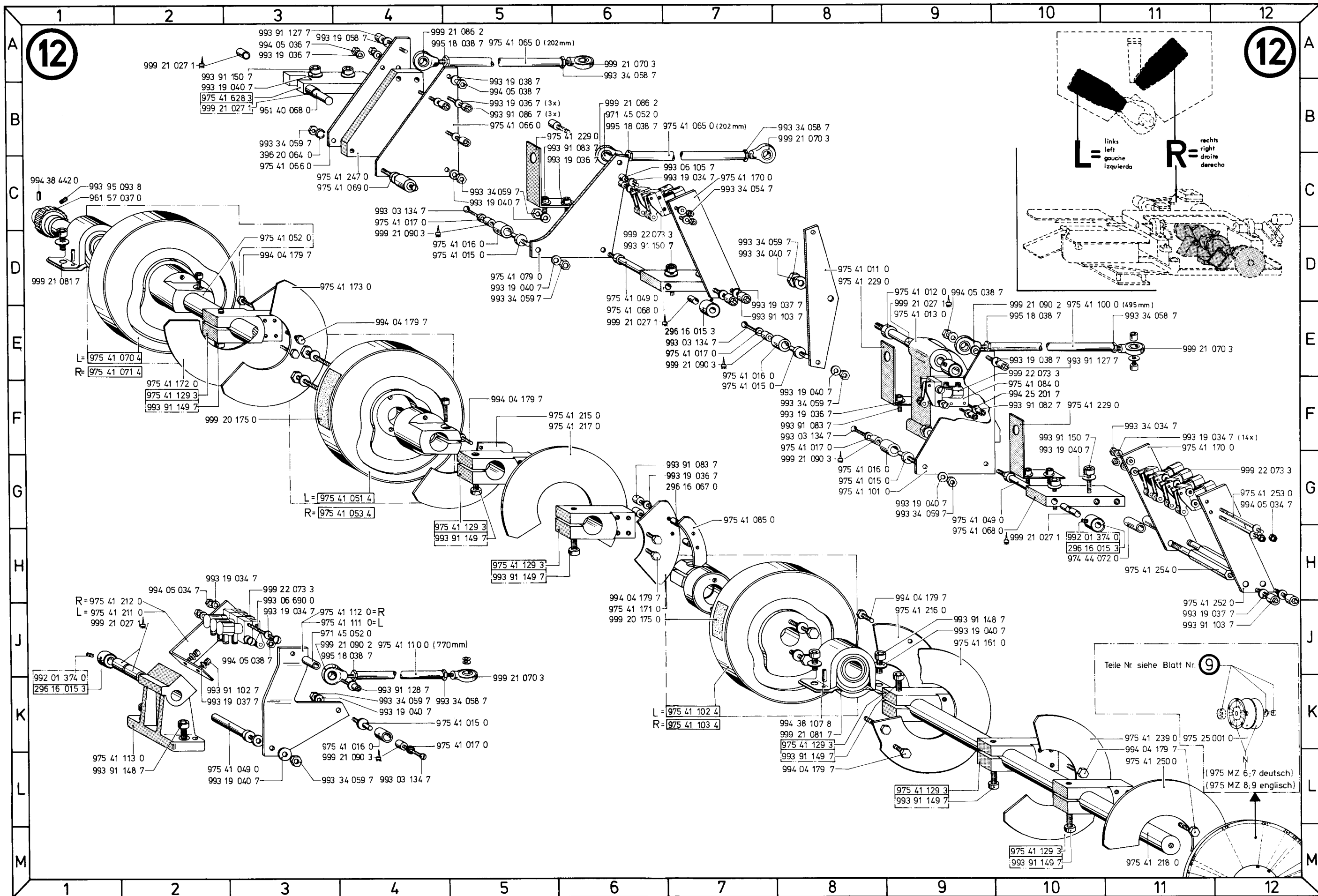

13

13

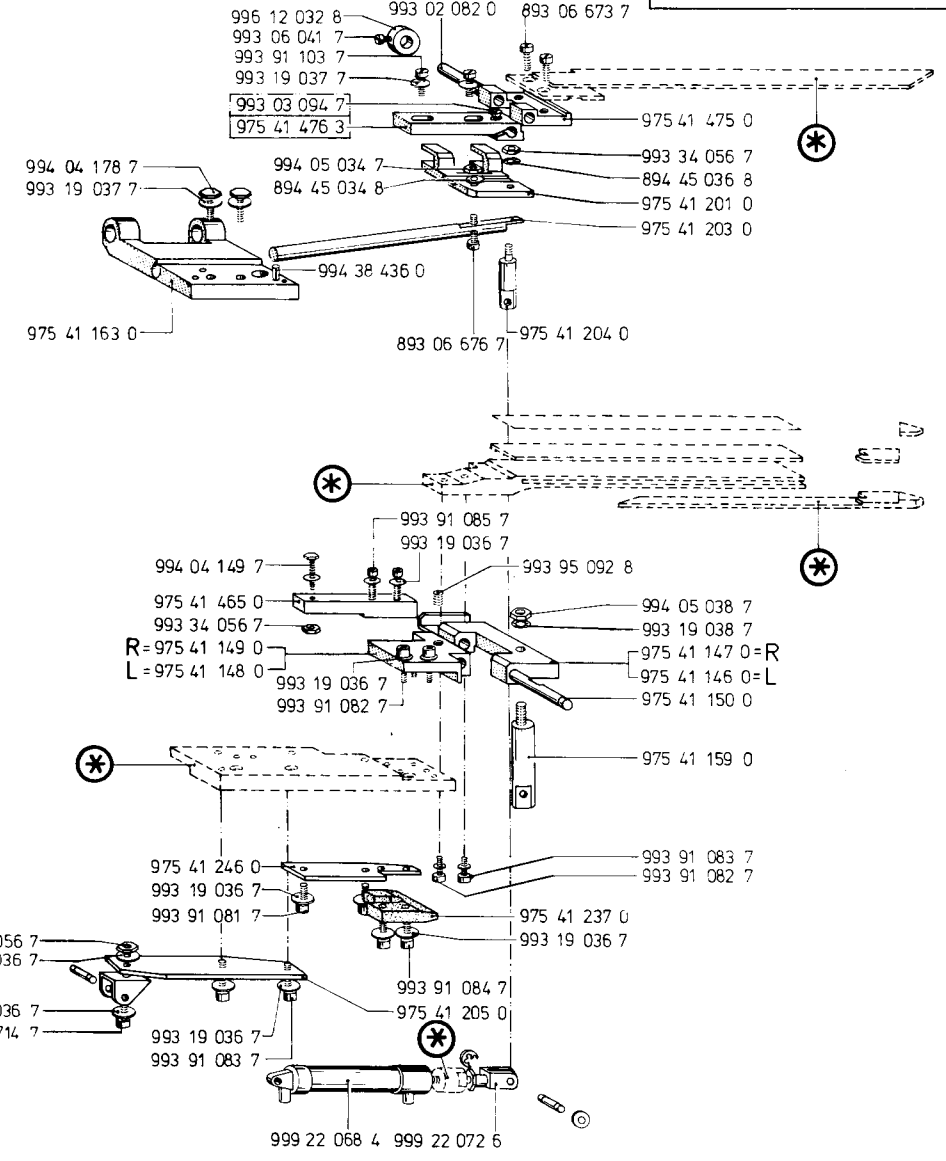
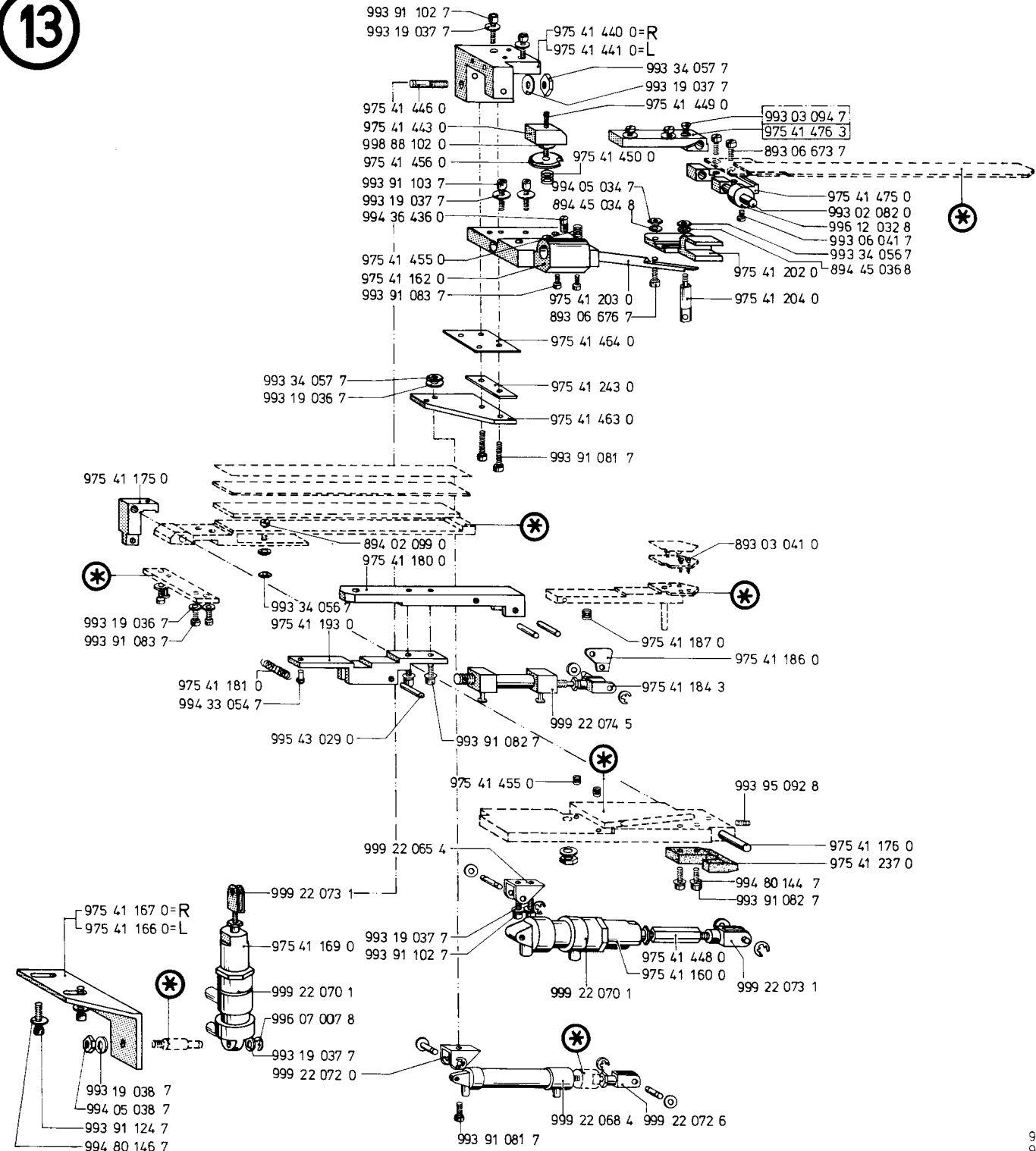
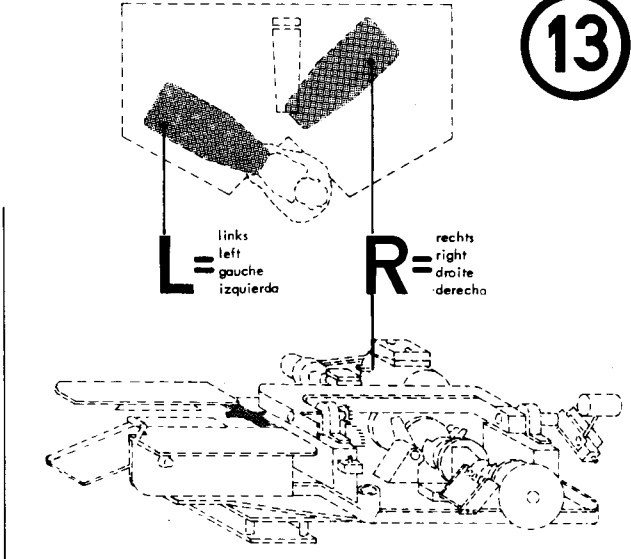

\* - Formteile siehe Bildtafel Nr.  
Pattern see diagram No.  
Pièces de forme voir tableau illustré N°  
Piezas de forma ver lámina de grabados N°

14

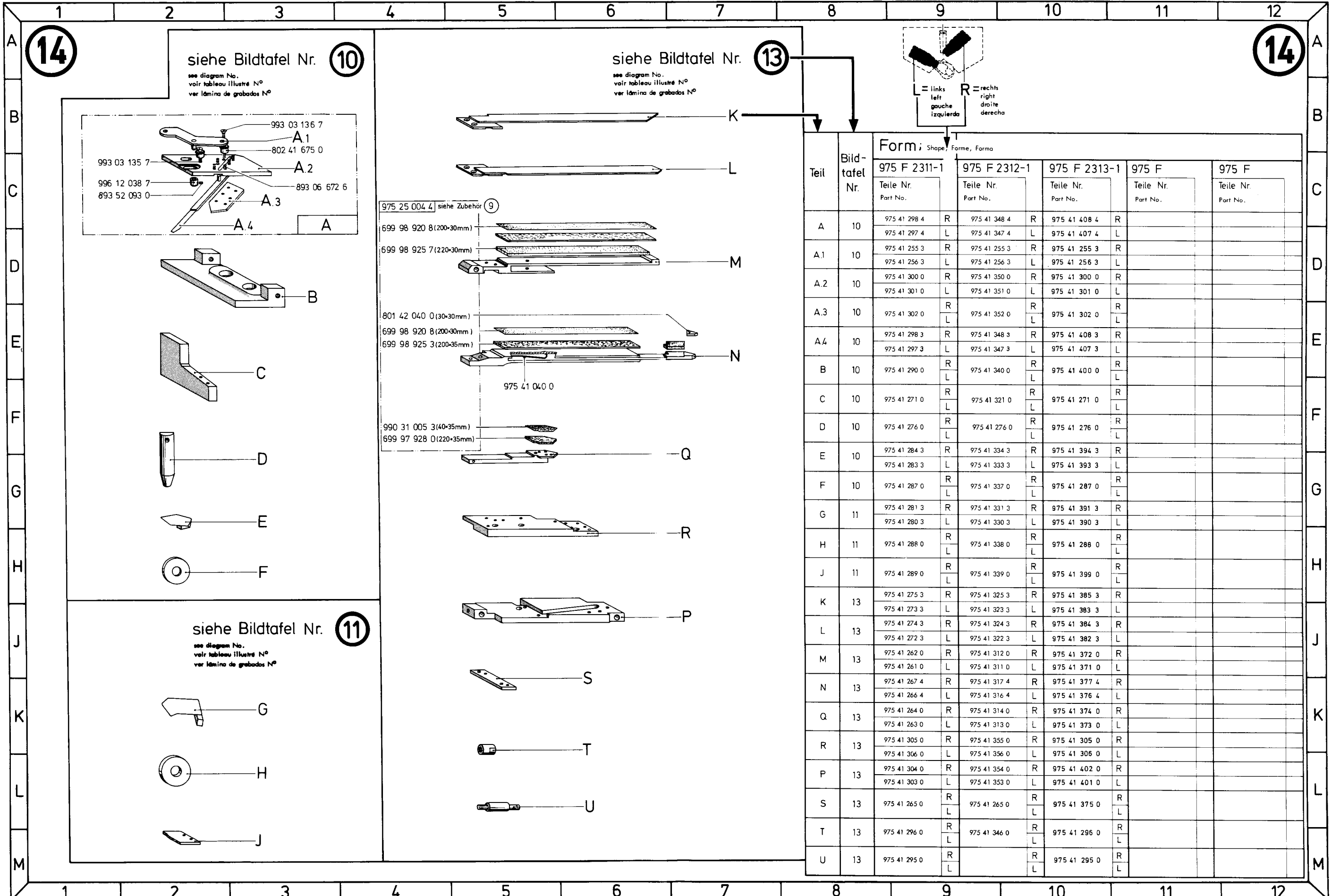

14

siehe Bildtafel Nr. 10  
see diagram No.  
voir tableau illustré N°  
ver lámina de grabados N°

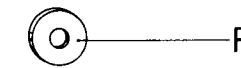
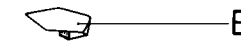
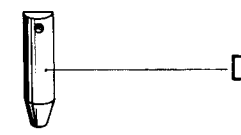
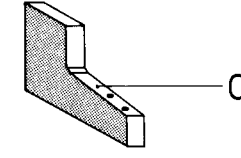
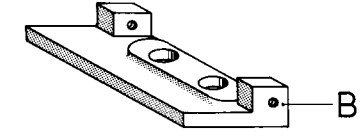
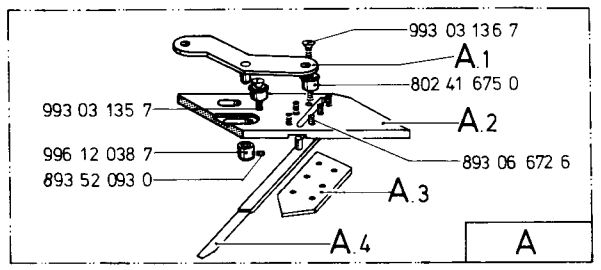

siehe Bildtafel Nr. 11  
see diagram No.  
voir tableau illustré N°  
ver lámina de grabados N°

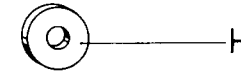
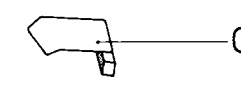

siehe Bildtafel Nr. 13  
see diagram No.  
voir tableau illustré N°  
ver lámina de grabados N°

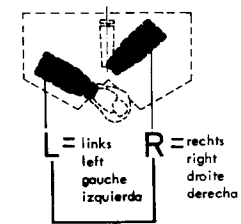
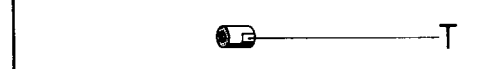
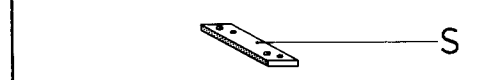
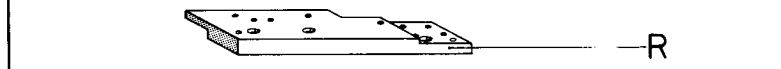
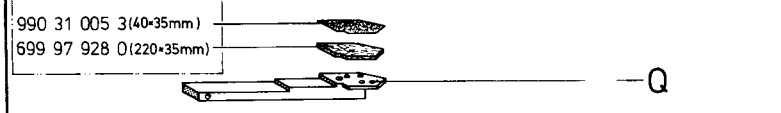
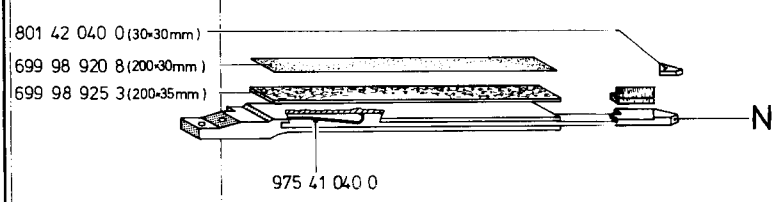
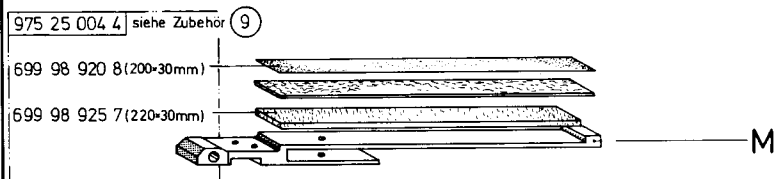
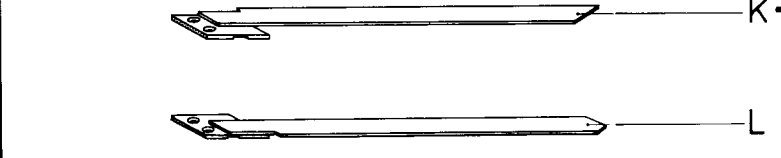

Teil	Bildtafel Nr.	Form: Shape, Forme, Forma				
		975 F 2311-1	975 F 2312-1	975 F 2313-1	975 F	975 F
		Teile Nr. Part No.	Teile Nr. Part No.	Teile Nr. Part No.	Teile Nr. Part No.	Teile Nr. Part No.
A	10	975 41 298 4 R	975 41 348 4 R	975 41 408 4 R		
		975 41 297 4 L	975 41 347 4 L	975 41 407 4 L		
A.1	10	975 41 255 3 R	975 41 255 3 R	975 41 255 3 R		
		975 41 256 3 L	975 41 256 3 L	975 41 256 3 L		
A.2	10	975 41 300 0 R	975 41 350 0 R	975 41 300 0 R		
		975 41 301 0 L	975 41 351 0 L	975 41 301 0 L		
A.3	10	975 41 302 0 R	975 41 352 0 R	975 41 302 0 R		
		975 41 302 0 L	975 41 352 0 L	975 41 302 0 L		
A.4	10	975 41 298 3 R	975 41 348 3 R	975 41 408 3 R		
		975 41 297 3 L	975 41 347 3 L	975 41 407 3 L		
B	10	975 41 290 0 R	975 41 340 0 R	975 41 400 0 R		
		975 41 290 0 L	975 41 340 0 L	975 41 400 0 L		
C	10	975 41 271 0 R	975 41 321 0 R	975 41 271 0 R		
		975 41 271 0 L	975 41 321 0 L	975 41 271 0 L		
D	10	975 41 276 0 R	975 41 276 0 R	975 41 276 0 R		
		975 41 276 0 L	975 41 276 0 L	975 41 276 0 L		
E	10	975 41 284 3 R	975 41 334 3 R	975 41 394 3 R		
		975 41 283 3 L	975 41 333 3 L	975 41 393 3 L		
F	10	975 41 287 0 R	975 41 337 0 R	975 41 287 0 R		
		975 41 287 0 L	975 41 337 0 L	975 41 287 0 L		
G	11	975 41 281 3 R	975 41 331 3 R	975 41 391 3 R		
		975 41 280 3 L	975 41 330 3 L	975 41 390 3 L		
H	11	975 41 288 0 R	975 41 338 0 R	975 41 288 0 R		
		975 41 288 0 L	975 41 338 0 L	975 41 288 0 L		
J	11	975 41 289 0 R	975 41 339 0 R	975 41 399 0 R		
		975 41 289 0 L	975 41 339 0 L	975 41 399 0 L		
K	13	975 41 275 3 R	975 41 325 3 R	975 41 385 3 R		
		975 41 273 3 L	975 41 323 3 L	975 41 383 3 L		
L	13	975 41 274 3 R	975 41 324 3 R	975 41 384 3 R		
		975 41 272 3 L	975 41 322 3 L	975 41 382 3 L		
M	13	975 41 262 0 R	975 41 312 0 R	975 41 372 0 R		
		975 41 261 0 L	975 41 311 0 L	975 41 371 0 L		
N	13	975 41 267 4 R	975 41 317 4 R	975 41 377 4 R		
		975 41 266 4 L	975 41 316 4 L	975 41 376 4 L		
Q	13	975 41 264 0 R	975 41 314 0 R	975 41 374 0 R		
		975 41 263 0 L	975 41 313 0 L	975 41 373 0 L		
R	13	975 41 305 0 R	975 41 355 0 R	975 41 305 0 R		
		975 41 306 0 L	975 41 356 0 L	975 41 306 0 L		
P	13	975 41 304 0 R	975 41 354 0 R	975 41 402 0 R		
		975 41 303 0 L	975 41 353 0 L	975 41 401 0 L		
S	13	975 41 265 0 R	975 41 265 0 R	975 41 375 0 R		
		975 41 265 0 L	975 41 265 0 L	975 41 375 0 L		
T	13	975 41 296 0 R	975 41 346 0 R	975 41 296 0 R		
		975 41 296 0 L	975 41 346 0 L	975 41 296 0 L		
U	13	975 41 295 0 R		975 41 295 0 R		
		975 41 295 0 L		975 41 295 0 L		



15

Pick-up 3-1  
550 51 752 4

15

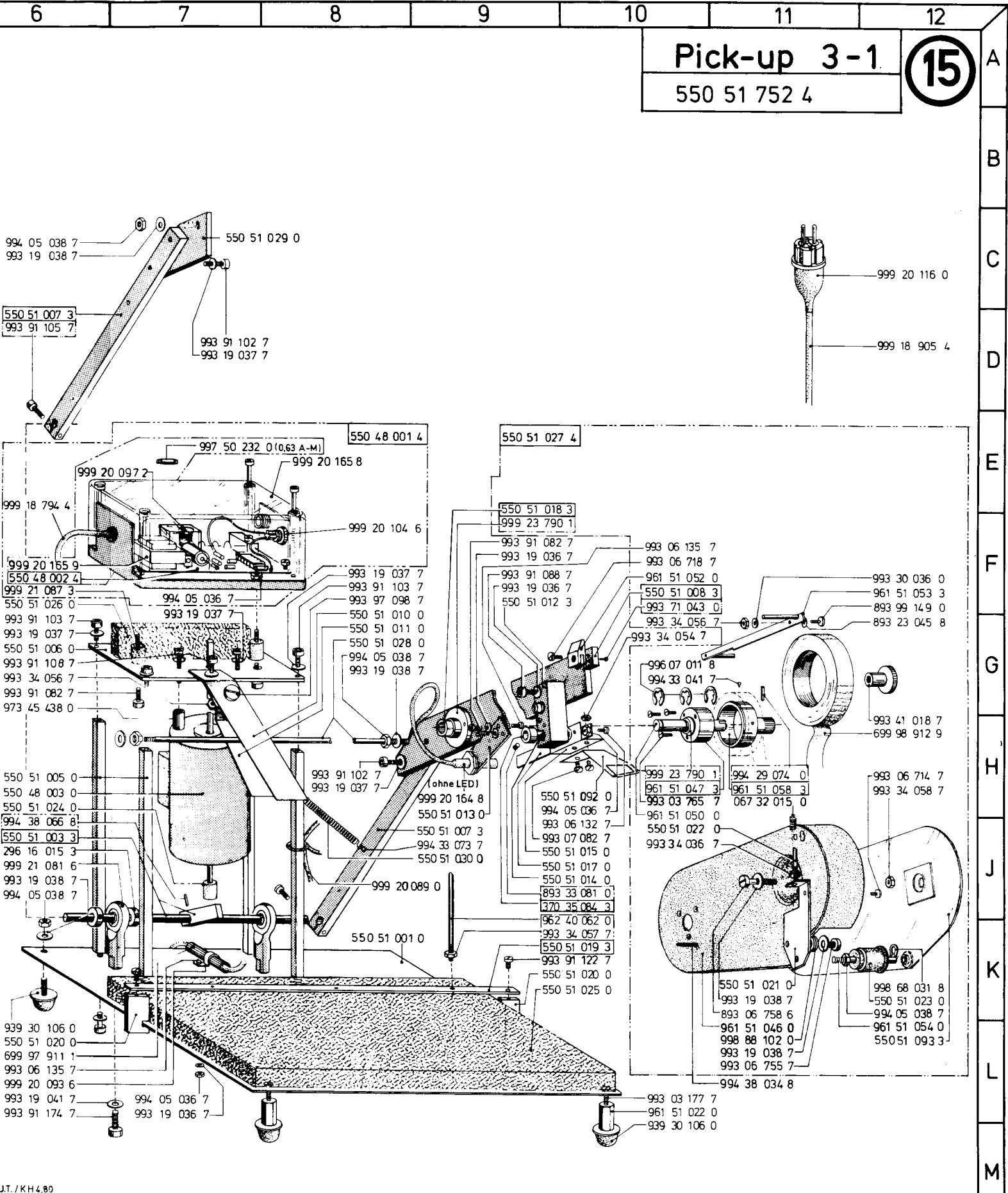
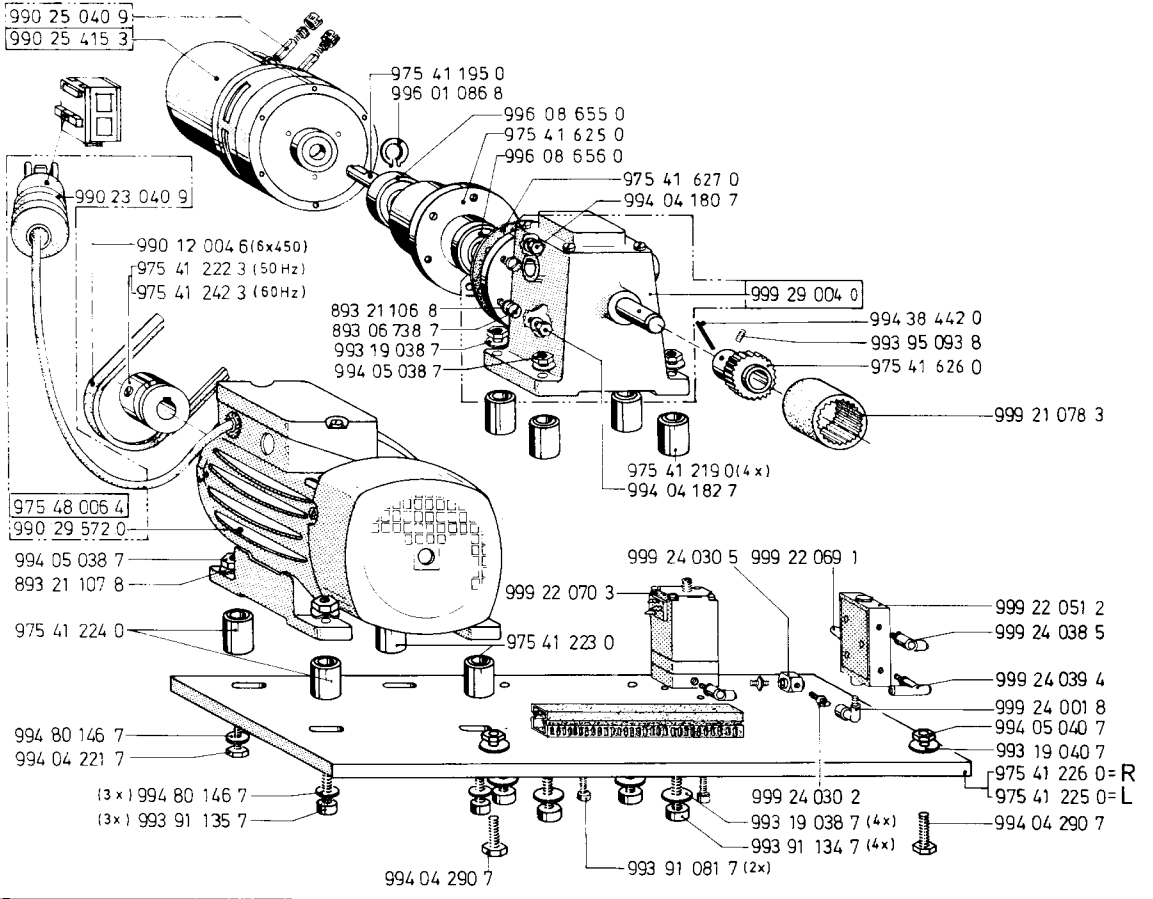
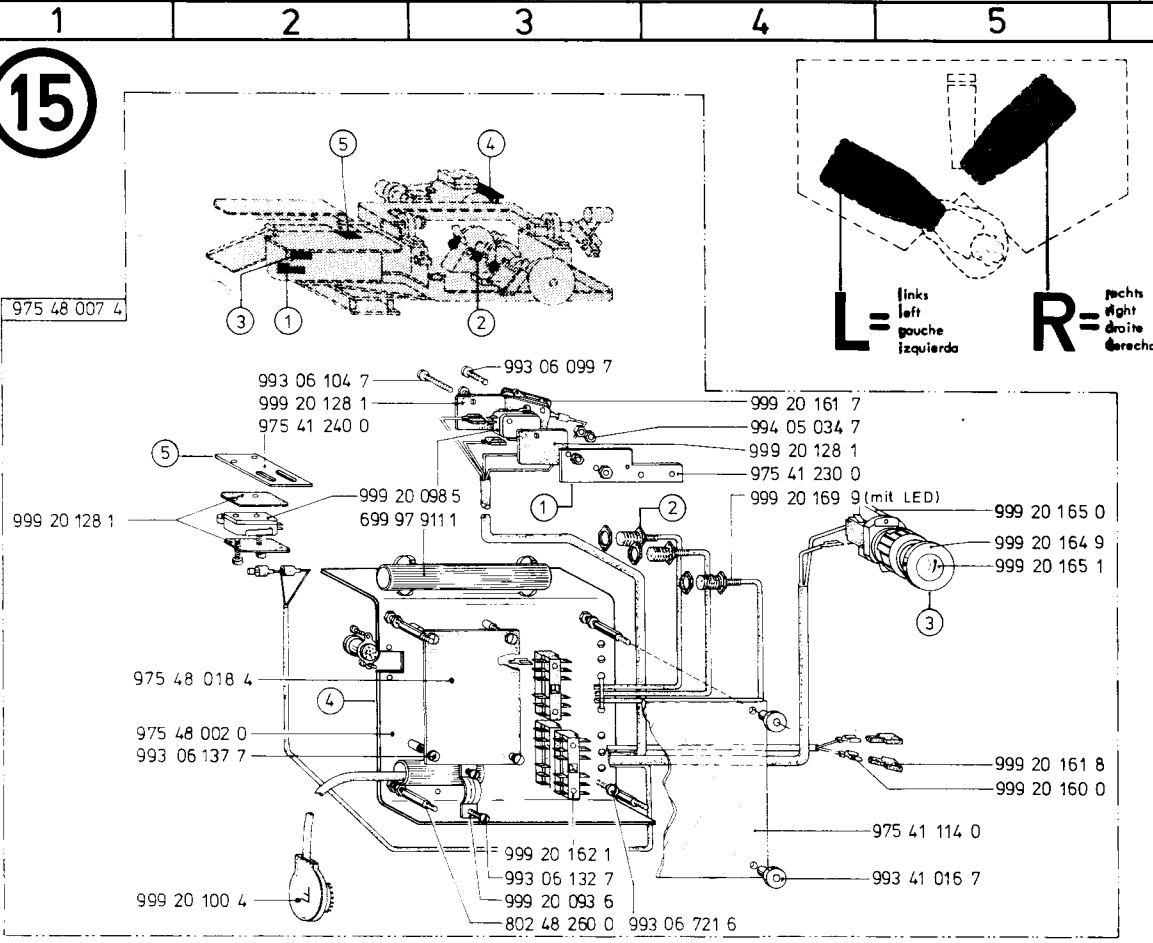

JT./KH4.80









