



Teileliste und Näheinrichtungen  
Spare Parts List and Sewing Equipment

971 · 972

DÜRKOPP ADLER AG



# Teileliste und Näheinrichtungen Spare Parts List and Sewing Equipment

## 971 · 972



Zusatzaggregate:  
Complementary equipment:  
Equipment supplémentaire:  
Aparatos especiales:

Nähguthalter  
Sewing fabric holder  
Porte-pince  
Sujeta material

Stapler  
Stacker  
Empileur  
Apilador

Kettfadentrenner  
Chain thread cutter  
Coupeur de chainette  
Separador del hilo de cadeneta

Einschneideinrichtung: nur für Kl. 972-210  
Incising unit: (972-210)  
Dispositif de coupage: (seulement pour Cl. 972-210)  
Dispositivo para hacer incisiones: (solo para modelo 972-210)

**971** Automat mit Doppelkettenstich-Nähkopf,  
Stichtyp 401 (ohne Eckenstich) min r = 3,5 mm  
Automatic with double chain stitch-sewing head  
stitch type 401 (without corner stitch) min. r = 3,5 mm  
Automate avec tête de piquage pour double point de chainette  
Type de point 401 (sans point angulaire) r. min 3,5 mm  
Automata con cabezal de coser de punto doble de cadeneta  
tipo de puntada 401 (sin puntada en la esquina) r. min. = 3,5 mm

**972** Automat mit Doppelstepstich-Nähkopf,  
Stichtyp 301 (Eckenstich)  
Automatic with double lockstitch-sewing head  
stitch type 301 (with corner stitch)  
Automate avec tête de piquage pour double point de couture  
Type de point 301 (avec point angulaire)  
Automata con cabezal de coser de doble respunte  
Tipo de puntada 301 (con puntada en la esquina)

Unterklassenschlüssel:  
Subclass key:  
Designation des sous-classes:  
Clasificación de las subclases y su clave:

Hauptklasse:  
Main class:  
Classe principale:  
Modelo base:

Beschneider: ohne = 2  
mit = 8  
Trimmer: without = 2  
with = 8  
Dispositif de coupe: sans = 2  
avec = 8  
Cabezal recortador: sin = 2  
con = 8

Nähguthalter: starr = 0  
verstellbar 4er Tlg. = 1  
verstellbar 6er Tlg. = 2

Sewing fabric holder: rigid = 0  
adjustable in 4 parts = 1  
adjustable in 6 parts = 2

Porte-matière à coudre: fix = 0  
réglable à 4 pièces = 1  
réglable à 6 pièces = 2

Sujetamaterial: fijo = 0  
regulable de 4 puestos = 1  
regulable de 6 puestos = 2

Erweiterungsstelle: nicht belegt = 0  
für Krawatten = 1  
für Handschuhe = 3

Expanding position: free = 0  
for ties = 1  
for gloves = 3

Expension: libre = 0  
pour chravattes = 1  
pour guants = 3

Renglor indicando: libro = 0  
corbatas = 1  
guantes = 3

Elektrische Ausführung:  
Electrical equipment:  
Execution électrique:  
Equipo electrico:

3x380 V, 50 Hz + N (Mp) = 1  
3x220 V, 50 Hz = 2  
3x220 V, 60 Hz = 3  
3x415 V, 50 Hz + N (Mn) = 4

Reihenfolge und Aufteilung der Bildtafeln  
 Sequence and breakdown of the illustrations  
 Suite et division des illustrations

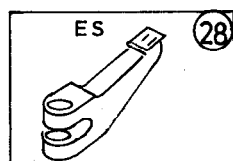
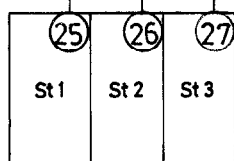
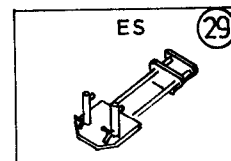
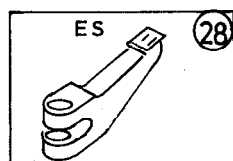
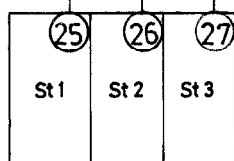
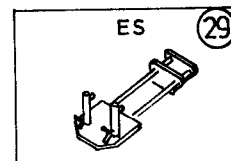
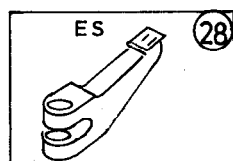
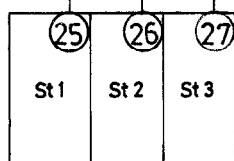
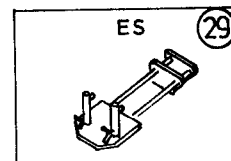
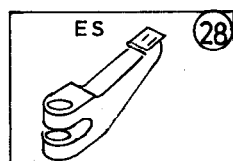
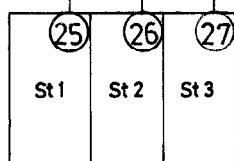
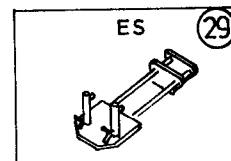
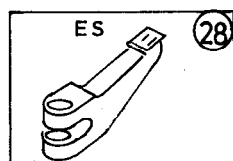
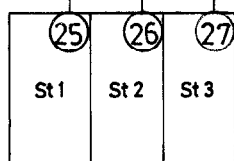
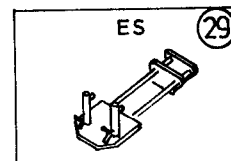
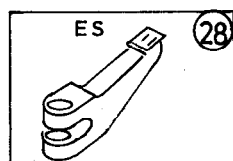
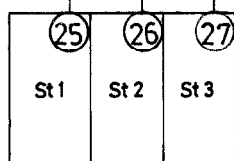
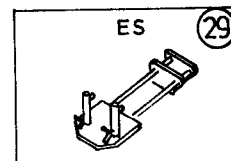
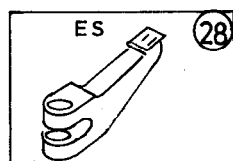
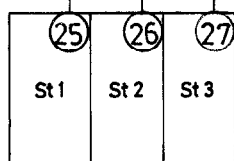
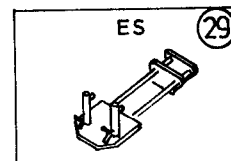
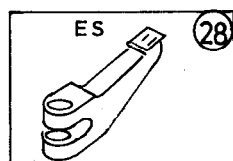
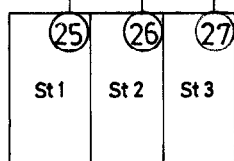
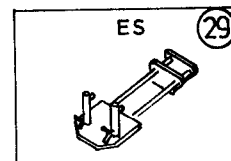
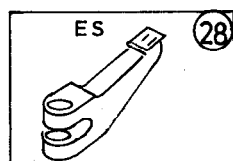
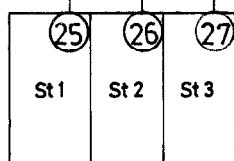
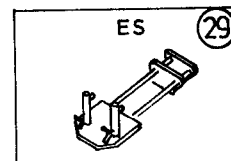
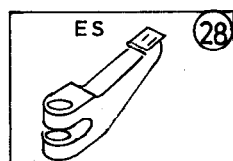
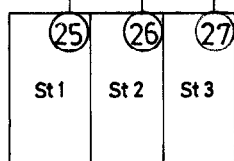
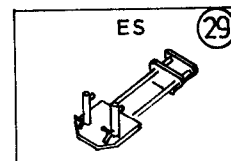
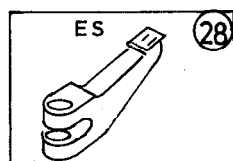
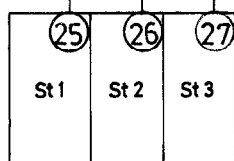
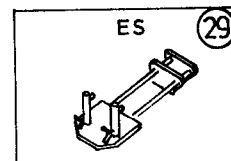
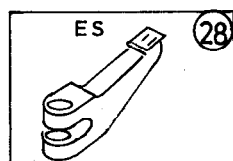
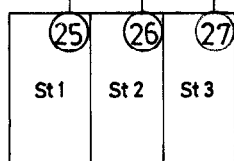
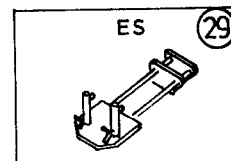
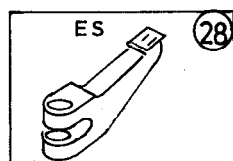
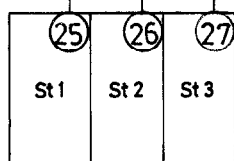
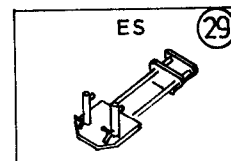
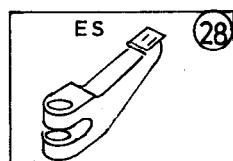
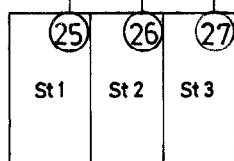
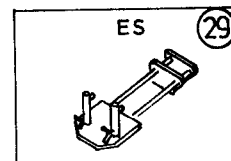
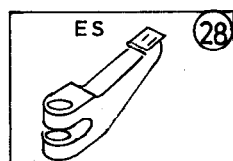
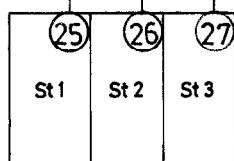
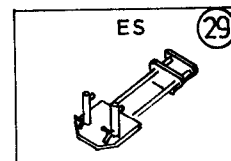
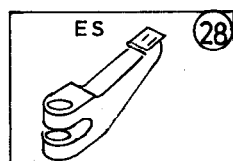
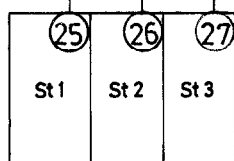
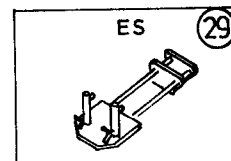
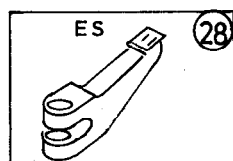
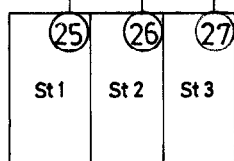
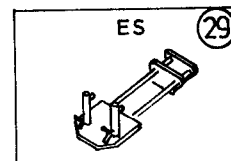
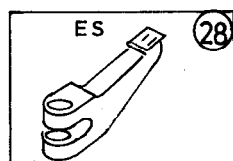
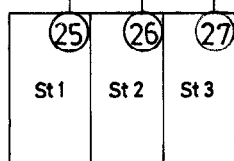
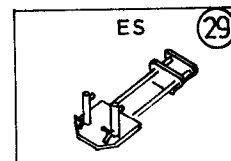
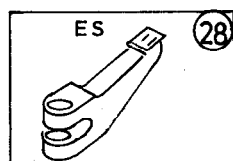
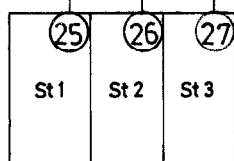
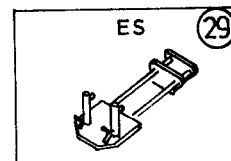
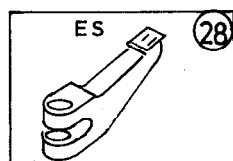
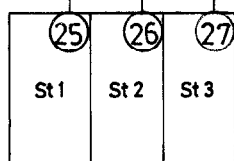
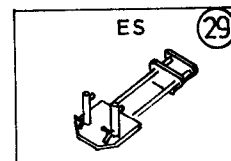
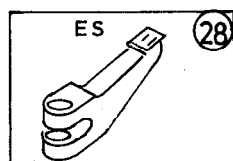
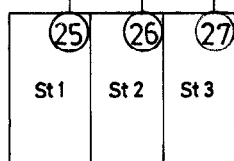
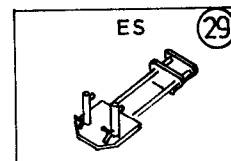
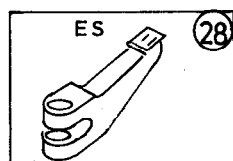
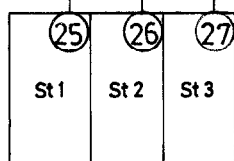
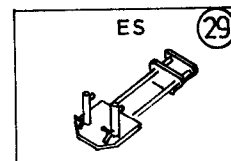
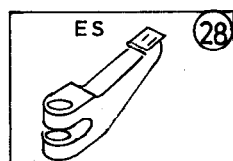
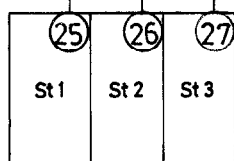
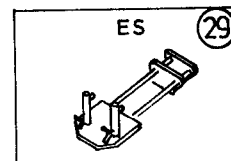
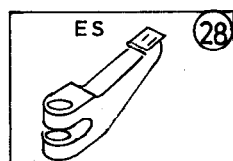
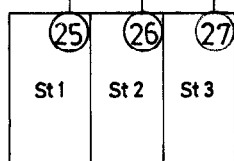
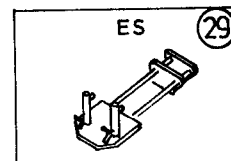
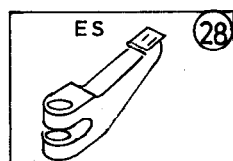
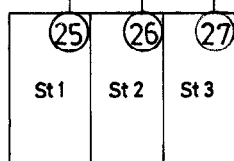
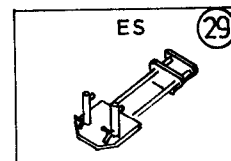
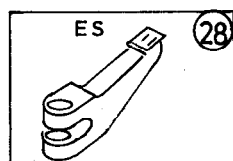
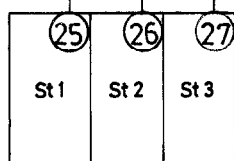
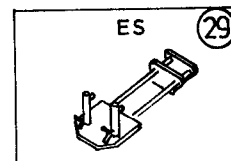
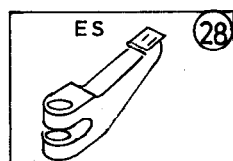
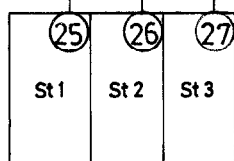
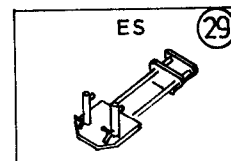
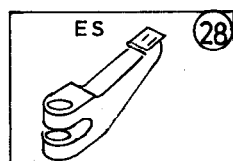
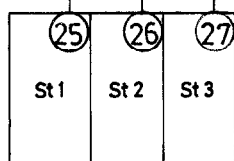
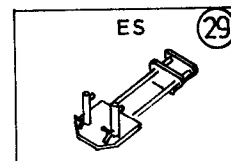
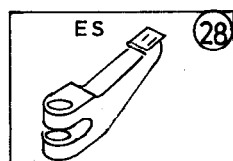
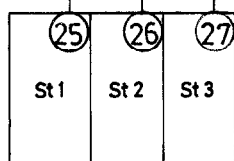
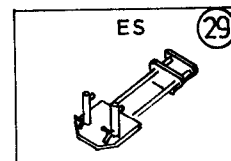
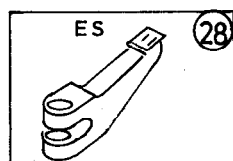
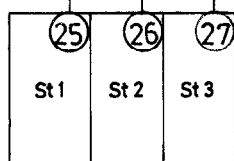
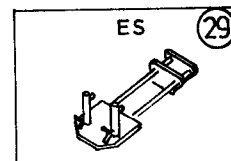
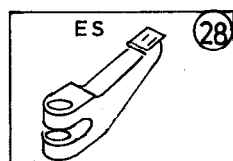
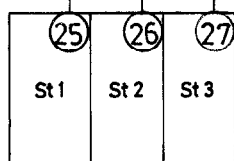
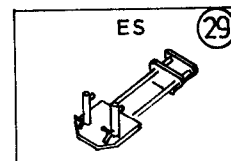
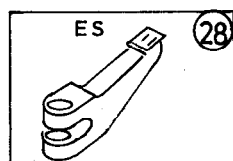
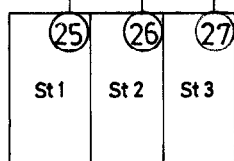
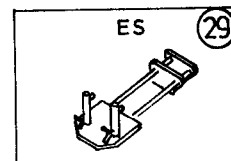
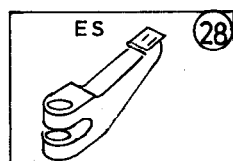
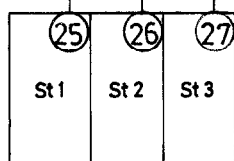
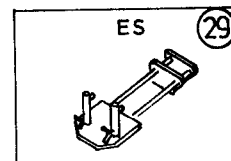
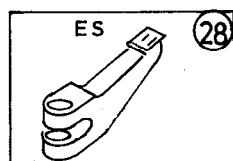
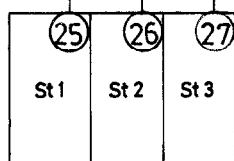
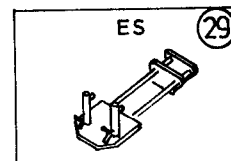
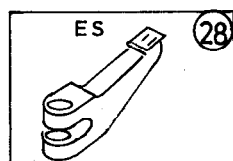
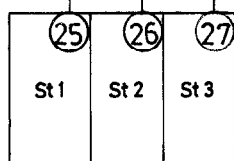
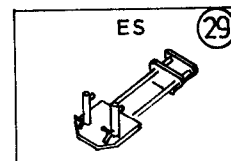
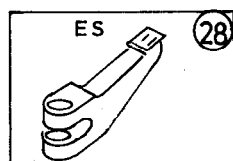
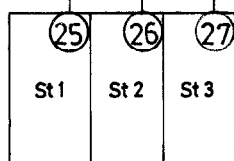
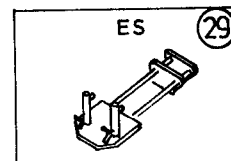
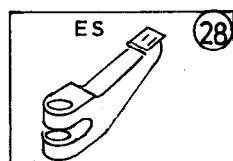
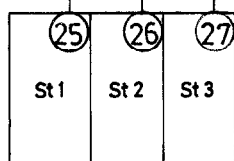
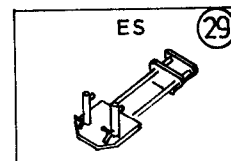
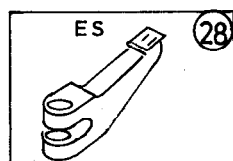
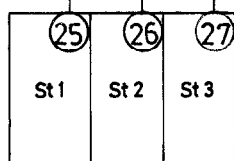
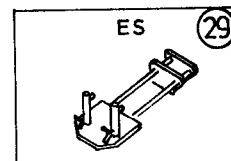
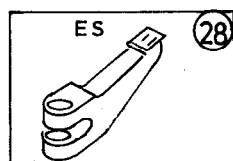
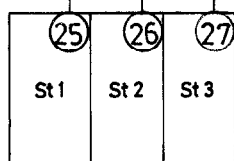
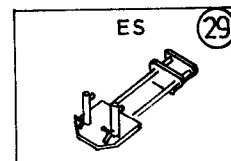
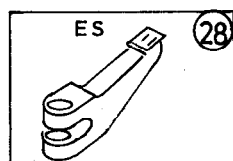
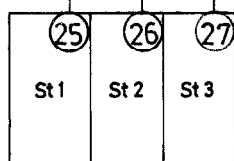
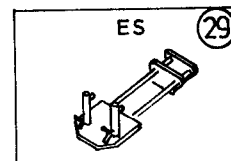
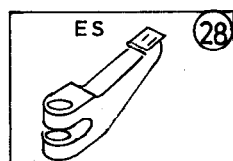
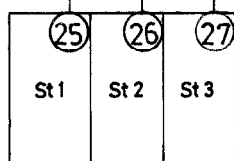
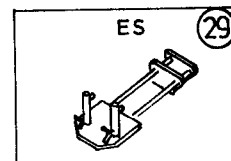
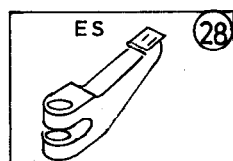
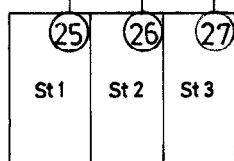
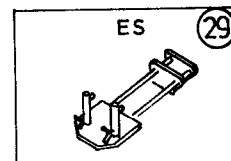
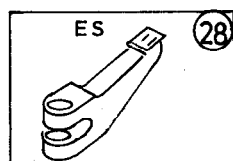
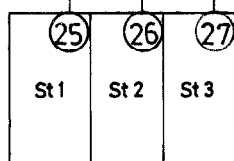
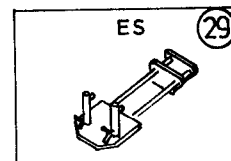
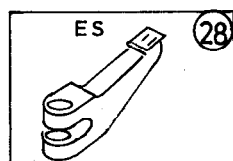
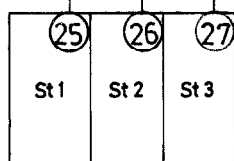
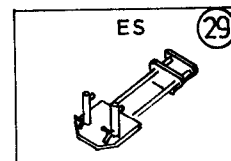
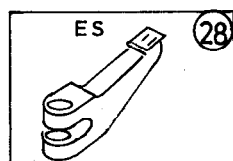
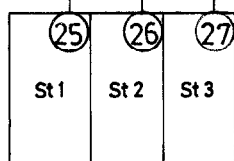
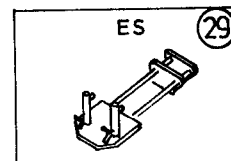
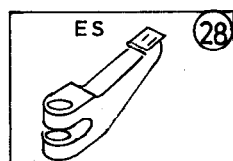
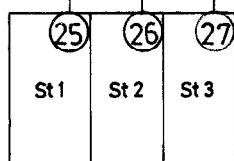
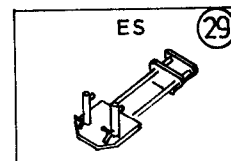
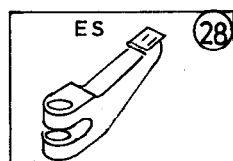
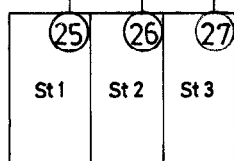
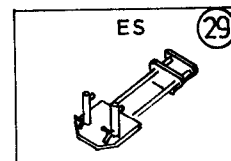
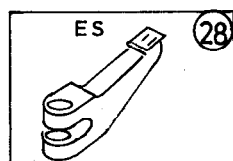
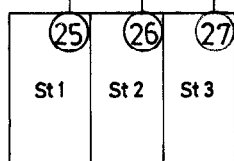
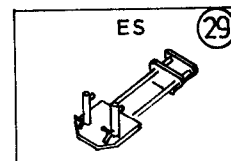
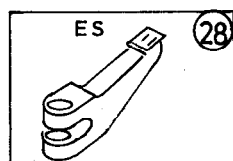
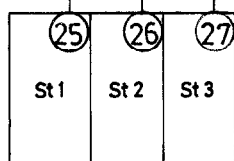
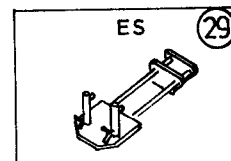
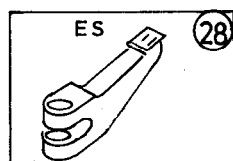
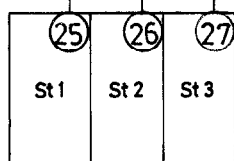
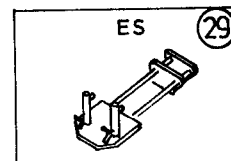
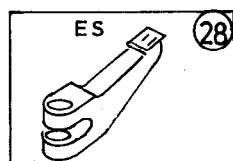
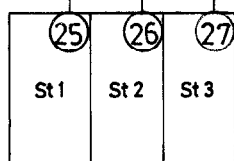
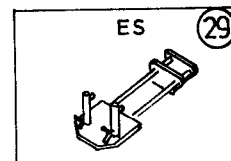
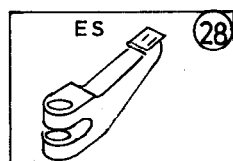
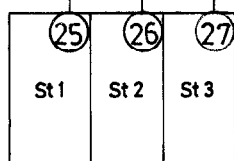
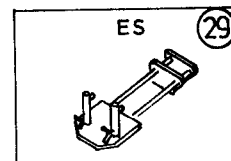
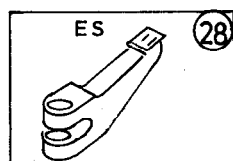
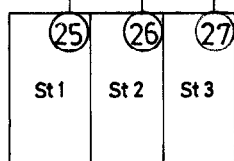
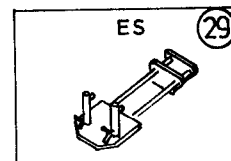
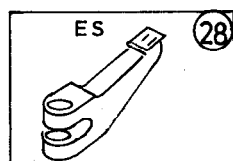
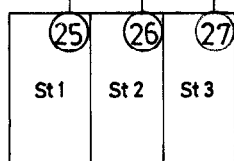
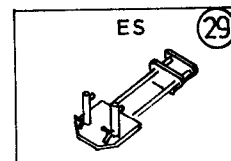
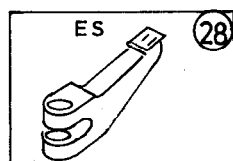
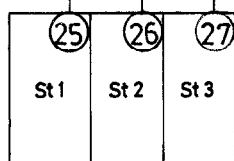
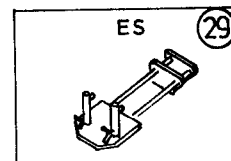
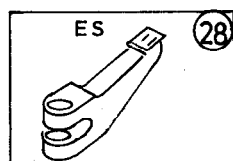
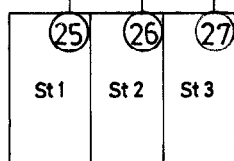
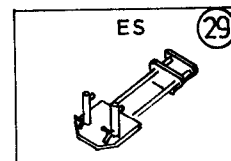
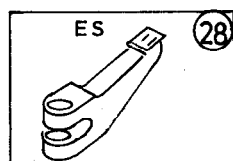
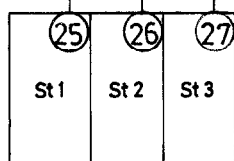
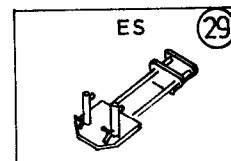
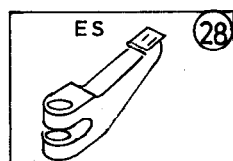
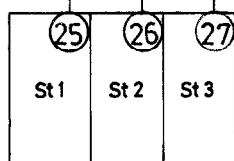
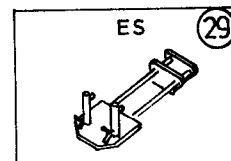
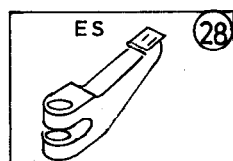
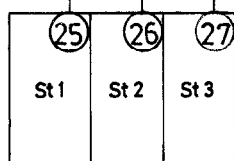
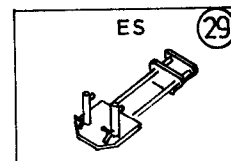
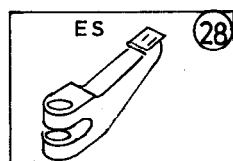
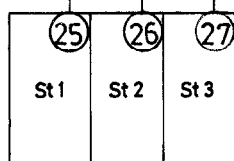
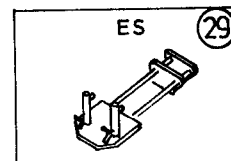
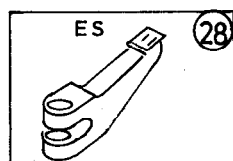
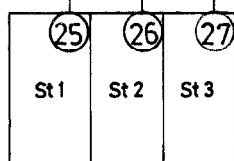
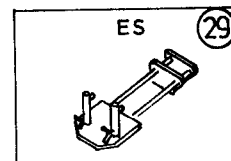
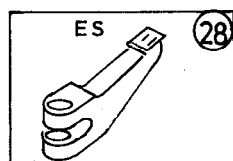
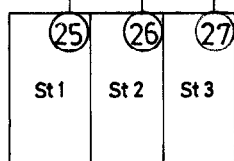
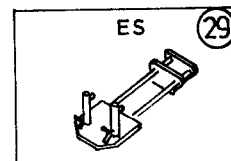
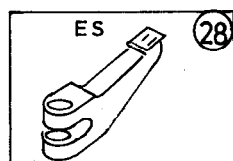
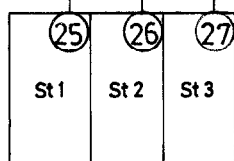
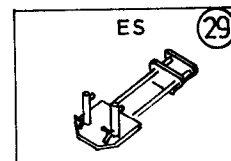
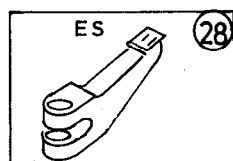
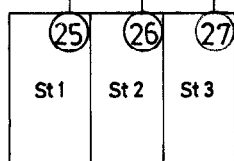
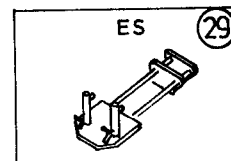
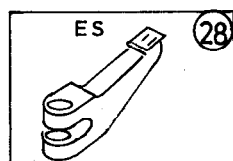
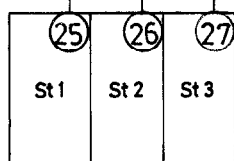
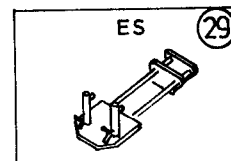
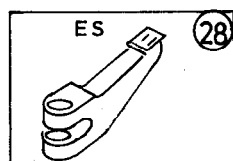
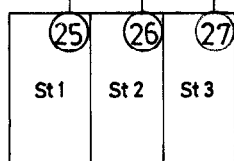
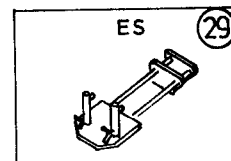
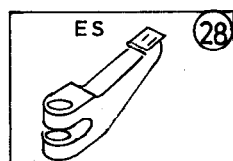
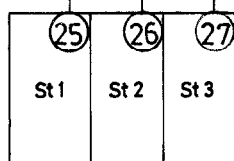
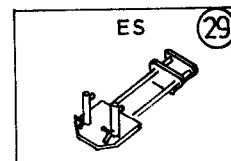
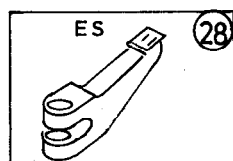
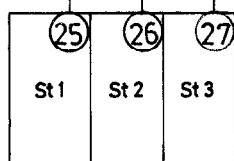
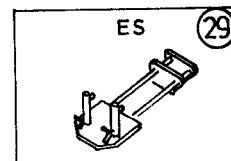
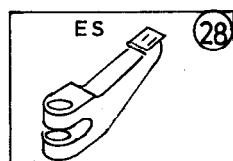
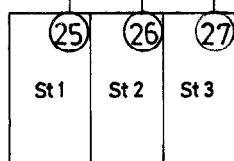
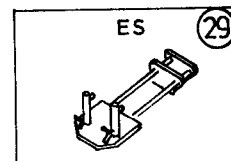
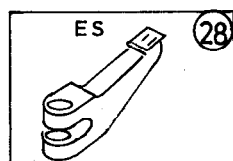
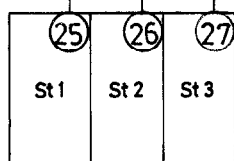
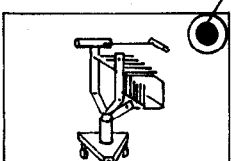
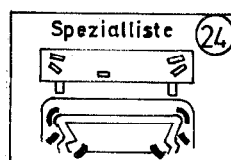
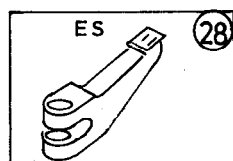
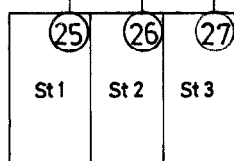
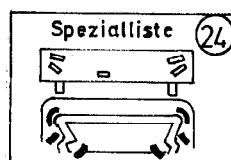
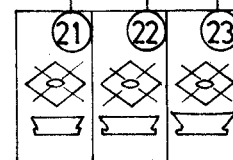
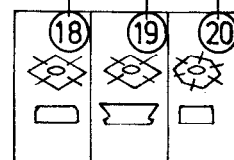
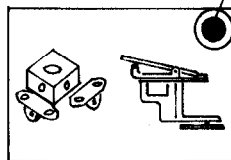
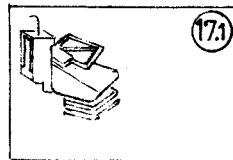
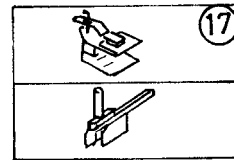
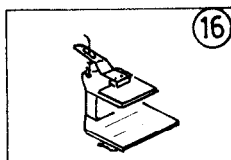
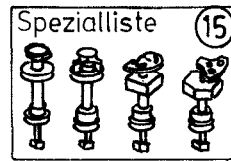
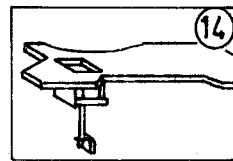
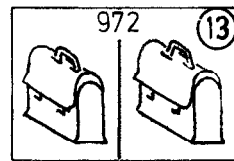
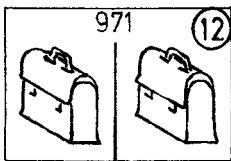
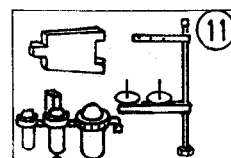
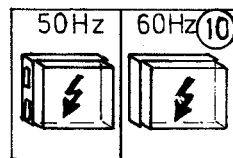
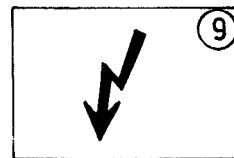
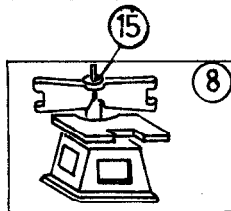
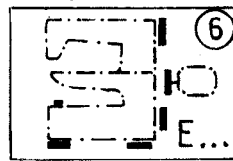
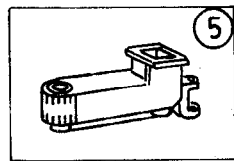
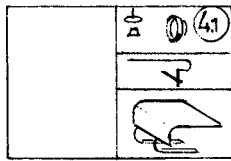
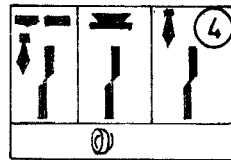
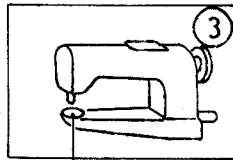
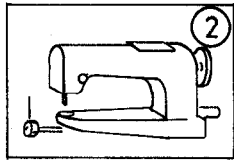
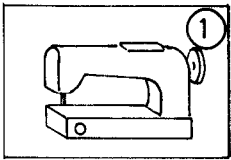







971, 972  
Beschneider

3

3

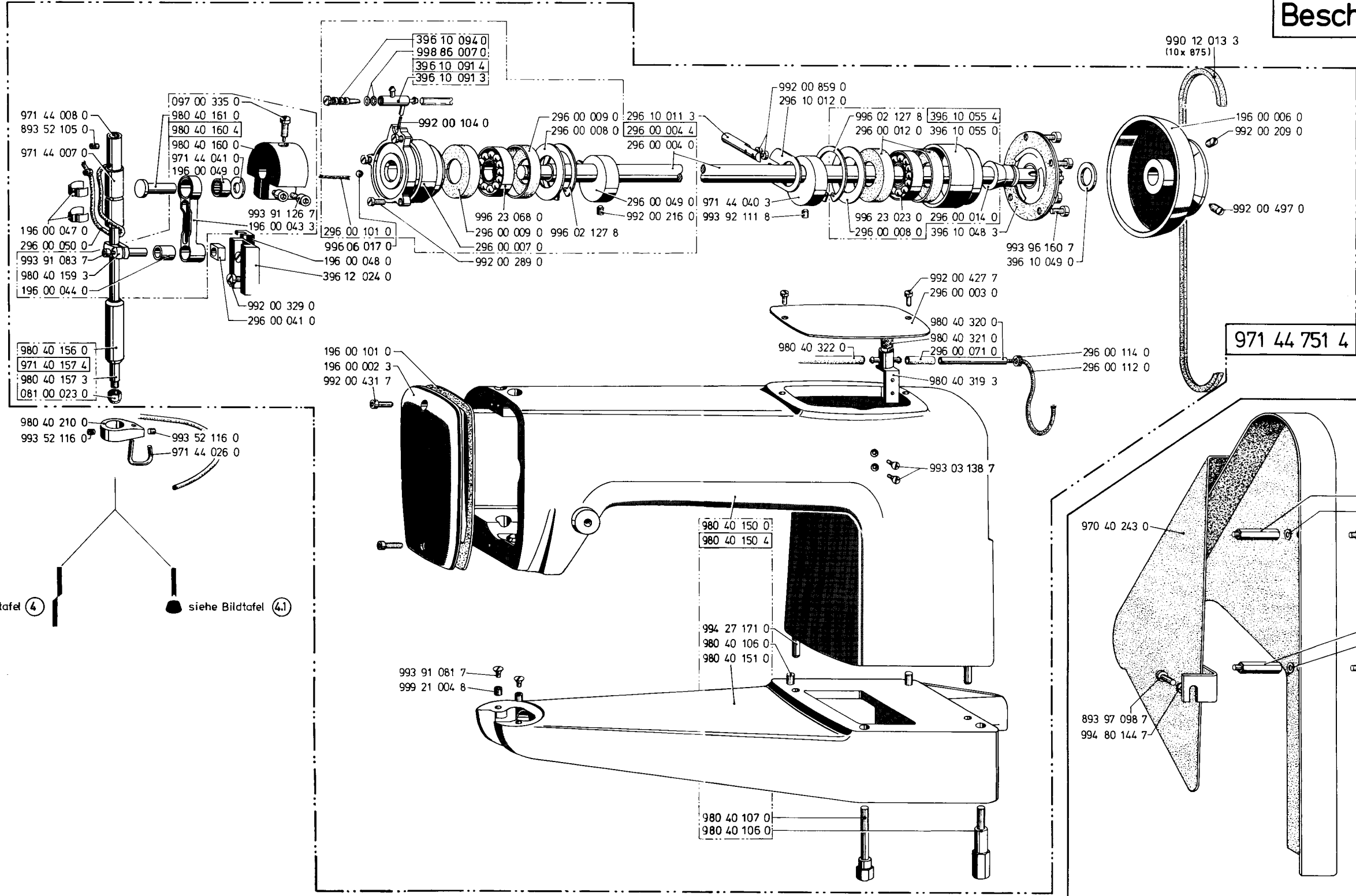

siehe Bildtafel 4

siehe Bildtafel 4.1

4

4

Scherkopfausführungen  
Shearing head types  
Machines a cuper  
Cachillas

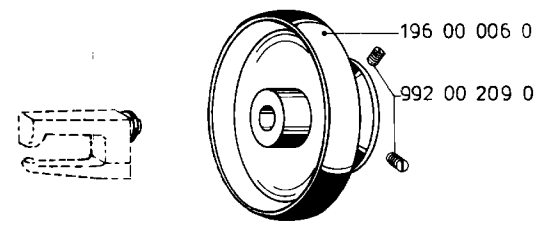
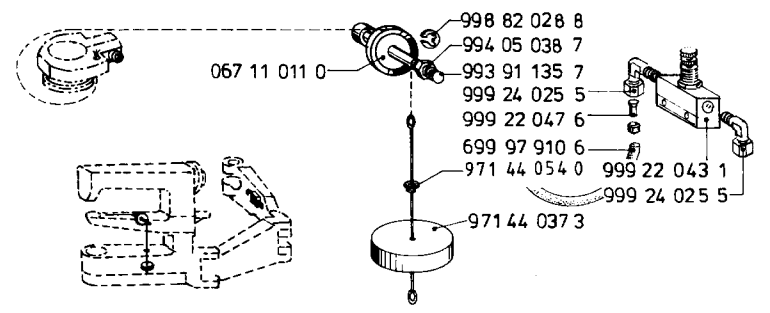
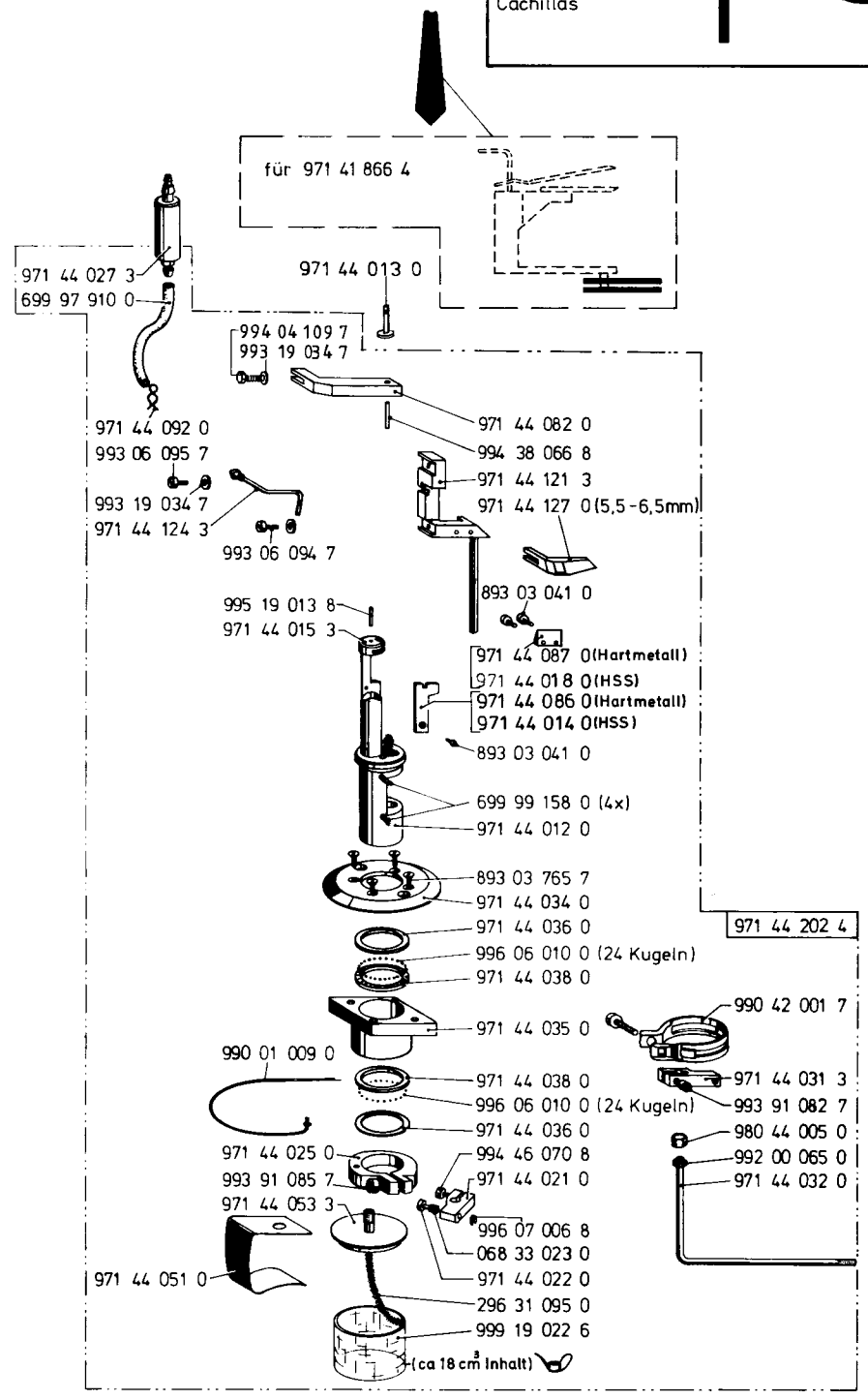
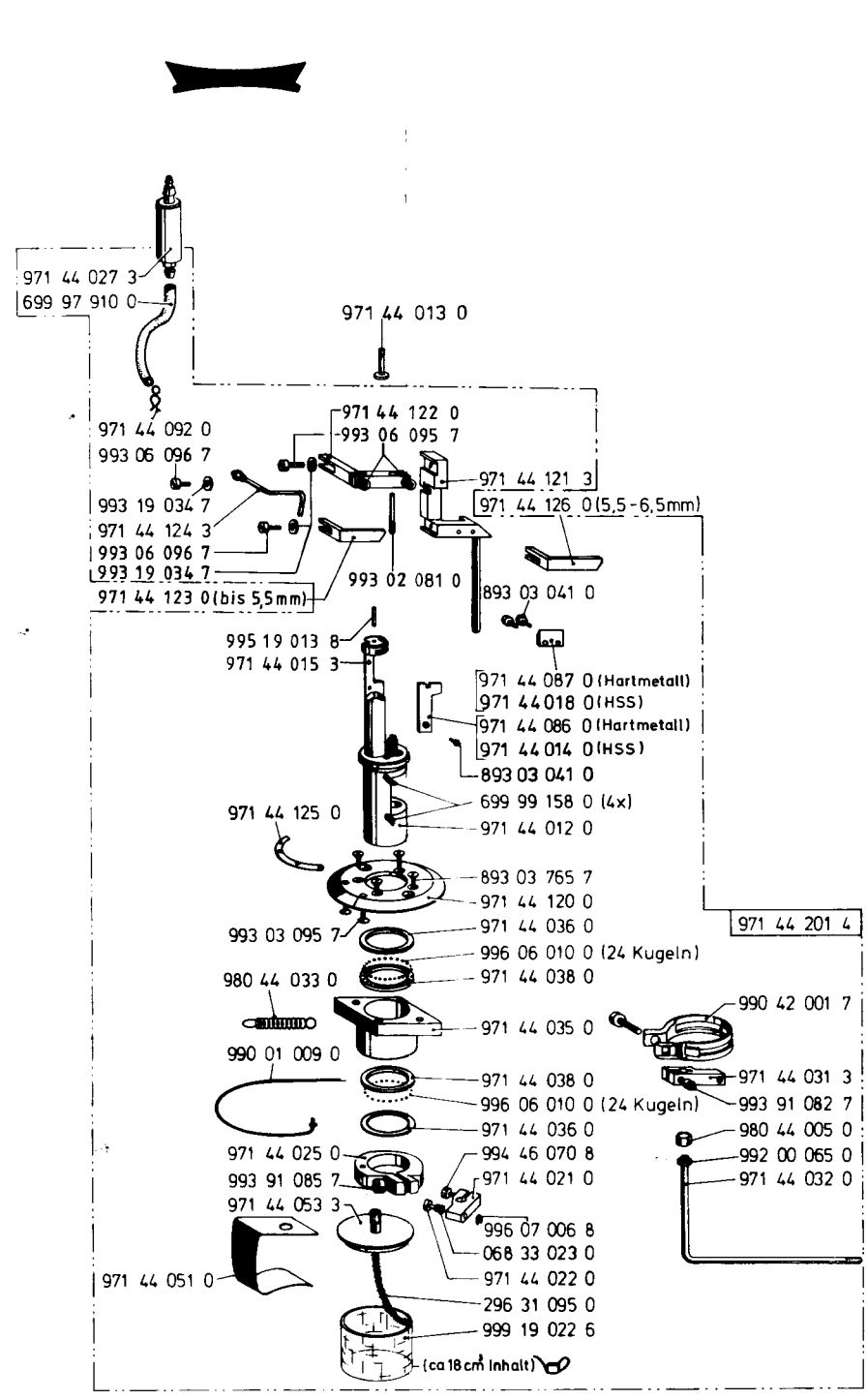
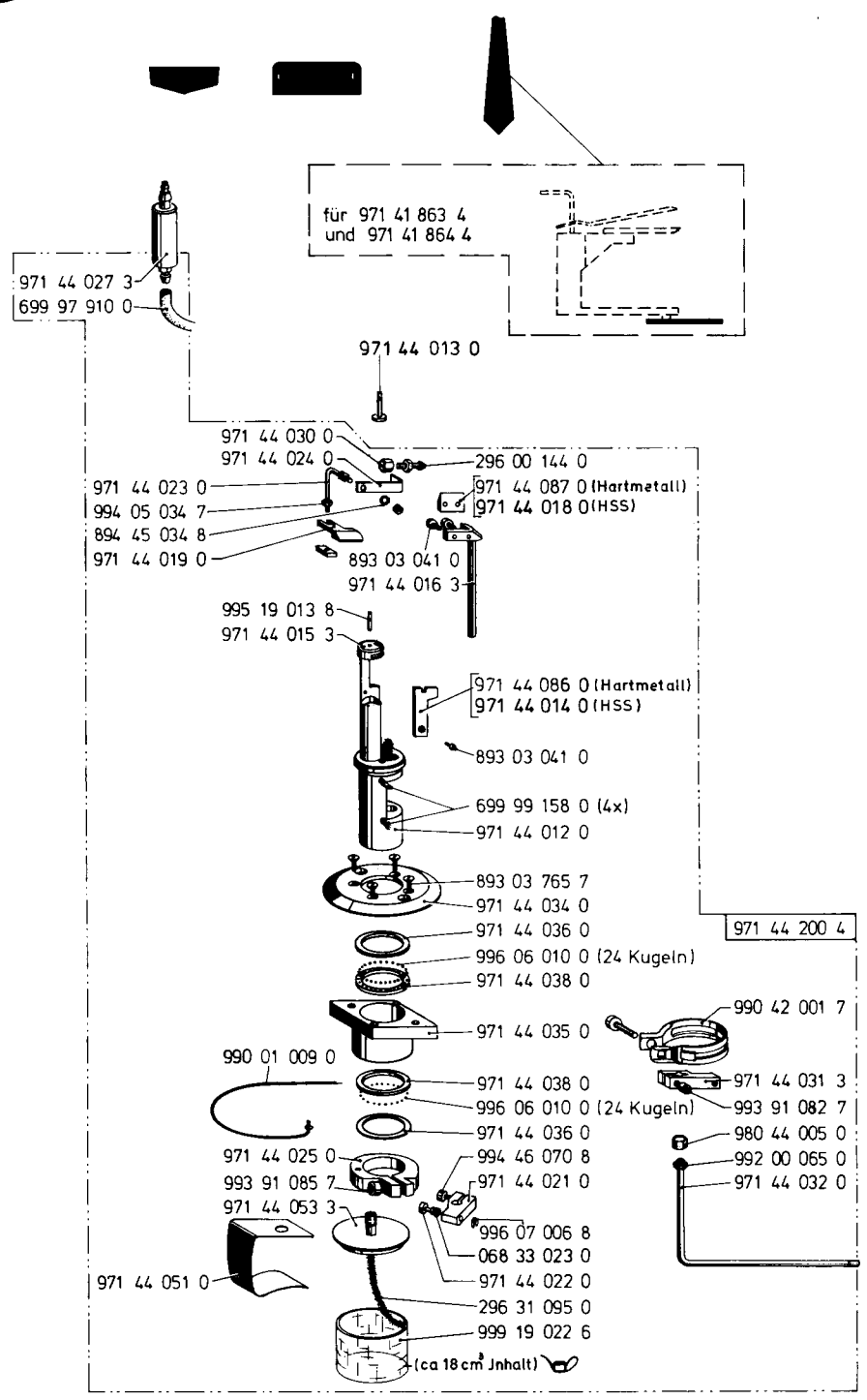

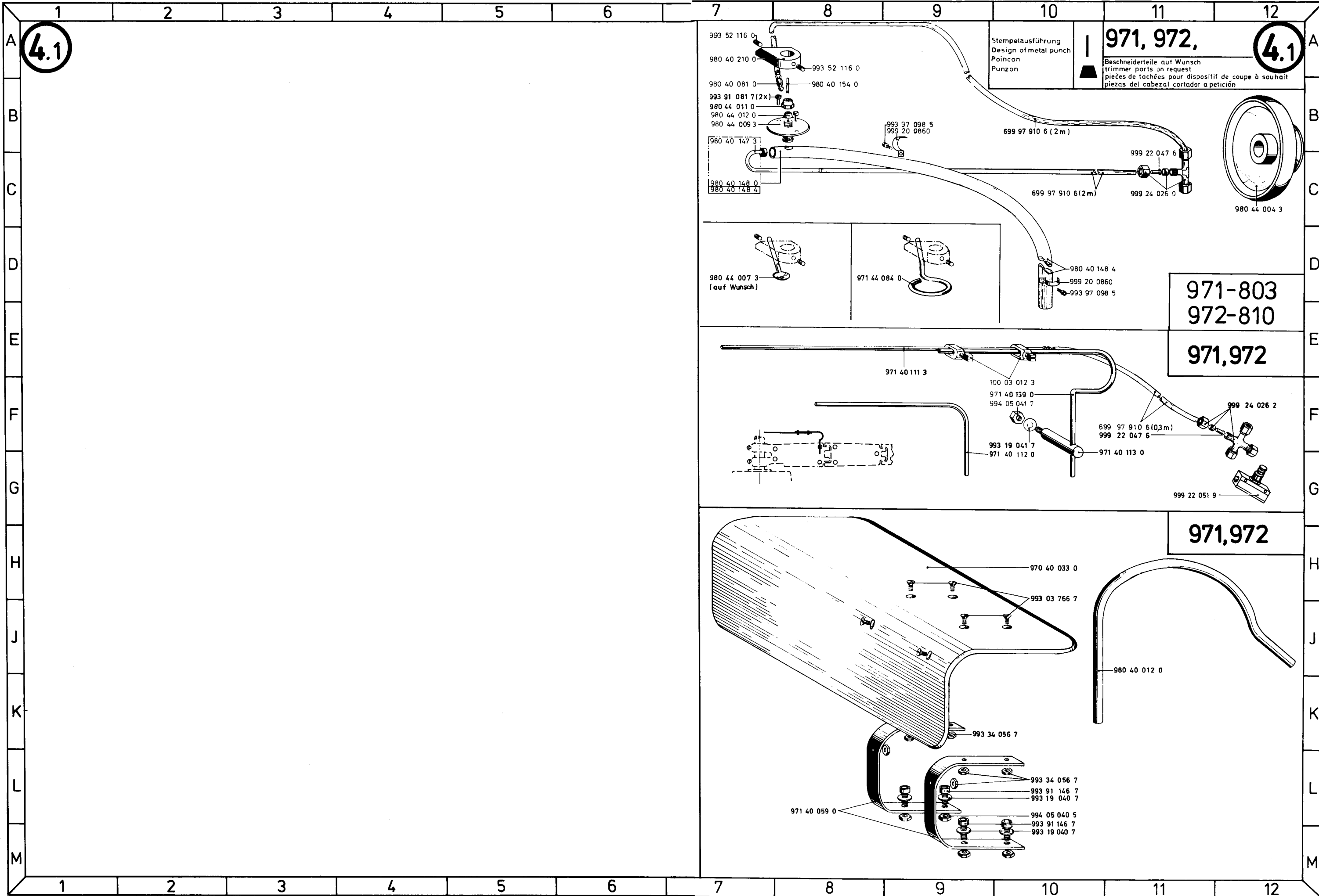

4.1

4.1

Stempelausführung  
Design of metal punch  
Poinçon  
Punzon

971, 972,

Beschneiderteile auf Wunsch  
trimmer parts on request  
pièces de tachées pour dispositif de coupe à souhait  
piezas del cabezal cortador a petición

971-803  
972-810

971,972

971,972



5 A

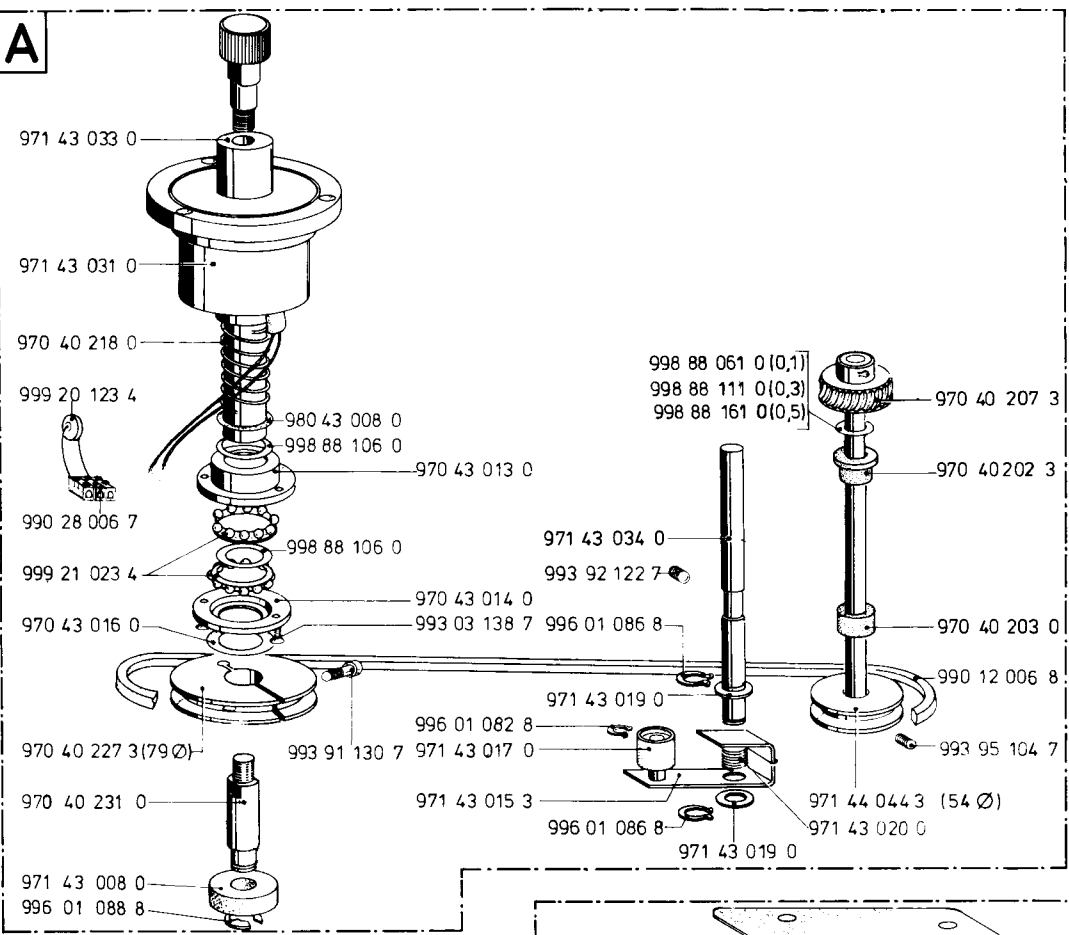

Einfachrolle  
A+C=971 43 101 4

siehe auch „Laufrollen  
und Keilriemenscheiben“  
Bildtafel ⑥

5 A

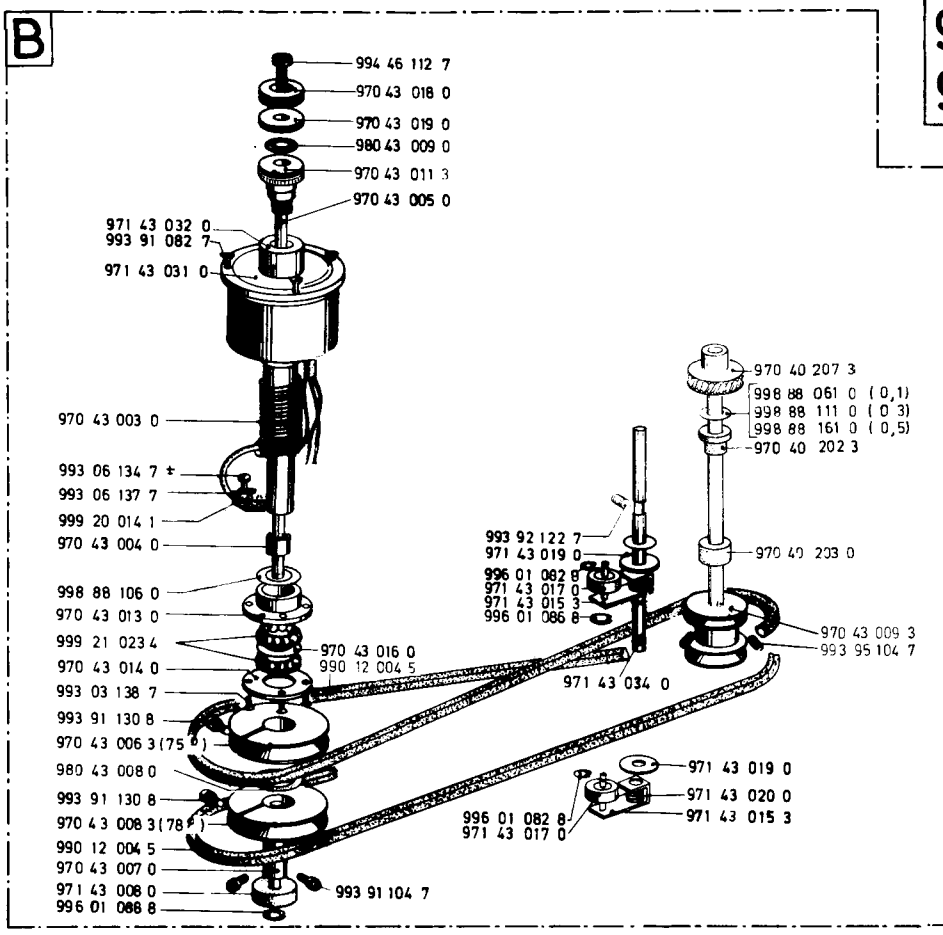

Doppelrolle  
B+C=971 43 102 4

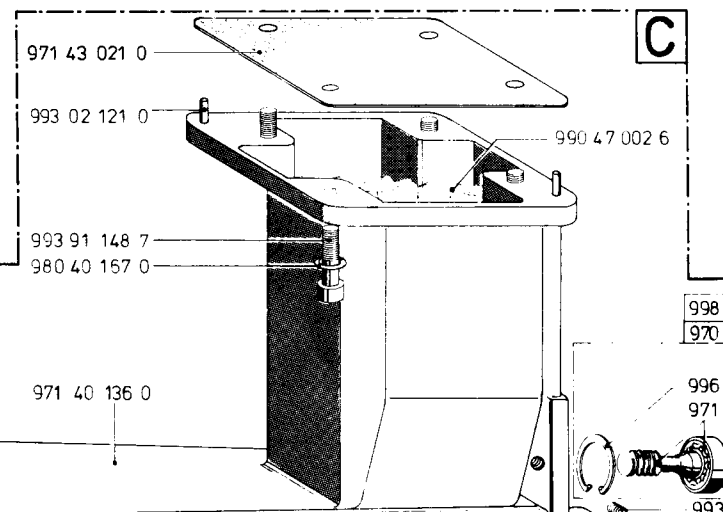

C

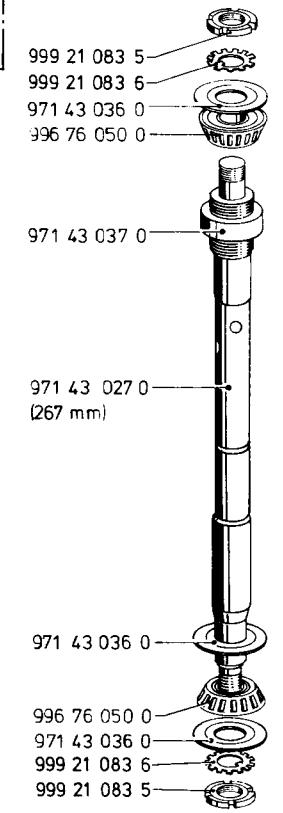
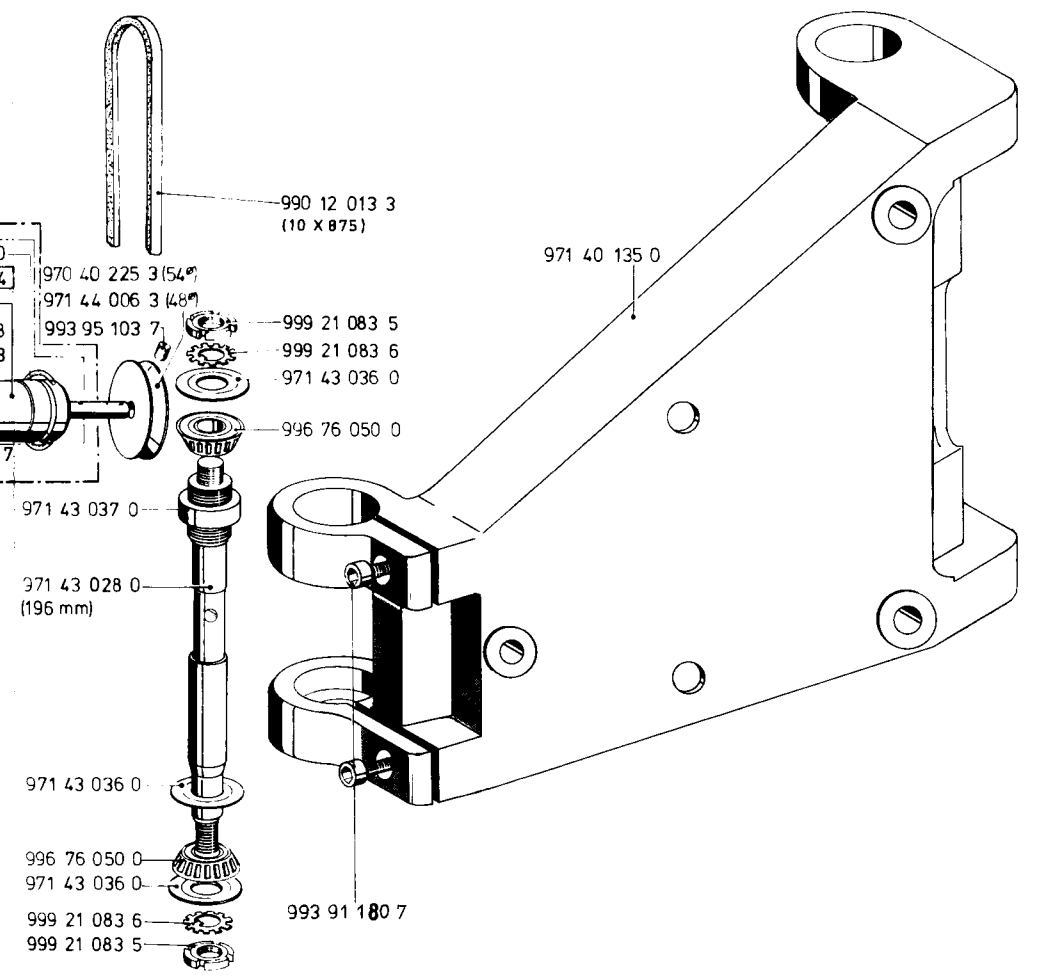
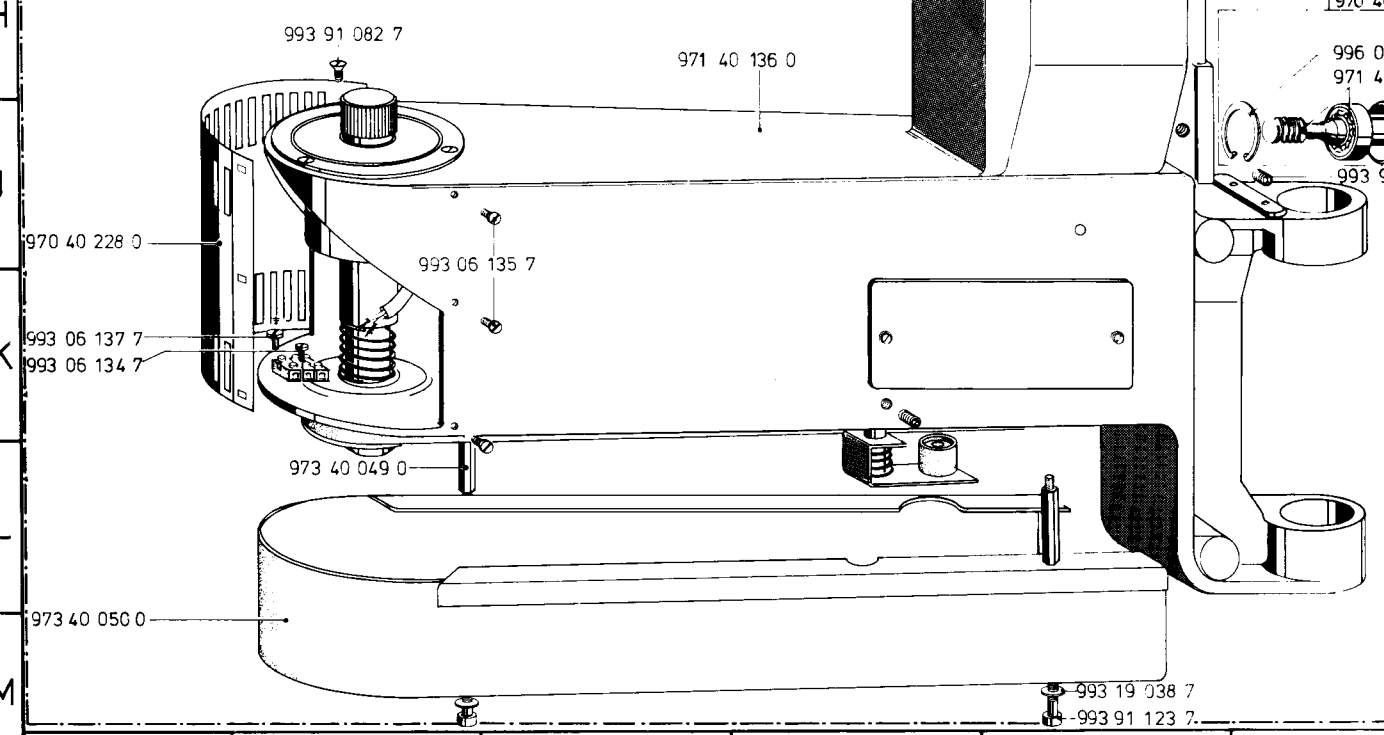

6

6

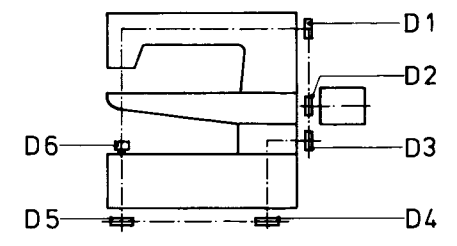
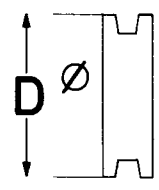

Keilriemenscheiben  
V-belt pulley  
poulie à courroie  
polea para correa trapezoidal

D1		D2		D3		D5		D4	
980 44 004 3	52 $\phi$	980 44 003 3	72 $\phi$	971 44 006 3	48 $\phi$	971 44 042 3	53 $\phi$	971 44 043 3	66 $\phi$
196 00 006 0	65 $\phi$	970 40 239 3	85 $\phi$	970 40 225 3	54 $\phi$	971 44 088 3	66 $\phi$	971 44 089 3	62 $\phi$
		971 44 005 3	97 $\phi$			971 44 045 3	72 $\phi$	971 44 044 3	54 $\phi$
		971 44 004 3	110 $\phi$			971 44 045 3	72 $\phi$	971 44 044 3	54 $\phi$
		971 43 035 3	68 $\phi$			970 40 227 3	79 $\phi$	970 40 226 3	48 $\phi$
						970 40 227 3	79 $\phi$	970 40 226 3	48 $\phi$
						971 44 088 3	66 $\phi$	971 44 089 3	62 $\phi$
						971 44 081 3	53	971 44 089 3	62 $\phi$

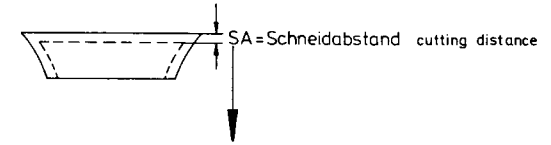

Klasse Class	E..	SA (mm)	D6 Laufrolle Roller	D3	D4 Keilriemenscheiben V-belt pulley	D5	Keilriemen V-belt	Verwendung Use
971-800 -820 -822	K971 E1	3,5	971 44 003 0 $\phi$ 18	970 40 225 3	971 44 044 3	971 44 045 3	990 12 006 8	Beschneider trimmer
	E2	4,5	971 44 002 0 $\phi$ 16	971 44 006 3	971 44 044 3	971 44 045 3	990 12 006 8	
	E3	5,5	971 44 047 0 $\phi$ 14	970 40 225 3	971 44 089 3	971 44 088 3	990 12 006 8	
	E4	6,5	971 44 079 0 $\phi$ 12	971 44 006 3	971 44 089 3	971 44 088 3	990 12 006 8	
			970 40 230 0 $\phi$ 27	970 40 225 3	970 40 226 3	970 40 227 3	990 12 006 8	Nähmaschine sewing machine
971-801	E5	5,5	971 44 080 0 $\phi$ 14	970 40 225 3	971 44 089 3	971 44 088 3	990 12 006 8	Beschneider trimmer
			971 44 049 0 $\phi$ 12	970 40 225 3	971 44 089 3	971 44 081 3	990 12 005 4	Nähmaschine sewing machine
971-803	E6	2,5	971 44 048 0 $\phi$ 19	971 44 006 3	970 40 226 3	970 40 227 3	990 12 006 8	Beschneider trimmer
			971 44 049 0 $\phi$ 12	970 40 225 3	971 44 043 3	971 44 042 3	990 12 004 5	Nähmaschine sewing machine

Laufrollen Roller Poulie Roldana	Teilenummer Comp.number Num.de la pièce Numero de pieza	Abmessung mm Dimension mm Dimensión mm						SA (mm)	Klasse Class Classe	
		D6	A	B	C	D	E		F	
	971 44 079 0	58	39	19	12			6,5	971	972
	980 40 171 0	54	39	15	16			4,5	971	972
	971 44 002 0	58	39	19	16			4,5	971	972
	971 44 003 0	58	39	19	18			3,5	971	972
	971 44 046 0	51	35	14,5	12				971	972
	971 44 047 0	58	39	19	14			5,5	971	972
	971 44 048 0	58	39	19	19				971	972
	980 40 170 0	54	39	15	20			2,5	971	972
	970 40 230 0	54	39	15	27				971	972
	980 40 172 0	54	39	15	36				971	972
	980 40 173 0	64	49	15	16			4,5	980	
	980 40 176 0	64	49	15	18			3,5	980	
	980 40 174 0	64	49	15	20			2,5	980	
	980 40 177 0	64	49	15	27				980	
	980 40 175 0	64	49	15	36				980	
971 44 080 0	50	39	11	14			5,5	971	972	
	994 46 112 7								971	972
	970 43 018 0				27	5			971	972
	971 43 005 0	49	10	27					971	972
	994 46 112 7								971	972
	970 43 018 0				27	5	I		971	972
	970 43 019 0				27	5	II	ohne Flexi-nähguthalter	971	972
970 43 011 3	30	9	27			III		971	972	
	I 973 43 055 0				27	5	I		972	
	II 973 43 056 0				27	5	II	mit Flexi-nähguthalter	972	
	III 970 43 011 3	30	9	27			III		972	
	970 44 001 0	58	40,5	7,5	14	5	5	5,5	971	972
	970 44 002 0	58	39,5	8,5	16	5	5	4,5	971	972
	970 43 012 0	58	39	9	18	5	5	3,5	971	972
	971 44 085 0	58	37	6	12	5	5	6,5	971	972



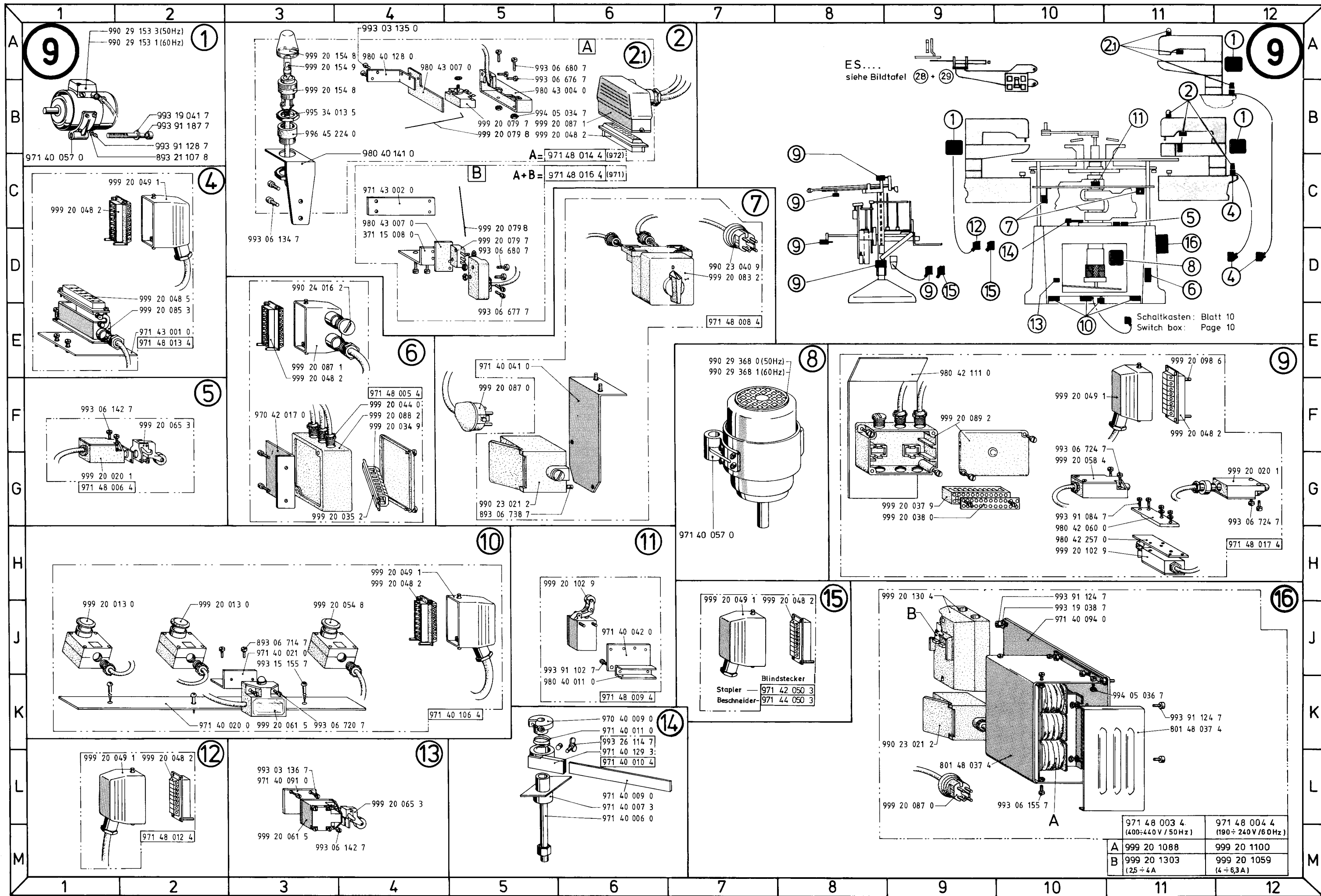

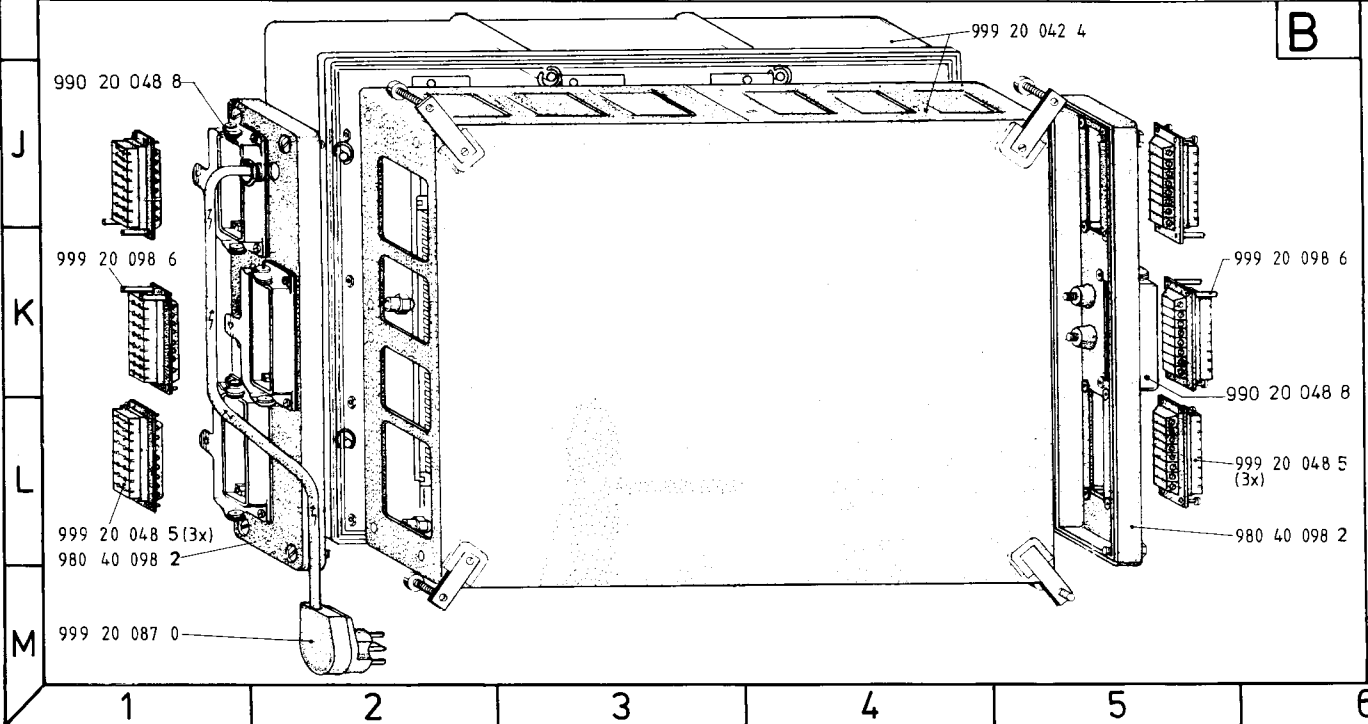
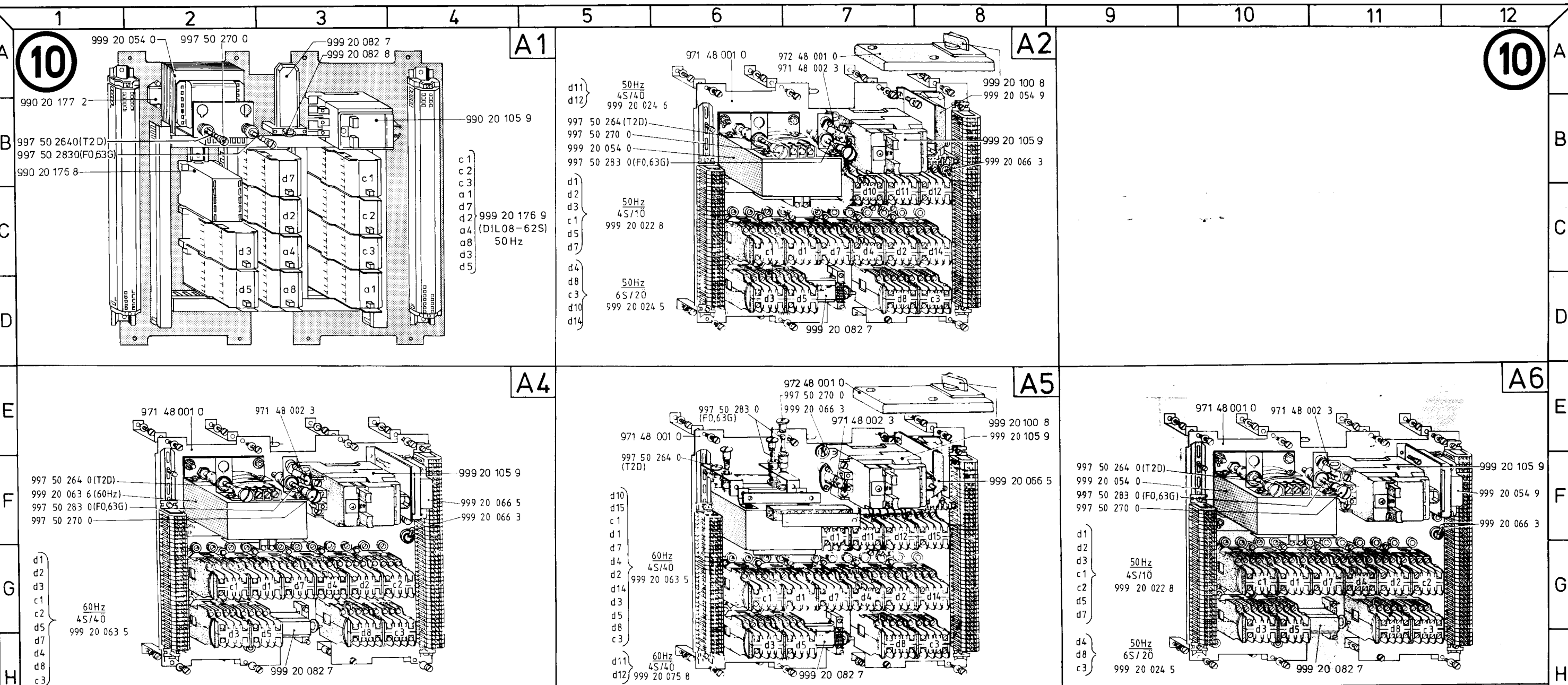

	besteht aus	Hz	für	Bemerkung
971 48 751 4	A6 + B	50	ohne ES	veraltet ersetzt durch 971 48 755 4
971 48 752 4	A4 + B	60	ohne ES	
971 48 753 4	A2 + B	50	mit ES 972-210	
971 48 754 4	A5 + B	60	mit ES 972-210	
971 48 755 4	A1 + B	50	ohne ES	ersatz für 971 48 751 4



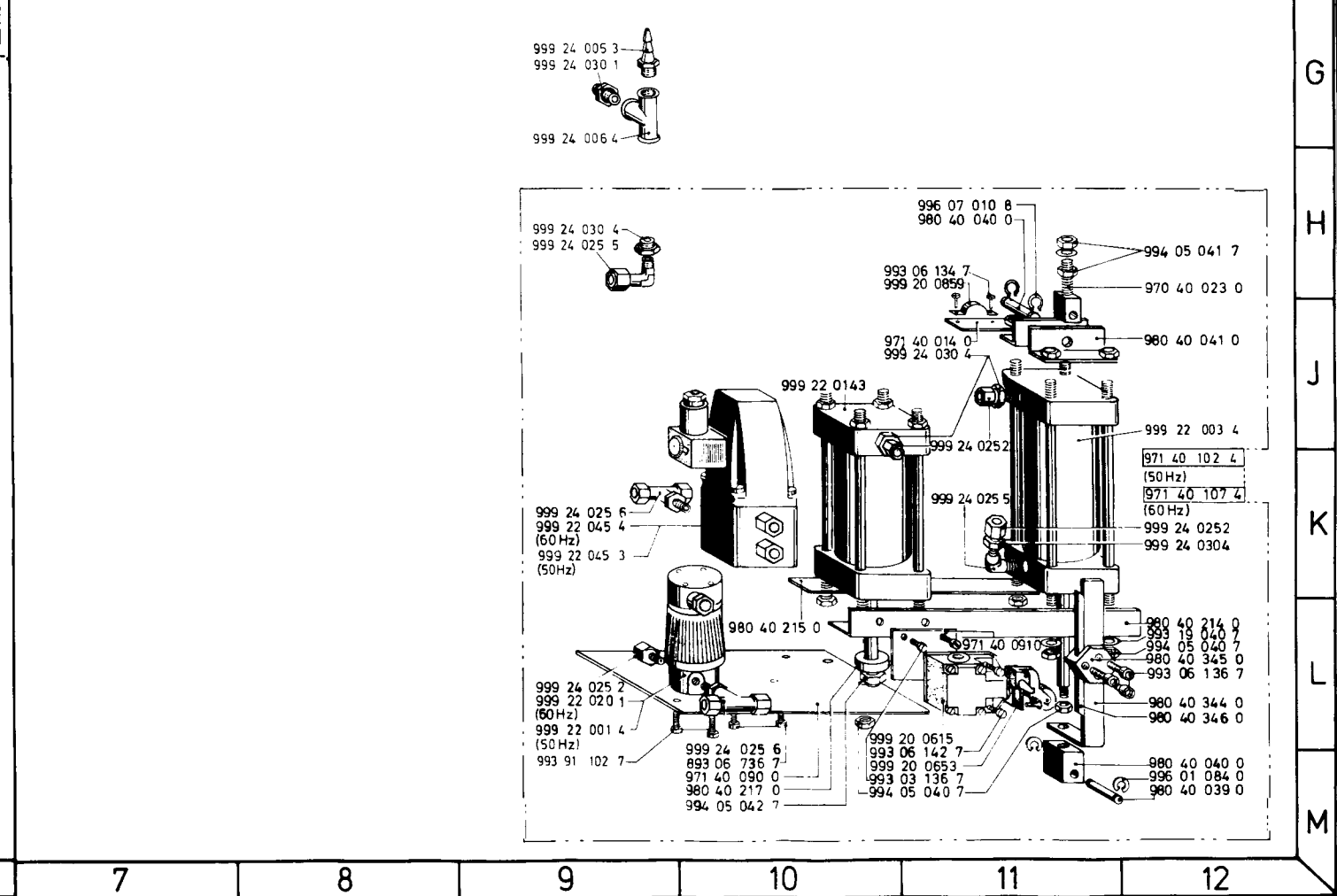
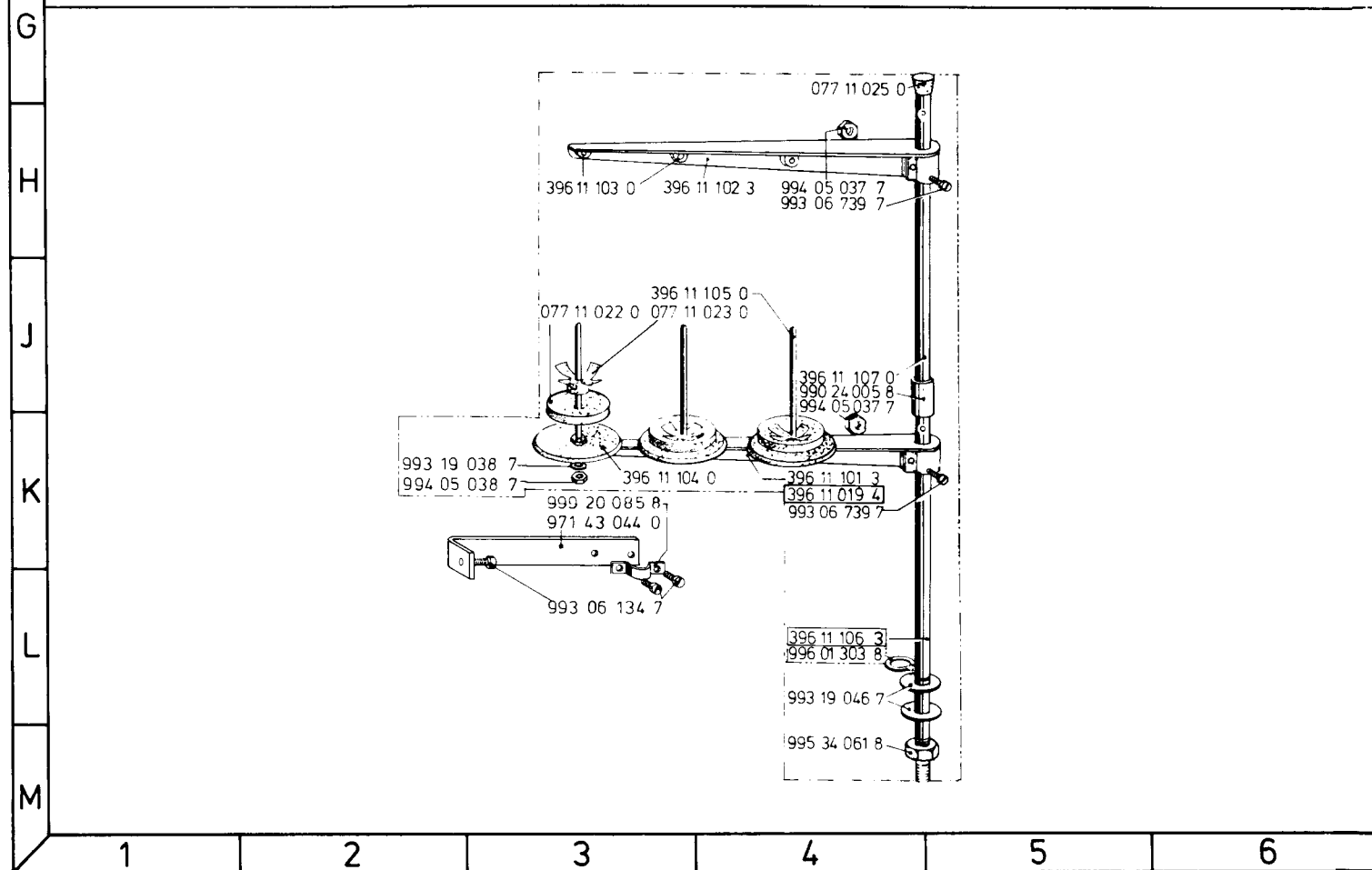
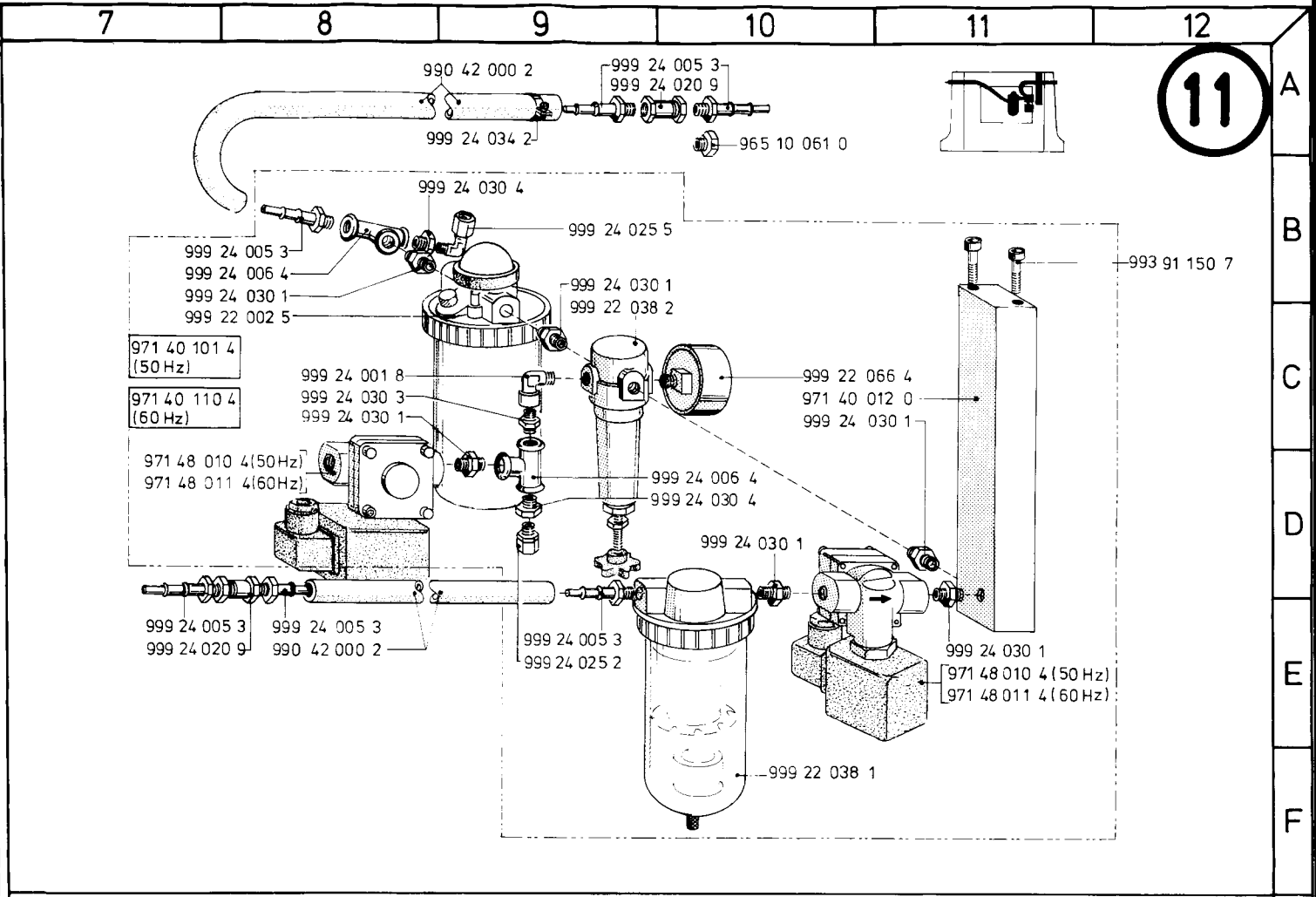
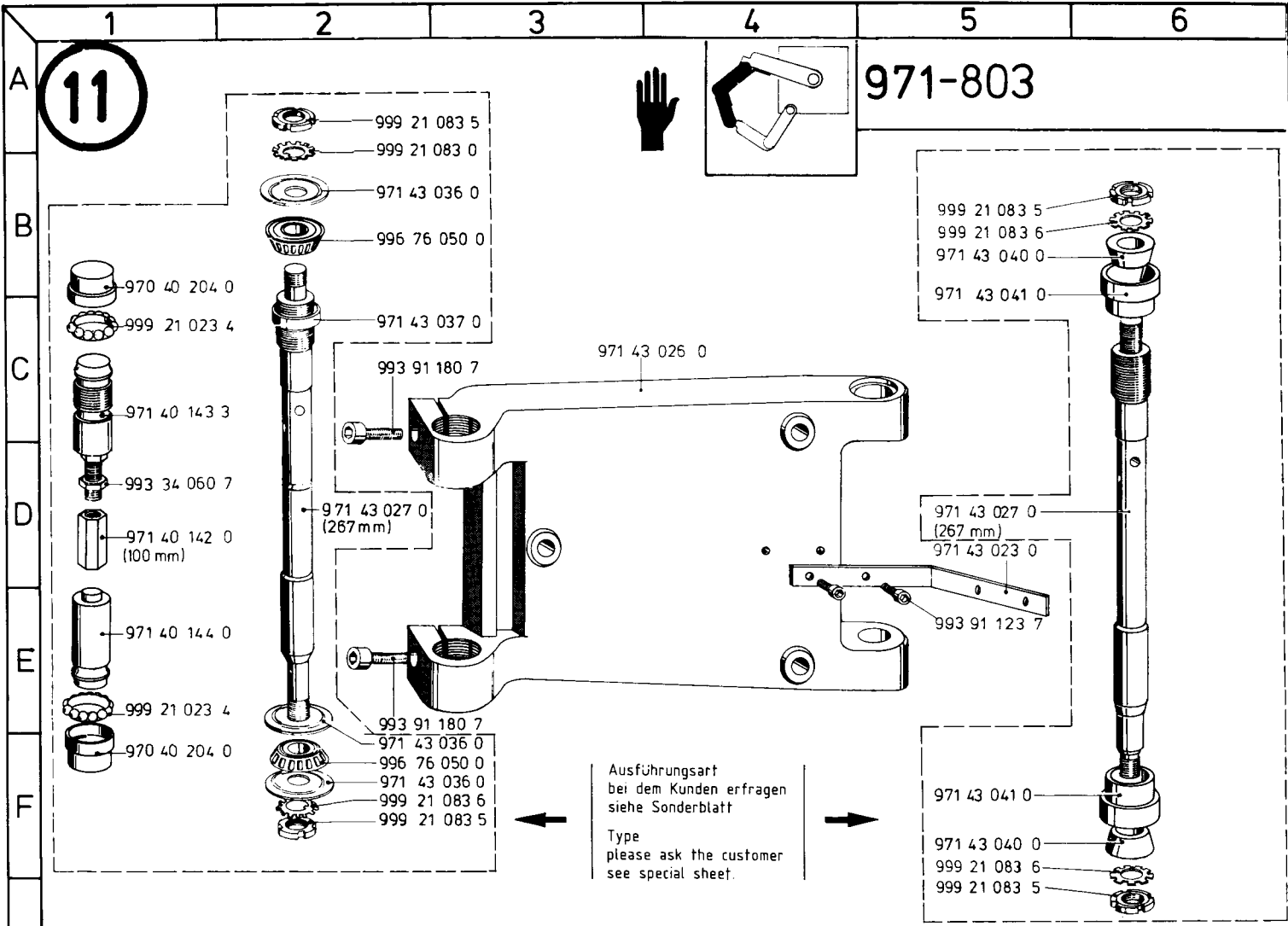

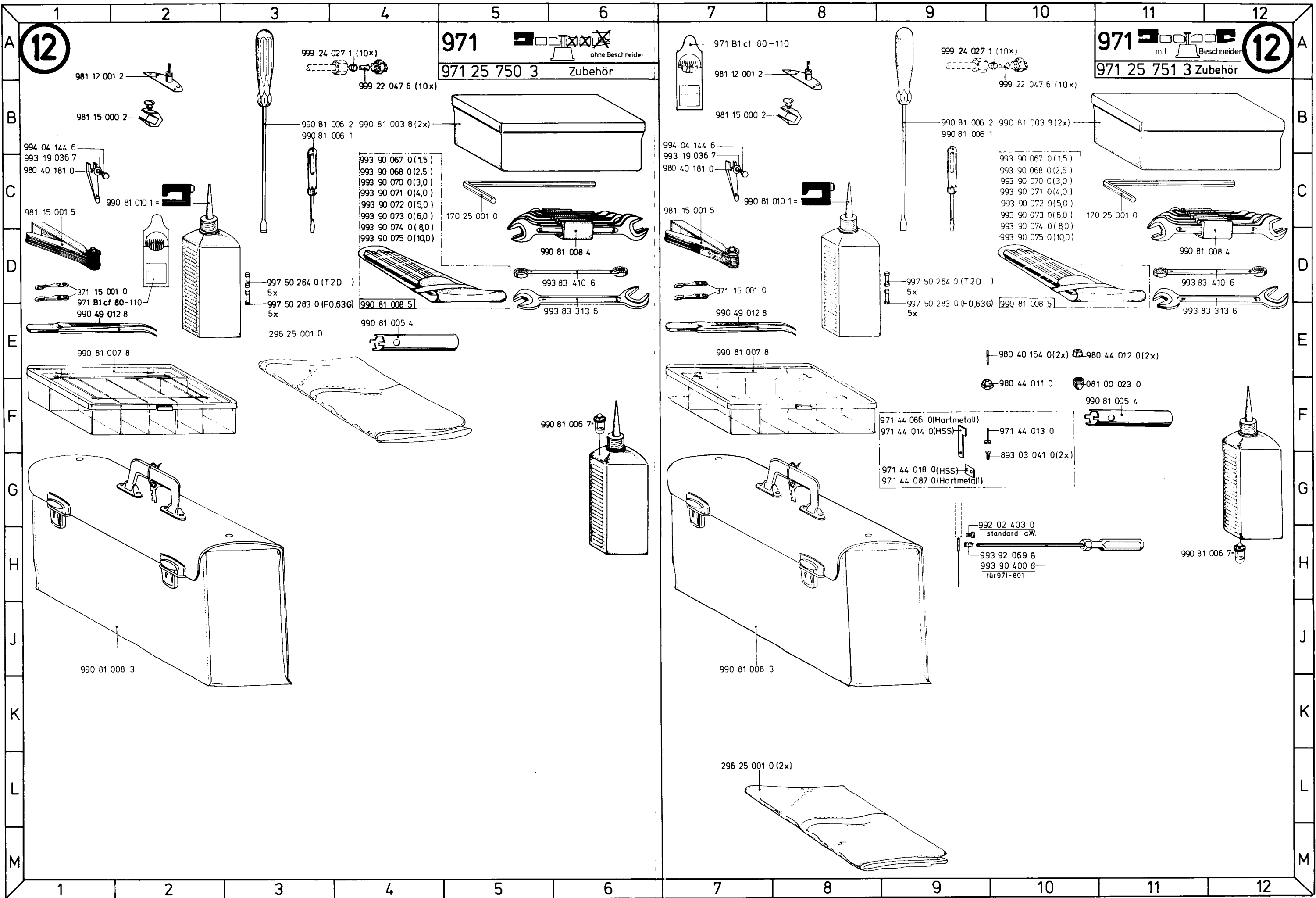

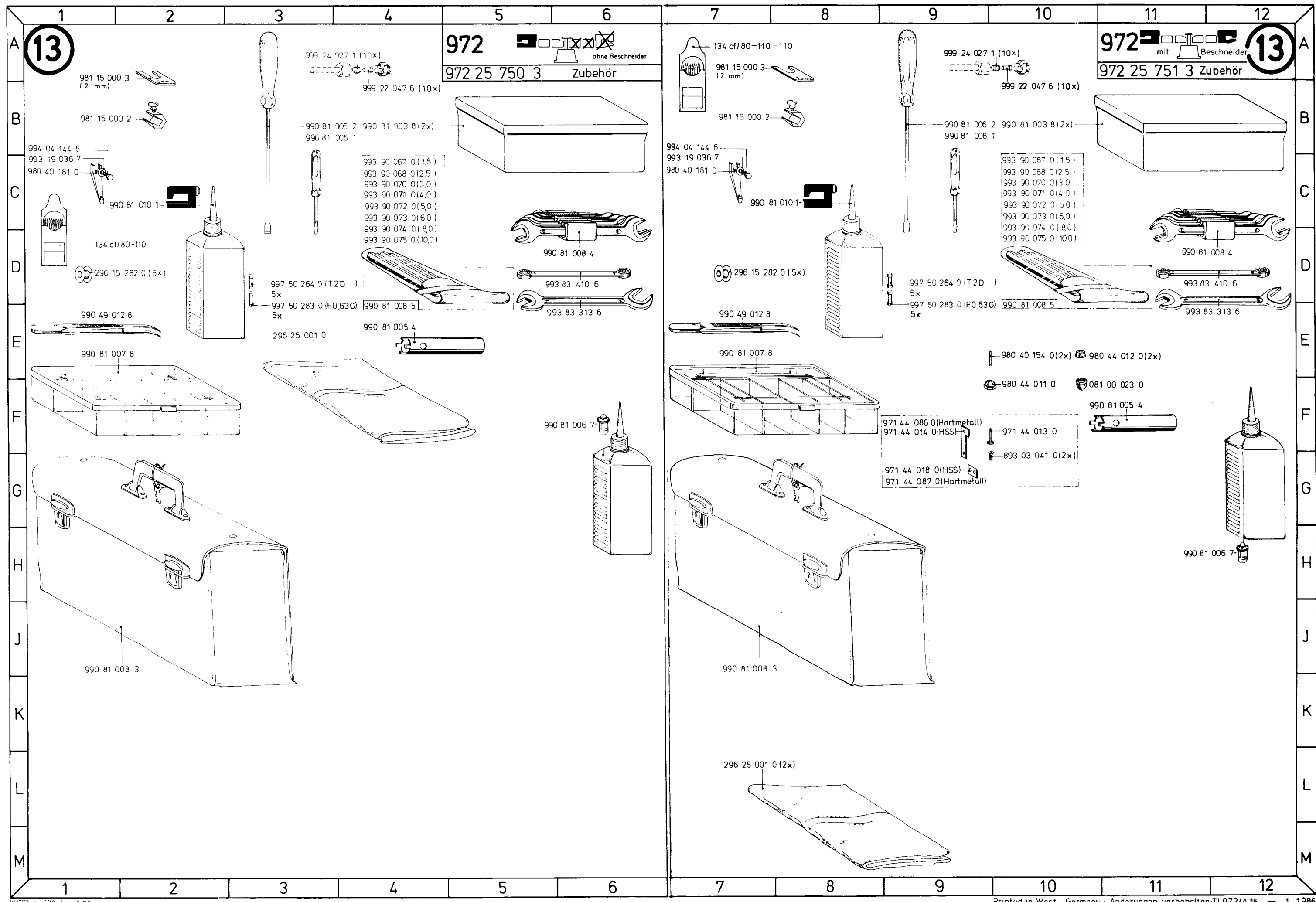

13

13

972 ohne Beschneider  
972 25 750 3 Zubehör

972 mit Beschneider  
972 25 751 3 Zubehör

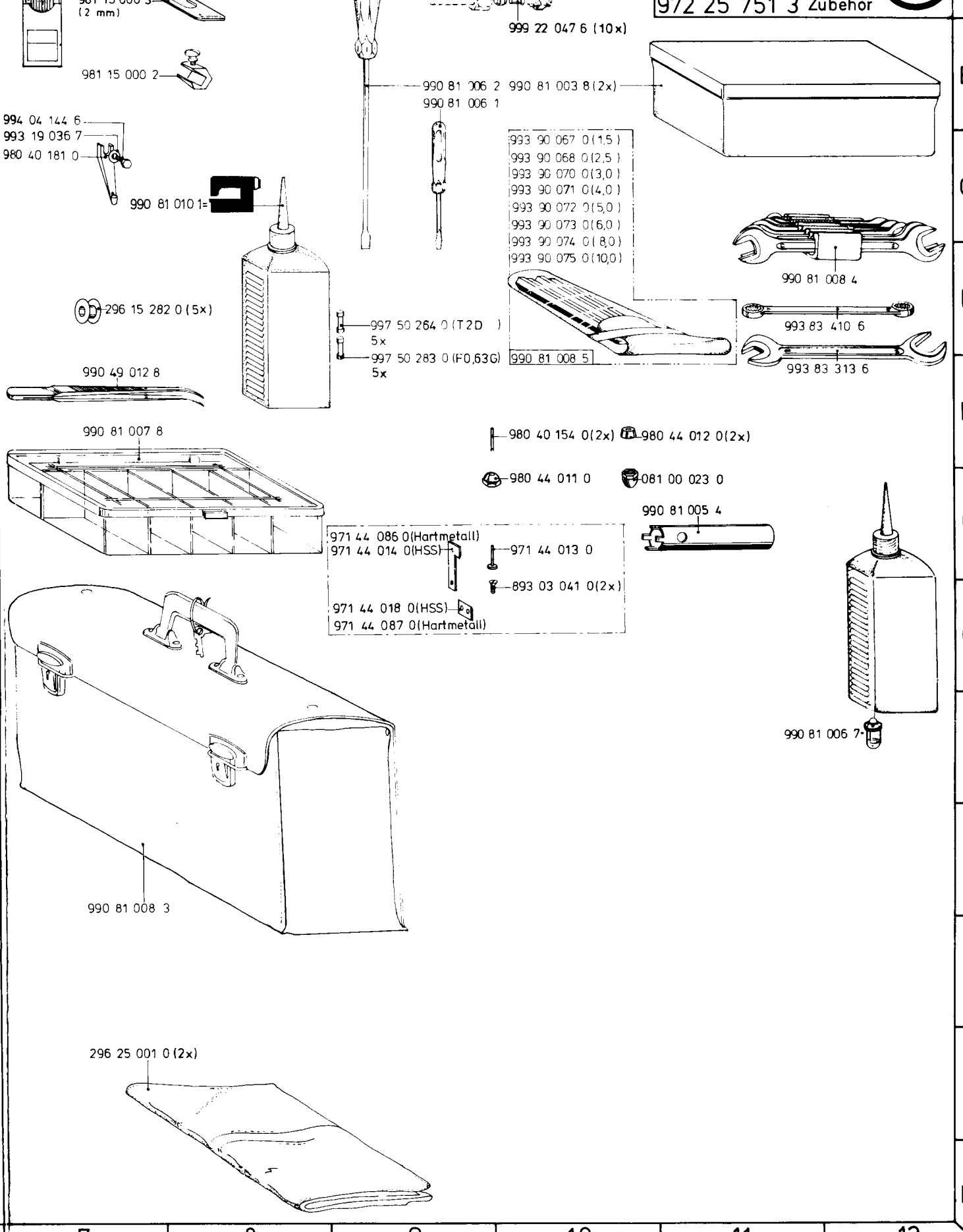
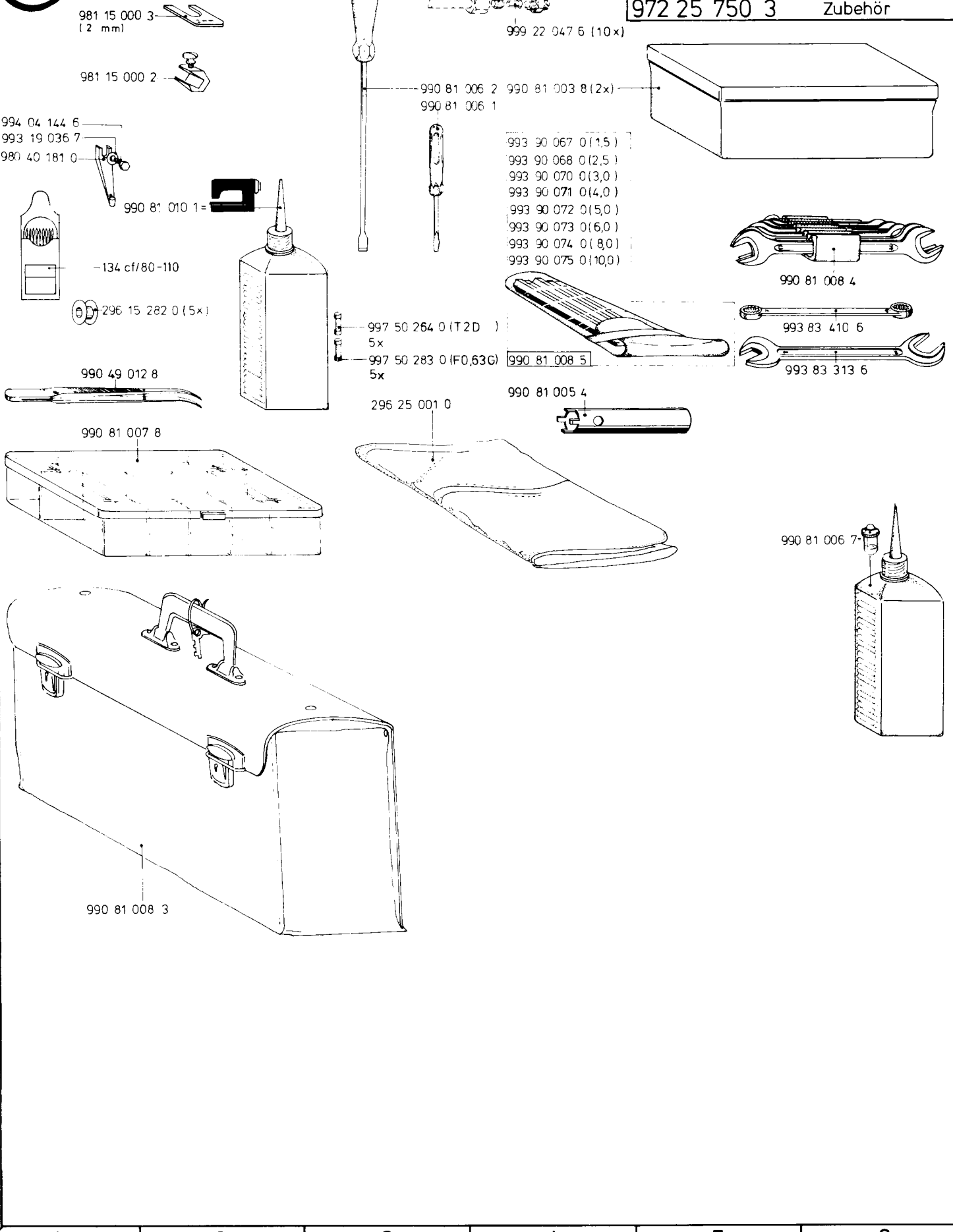

pneumatische Schere

Umbau von Kl. 971-820 in Kl. 971-822

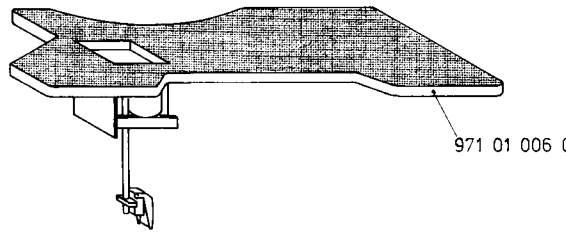

971 01 006 0

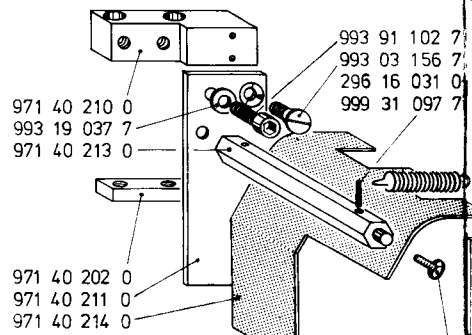

971 40 210 0  
993 19 037 7  
971 40 213 0  
993 91 102 7  
993 03 156 7  
296 16 031 0  
999 31 097 7

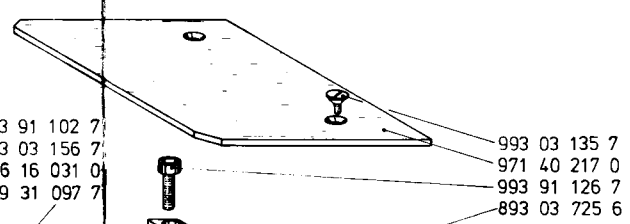

993 03 135 7  
971 40 217 0  
993 91 126 7  
893 03 725 6

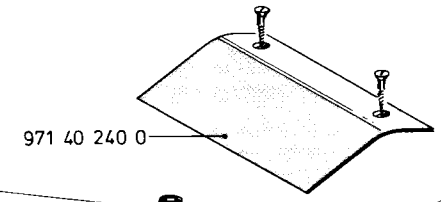

971 40 240 0

993 03 178 7  
971 40 191 0  
993 03 156 7  
999 24 025 5  
999 22 050 1  
999 24 025 8

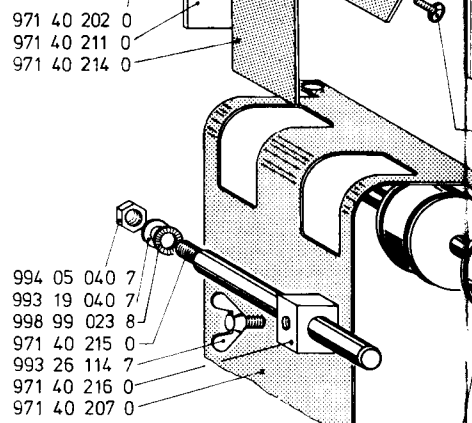

971 40 202 0  
971 40 211 0  
971 40 214 0  
994 33 075 0  
993 91 124 7  
971 40 209 0  
971 40 208 0  
993 91 125 7  
993 15 156 7  
971 40 210 0  
971 40 212 0  
993 03 137 7  
971 40 192 3  
971 40 202 0  
971 40 203 0

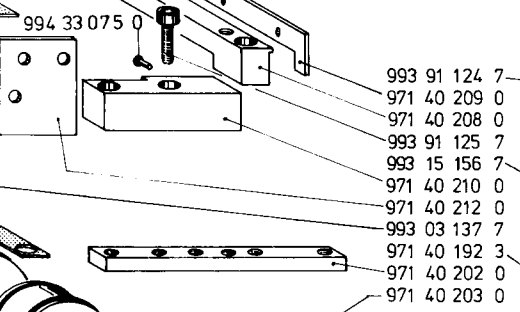

994 05 040 7  
993 19 040 7  
998 99 023 8  
971 40 215 0  
993 26 114 7  
971 40 216 0  
971 40 207 0

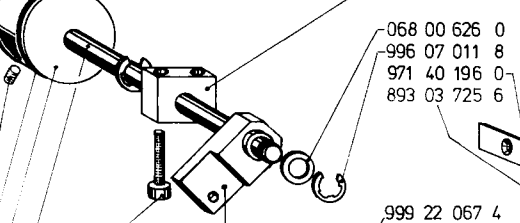

993 95 104 7  
998 86 320 0  
971 40 205 0  
971 40 204 0  
993 91 129 7

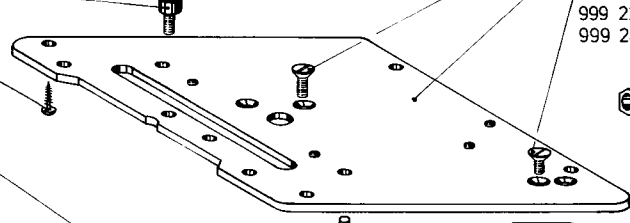

068 00 626 0  
996 07 011 8  
971 40 196 0  
893 03 725 6

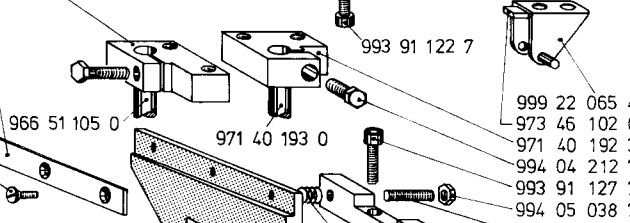

999 22 065 4  
973 46 102 0  
971 40 192 3  
994 04 212 7  
993 91 127 7  
994 05 038 7  
993 27 133 7  
971 40 198 0  
067 00 930 0  
971 40 195 0  
971 40 197 0  
999 23 024 8  
971 40 194 3  
802 41 559 0  
996 07 008 8  
973 45 229 0  
993 06 146 7  
999 22 072 3  
999 24 030 2  
999 24 030 5  
999 24 030 2  
999 24 027 3  
999 22 051 9  
999 24 025 8  
699 97 910 6  
999 22 047 6

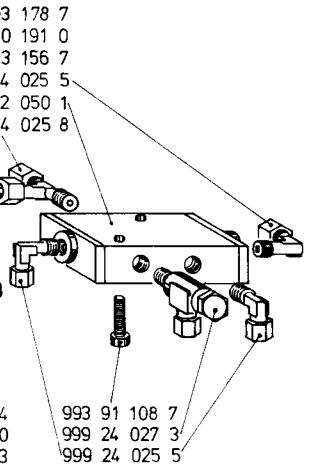

999 22 065 4  
973 46 102 0  
971 40 192 3  
994 04 212 7  
993 91 127 7  
994 05 038 7  
993 27 133 7  
971 40 198 0  
067 00 930 0  
971 40 195 0  
971 40 197 0  
999 23 024 8  
971 40 194 3  
802 41 559 0  
996 07 008 8  
973 45 229 0  
993 06 146 7  
999 22 072 3  
999 24 030 2  
999 24 030 5  
999 24 030 2  
999 24 027 3  
999 22 051 9  
999 24 025 8  
699 97 910 6  
999 22 047 6

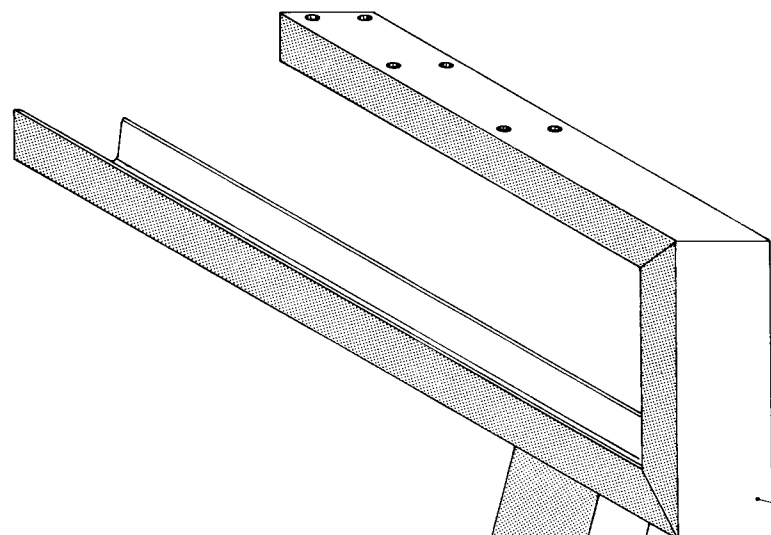

971 40 220 3  
993 91 122 7  
999 24 025 5  
999 22 051 9  
999 24 030 2  
999 22 072 7

996 07 015 8  
998 88 216 0  
971 40 231 3

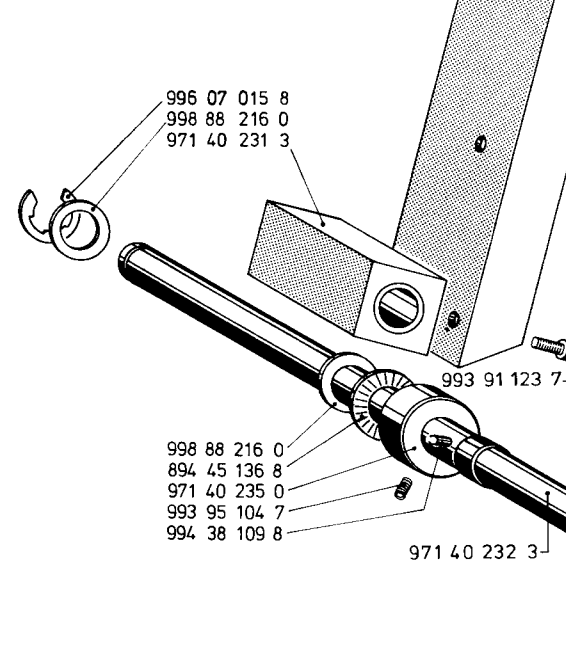

999 22 059 7  
999 22 059 6  
893 02 199 0  
993 91 127 7  
971 40 227 3  
993 91 123 7  
971 40 237 0  
971 40 238 0  
396 35 072 0  
998 88 216 0  
894 45 136 8  
971 40 235 0  
993 95 104 7  
994 38 109 8  
971 40 232 3  
971 40 225 0  
998 88 210 0  
894 45 036 8  
993 06 137 7  
999 22 067 1  
993 06 100 7  
994 38 066 8

972 44 064 0  
993 91 123 7  
971 40 224 0

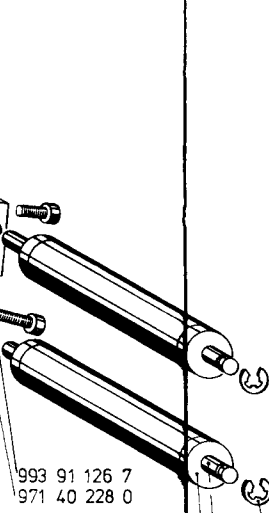

993 91 126 7  
971 40 228 0

996 07 009 8  
067 24 005 0  
971 40 230 3  
971 40 226 3  
993 91 124 7

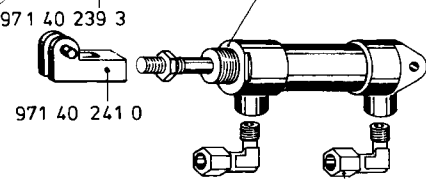

971 40 239 3  
971 40 241 0

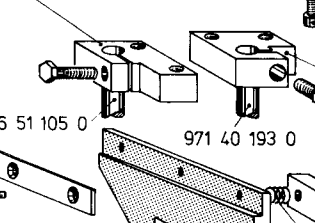

999 22 067 4  
998 88 052 0 0.1mm  
998 88 102 0 0.3mm  
993 95 104 7

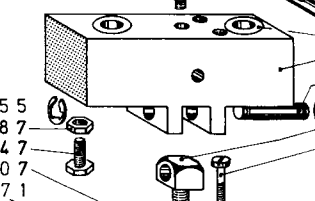

999 24 025 5  
994 05 038 7  
994 04 214 7  
993 06 100 7  
999 22 067 1

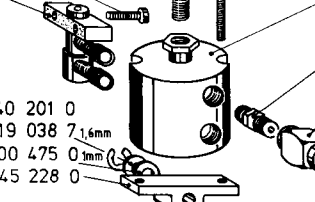

971 40 201 0  
993 19 038 7 1.6mm  
081 00 475 0 3mm  
973 45 228 0

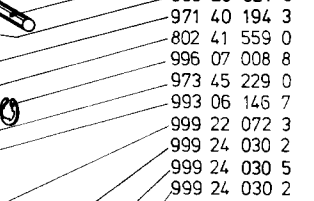

999 24 025 2  
999 24 025 6  
802 41 559 0  
996 07 008 8  
971 40 200 0  
993 91 130 7

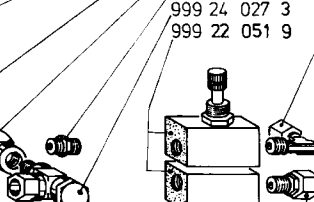

993 91 128 7  
993 91 110 7  
999 24 036 6  
999 24 036 5  
999 22 071 2

994 05 037 7  
994 05 038 7  
971 40 199 3  
999 24 034 4  
966 51 105 0  
971 40 207 0  
993 19 037 7  
994 04 178 7  
993 91 125 7  
971 40 219 3  
993 91 123 7

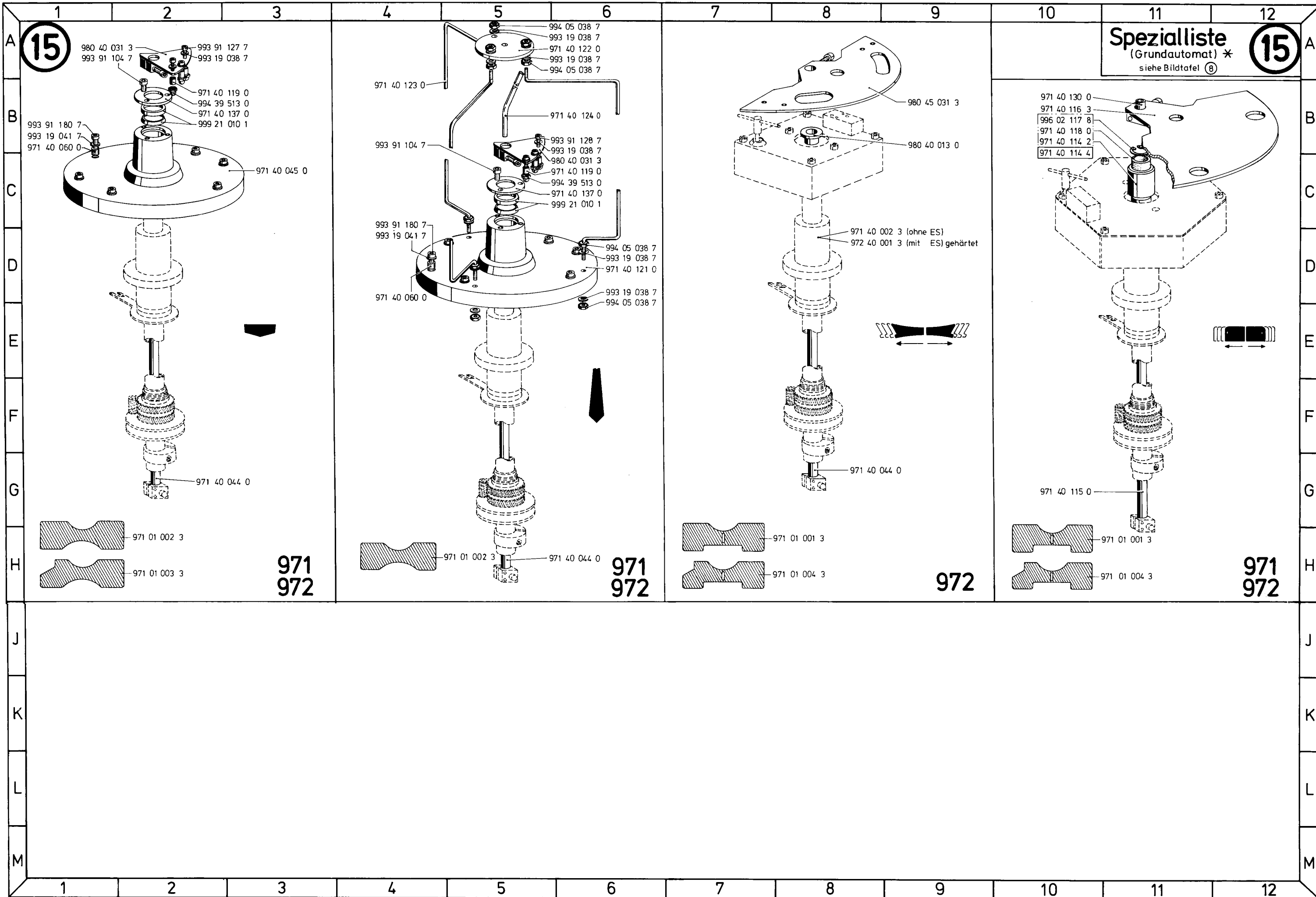

**Spezialliste**  
 (Grundautomat) \*  
 siehe Bildtafel ⑧

**15**

**15**

**971  
972**

**971  
972**

**972**

**971  
972**







17.1

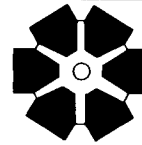

971  
972 -200; -800  
971 41 866 4 Krawatten

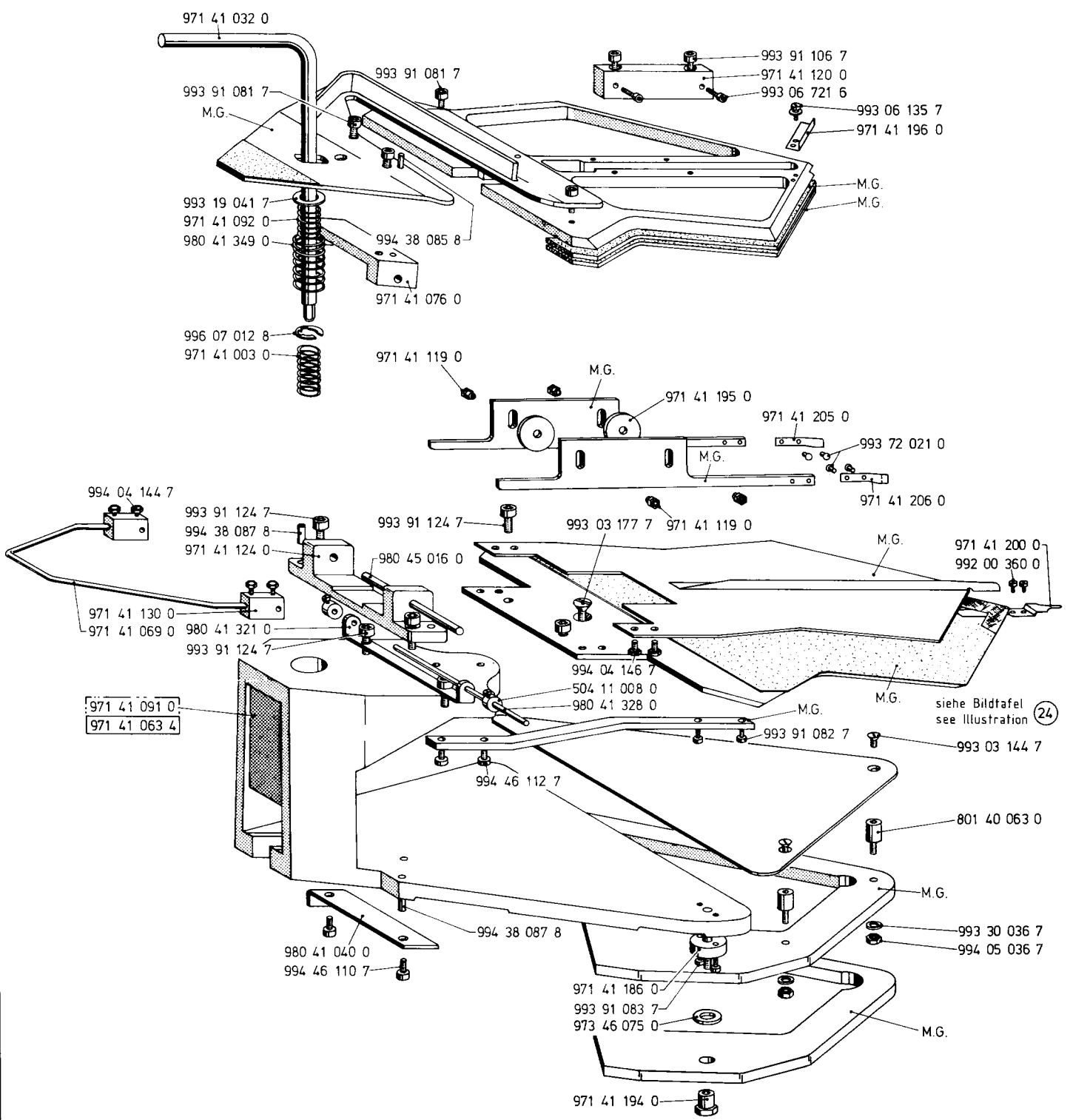

siehe Bildtafel  
see illustration (24)



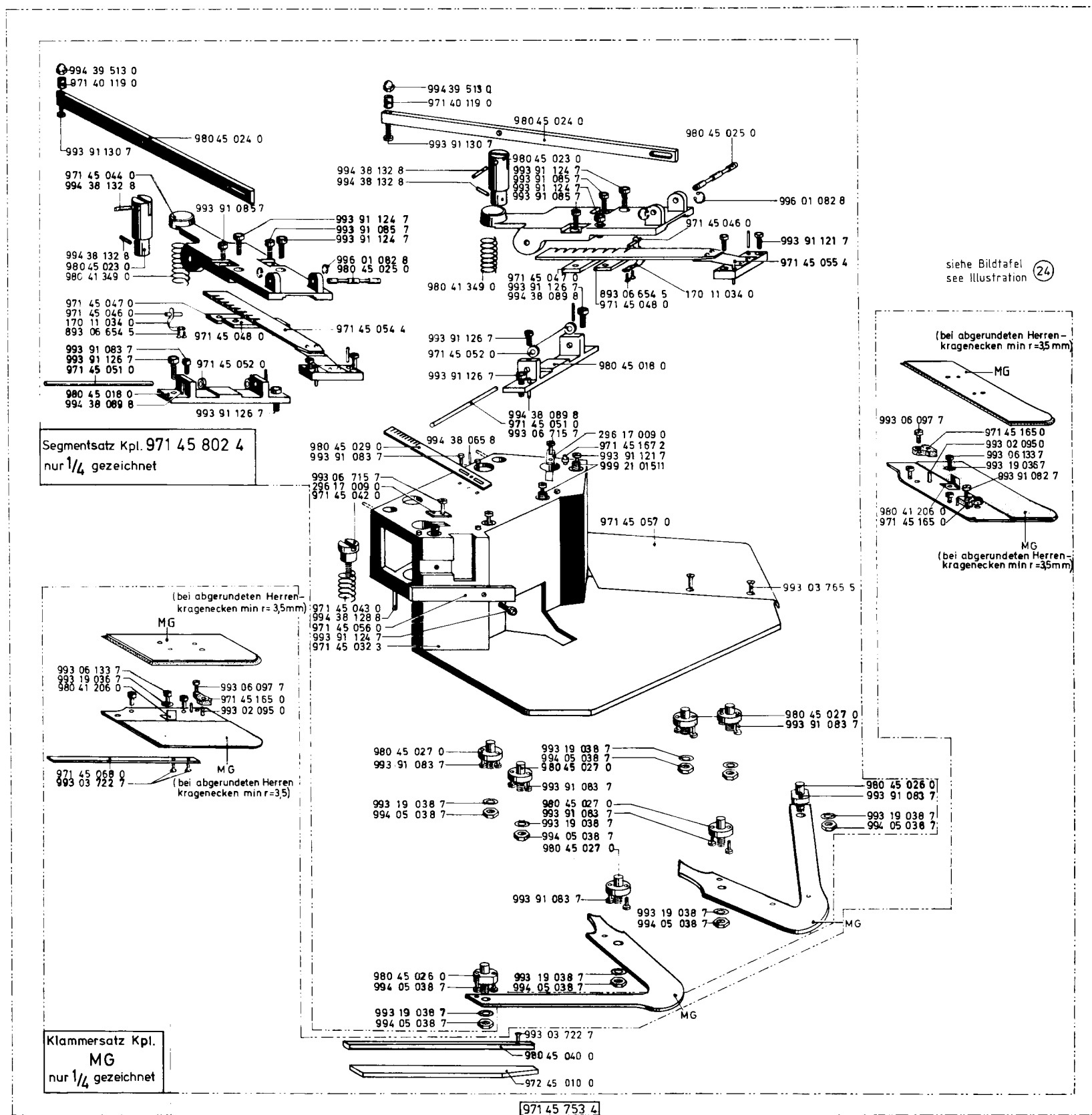

Segmentsatz Kpl. 971 45 802 4  
nur 1/4 gezeichnet

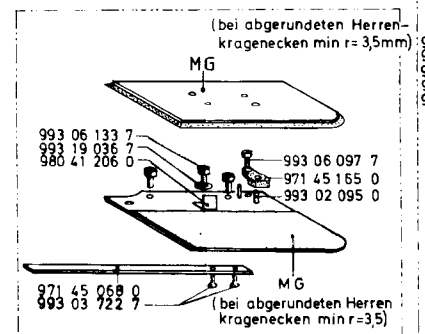

Klammersatz Kpl.  
MG  
nur 1/4 gezeichnet

siehe Bildtafel 24  
see illustration 24

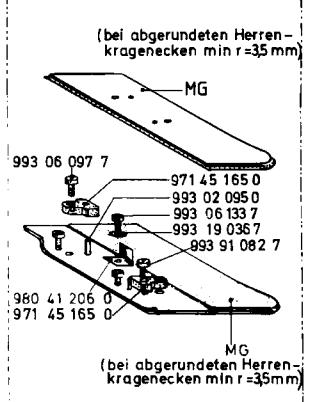

971 45 753 4







972 45 751 4 (Kinderkragen)

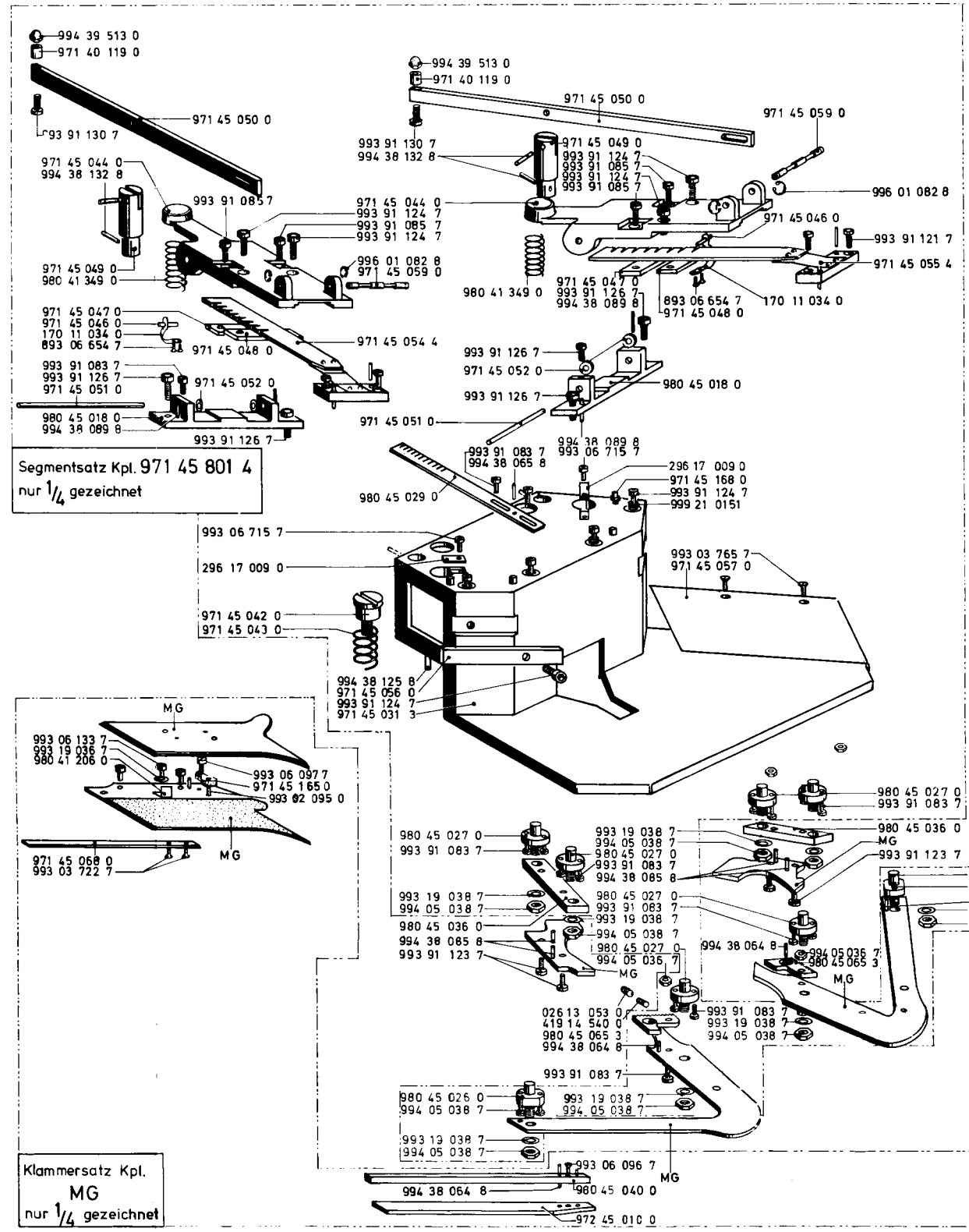

Segmentsatz Kpl. 971 45 801 4  
nur 1/4 gezeichnet

Klammersatz Kpl. MG  
nur 1/4 gezeichnet

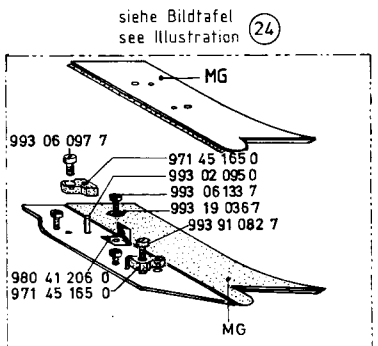



972 45 753 4 (Herrenkragen)

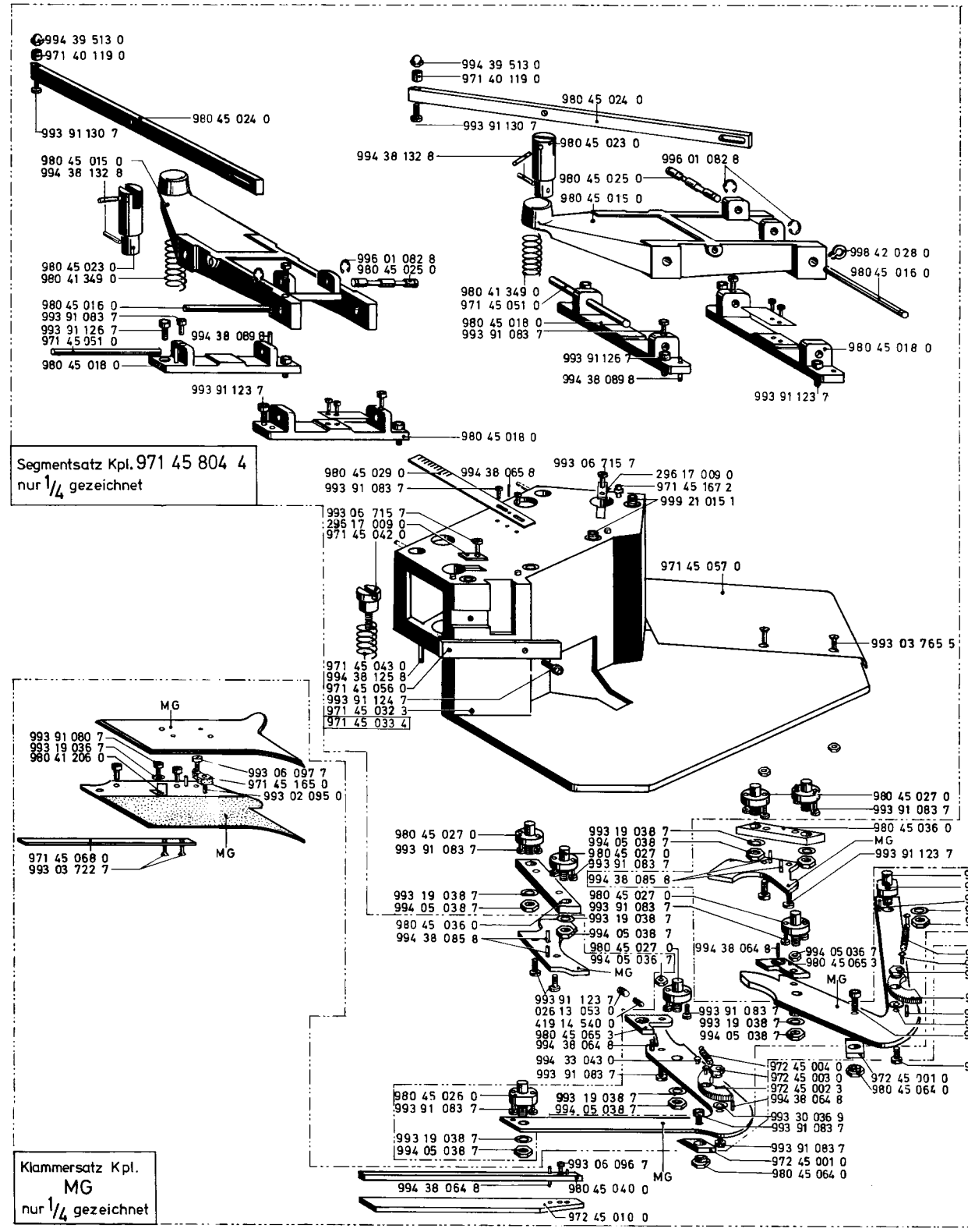

Segmentsatz Kpl. 971 45 804 4  
nur 1/4 gezeichnet

Klammersatz Kpl. MG  
nur 1/4 gezeichnet

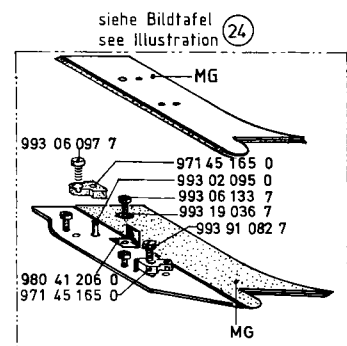



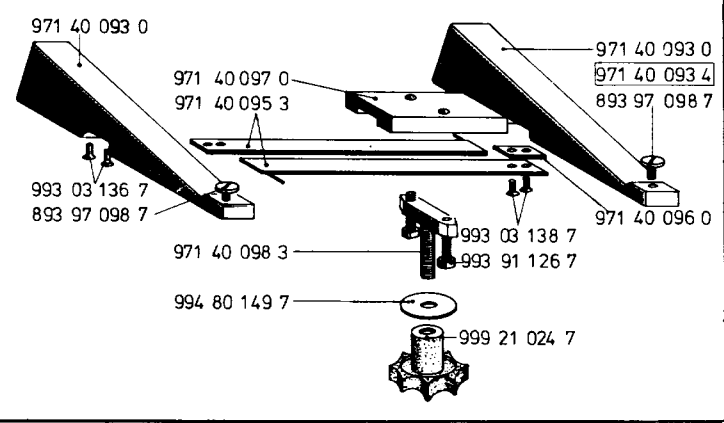
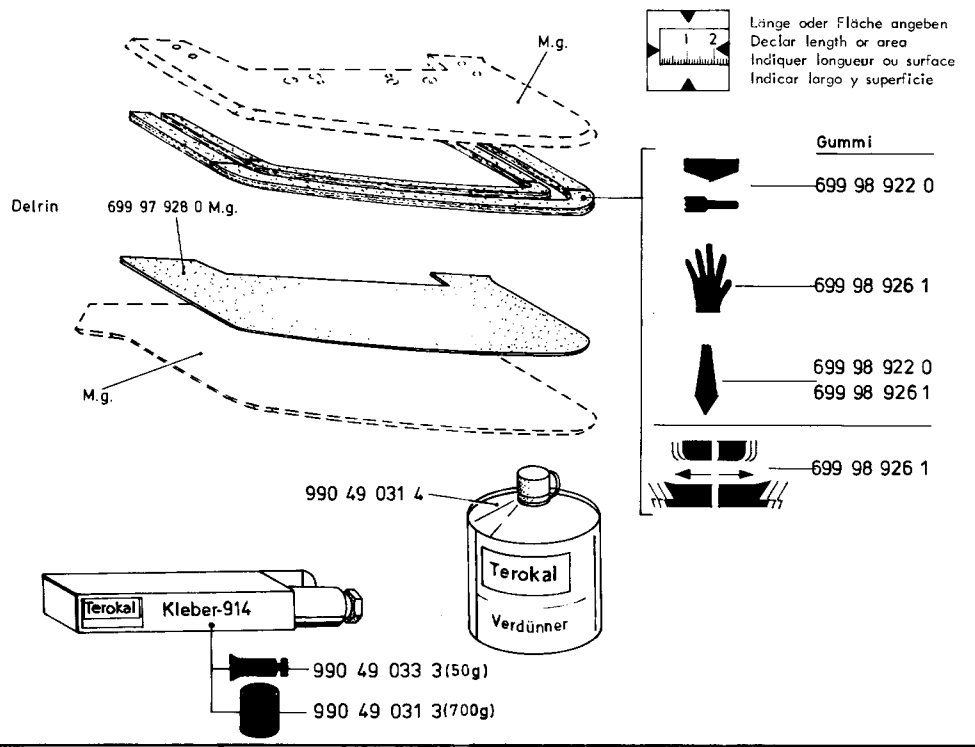
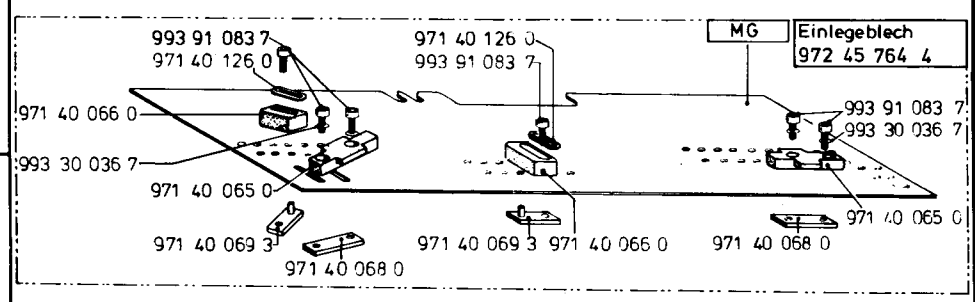
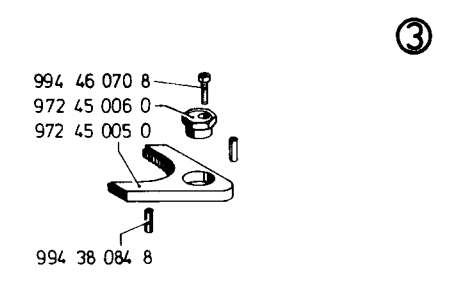
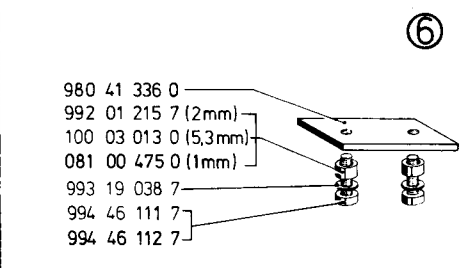
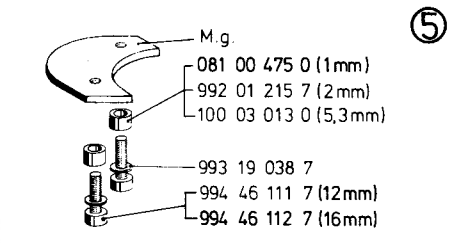
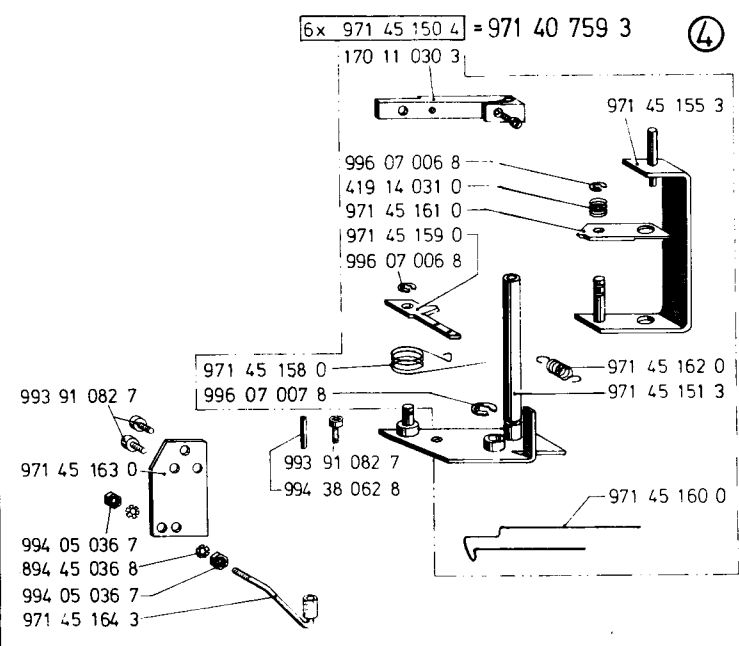
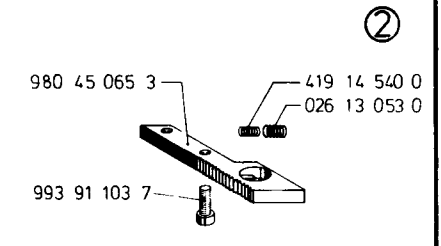
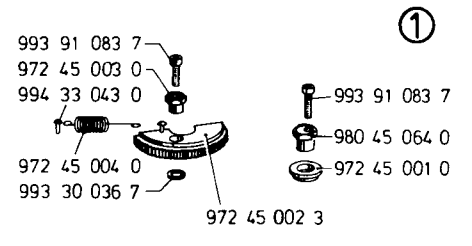
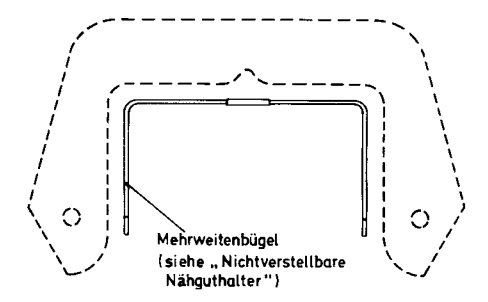
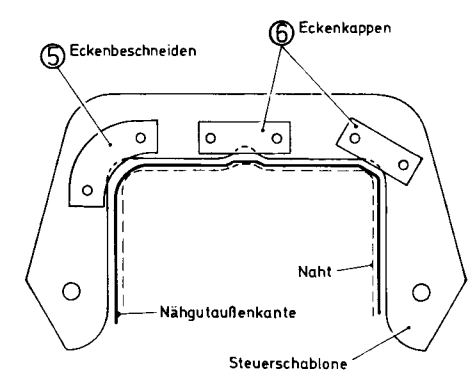
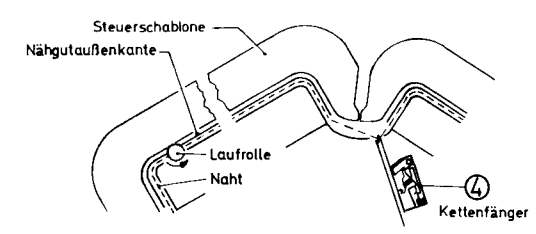
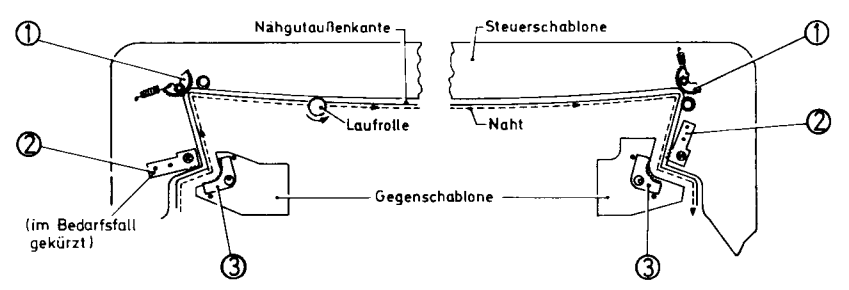





STapler		Länge	Breite	Stapeltiefe
ST 1/0 und ST1/1	Ablagefläche	300	165	170
ST 2/0 und ST2/1	Ablagefläche	500	165	155
ST 3/0 und ST3/1	Ablagefläche	300	240	170

971	ST-2/0(50Hz)
972	ST-2/1(60Hz)
971 42 752 4	(50Hz)
971 42 755 4	(60Hz)

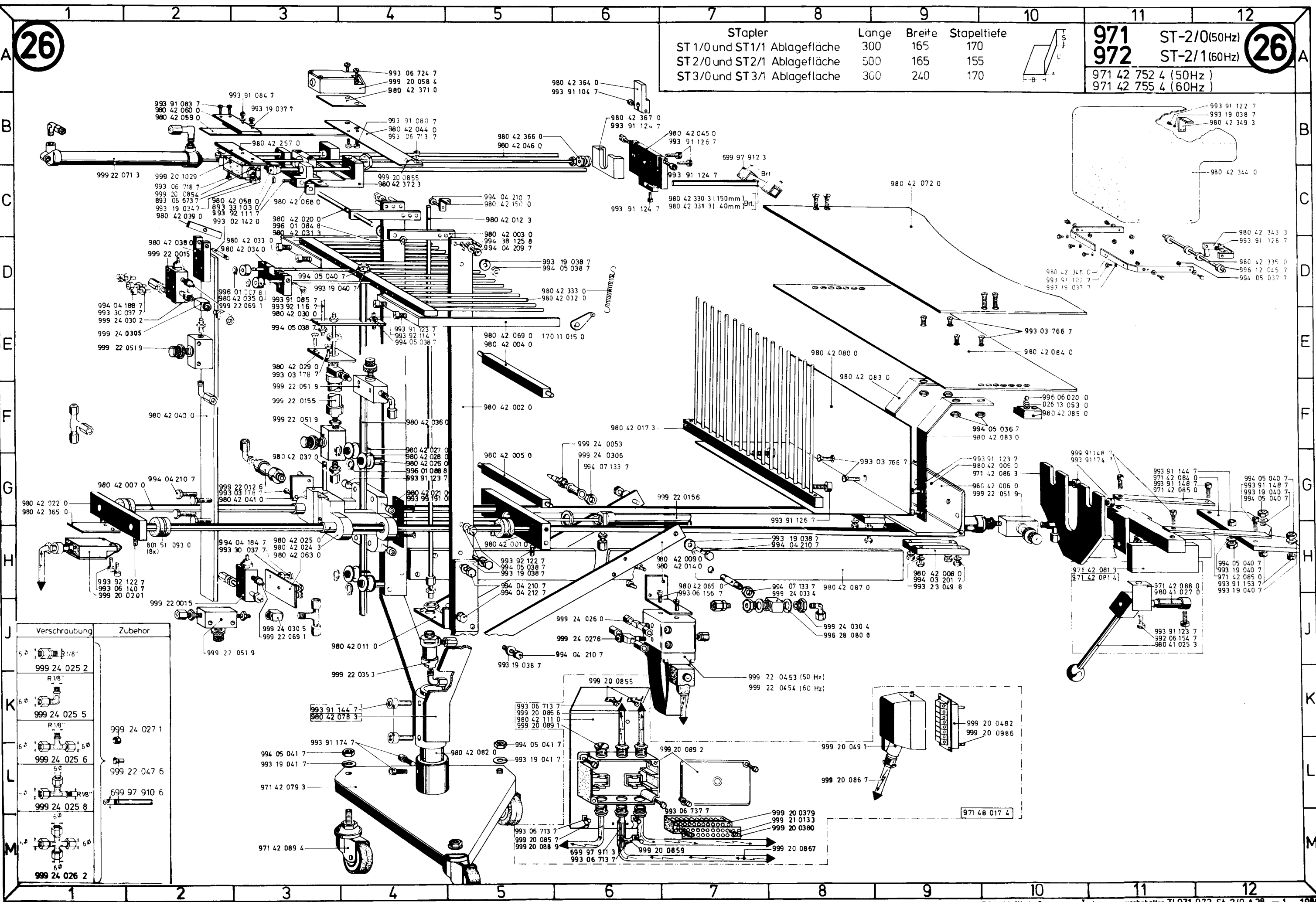

Verschraubung	Zubehör
5.2 R 1/8"	
999 24 025 2	
6.0 R 1/8"	
999 24 025 5	
6.2 R 1/8"	999 24 027 1
999 24 025 6	999 24 027 6
5.0 R 1/8"	699 97 910 6
999 24 025 8	
5.0 R 1/8"	
999 24 026 2	

STapler	Länge	Breite	Stapeltiefe
ST 1/0 und ST1/1 Ablagefläche	300	165	170
ST 2/0 und ST2/1 Ablagefläche	500	165	155
ST 3/0 und ST3/1 Ablagefläche	300	240	170

971 ST-3/0(50Hz)  
 972 ST-3/1(60Hz)  
 971 42 756 4 (50Hz)  
 971 42 757 4 (60Hz)

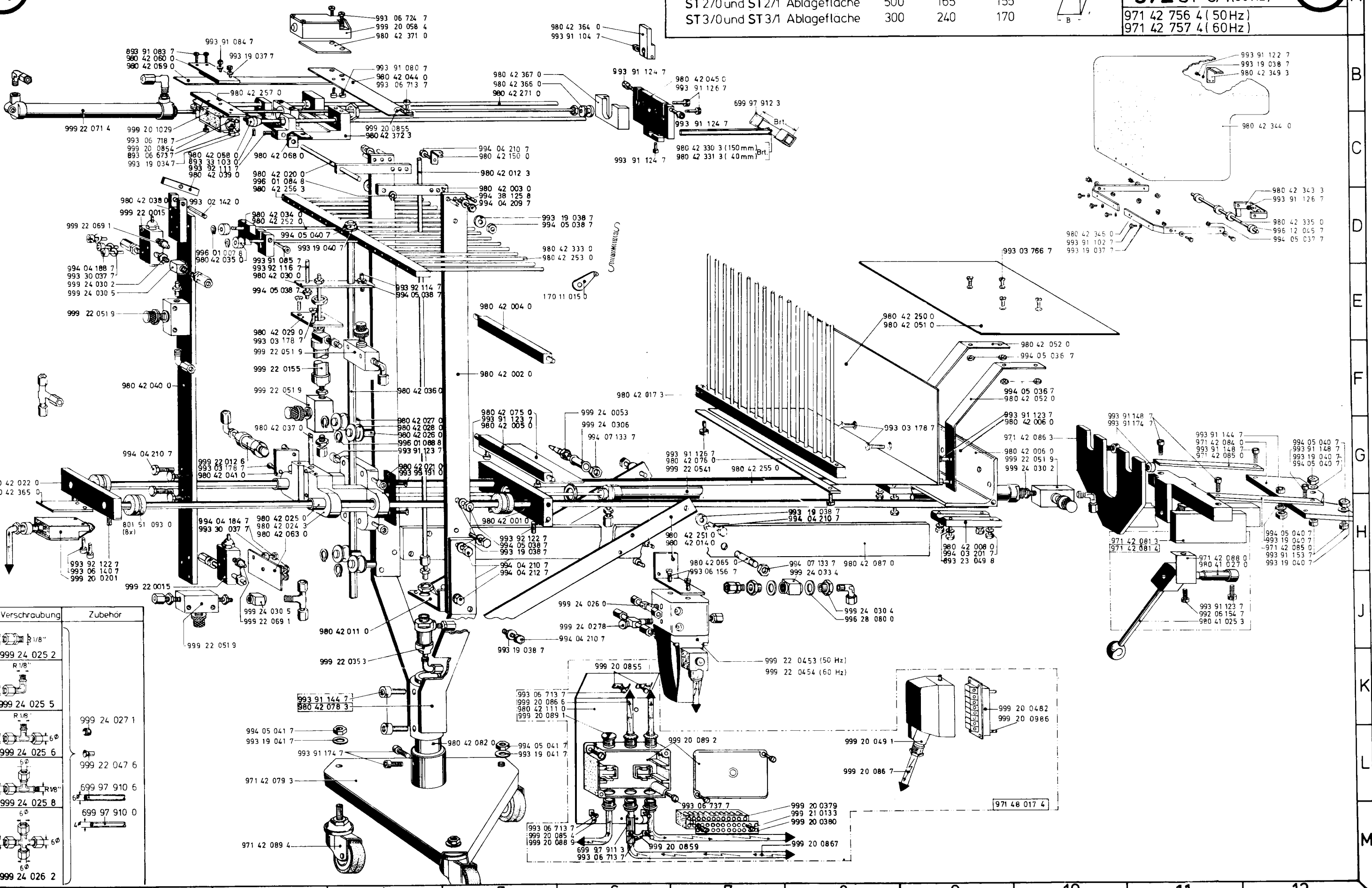

Verschraubung	Zubehör
6φ R1/8"	999 24 025 2
6φ R1/8"	999 24 025 5
6φ R1/8"	999 24 027 1
6φ R1/8"	999 24 025 6
5φ R1/8"	999 22 047 6
6φ R1/8"	699 97 910 6
6φ R1/8"	999 24 025 8
6φ R1/8"	699 97 910 0
6φ R1/8"	999 24 026 2







Ersatzteilliste. Spare parts. Pièces de rechange. Piezas de repuesto.

Teile-Nr.	Benennung	Teile-Nr.	Benennung	Teile-Nr.	Benennung	Teile-Nr.	Benennung	Teile-Nr.	Benennung	Teile-Nr.	Benennung
	KL.971/72	170 11 013 0	SPANNUNGSPLATTE 1F10	296 00 004 4	ARMWELLE 3B6	296 15 282 0	SPULE 2M1,13D7,13D2	396 10 027 3	GEGENGEWICHT 2C9	396 12 045 0	FADENOESE 1E2,2E2
		170 11 013 4	SPANNUNGSPLATTE 1F10	296 00 005 1	HINT.LAGERGEH. 3B6	296 16 031 0	ZUGFEDER 14B6	396 10 048 3	VERSCHLUSZSCHEIBE 1B11, 2B11,3D8	396 12 046 3	NADELSTG.BUCHSE 1E4
004 00 467 0	SCHLEIBE,ARBSCHLUSS 2964, 29H5,29L11	170 11 014 0	BOLZEN 1F10	296 00 007 0	LAGEGEH. 1C6,2C6,3D5	296 16 067 0	BUCHSE 1D8,1C8	396 10 049 0	SCHLEIBE 2C11,3D5	396 12 048 3	BUCHSE 2D3
004 02 012 0	GLEITSCHONER 8L8	170 11 015 0	FADENF.PLATTE 1F10,25E6, 26E6,27E6	296 00 008 0	ANLAGERING 1C6,2C6 2C10 3B6,3D8	296 16 114 0	ZUGFEDER 17A3	396 10 051 0	FADENHEBELSCHUTZ 2E9	396 12 067 4	NADELSTANGE KPL. 1E4,2E3
025 16 221 0	ZUGFEDER 29L6	170 11 020 0	DREHFEDER 1G8	296 00 009 0	SCHUTZGEHAEUSE 1B6,2B6, 3B6	296 17 009 0	BLATTFEDER 18G7,18E9, 19F9,19G7,20G7,20G9, 21F9,21G7,22F9,22G7	396 10 053 0	HALTEBLECH 2G4	396 15 281 4	GREIFER 2L2,2L5
026 13 053 0	DRUCKFEDER 20K9,21K9, K9 24D4,26F10	170 11 021 0	ANSATZSCHR. 1H9	296 00 010 0	SCHUTZGEHAEUSE 1B10,2C10	296 25 001 0	SCHUTZHAUBE 12E3,12L7, 13E3	396 10 055 0	LAGERGEHAEUSE 1C10,2C11, 3B8	396 17 006 0	HUELSE 2H1
026 14 043 0	GUMMIFUSS 8M3	170 11 022 0	DISTANZSCHEIBE 1G8	296 00 011 0	SCHUTZGEHAEUSE 1B10,2C10	296 31 080 0	KLOBEN 1D2,2C2	396 10 054 4	LAGERGEHAEUSE 1D10,2C11, 3B8	396 17 008 0	DRUCKFEDER 2H2
026 14 044 0	SCHLEIBE 8M3	170 11 023 3	FADENFUEHRUNG 1K6	296 00 012 0	SCHUTZGEHAEUSE 1B10,2C10	296 31 085 0	BOLZEN 1D2,2D2	396 10 074 4	VERTEILER 1A7	396 17 011 3	AUSLÖSEHEBEL 2G1
030 00 031 0	SCHLEIBE 1G10,1L2	170 11 028 3	HALTER 1L4	296 00 014 0	KONUSHUELSE 2B11,3C8	296 31 086 0	ZUGSTANGE 2B7	396 10 078 0	DRUCKFEDER 1D9	396 17 014 0	FEDER 2G2
040 00 202 0	SCHLEIBE 8A1,8A5,8M6	170 11 030 3	STELLKLEMME 1K4,24D6	296 00 018 0	FAD.REGULIERBUEGEL 2G7	296 31 086 3	ZUGSTANGE 1B8	396 10 088 0	FINGERSCHUTZ 2E5	396 17 015 4	SPULERVORSPANNUNG 2F7
053 00 035 0	SCHLEIBE 1F11,2G9	170 11 031 0	STELLWINKEL 1K5	296 00 033 0	OELDOCHT 2B3	296 31 095 0	OELDOCHT 1B8,2B9,4J3,4J7, 4J11	396 10 091 3	VENTILGEHAEUSE 1B6,2B6, 3B5	396 17 024 3	SPULERRAD 2H1
067 00 930 0	DRUCKFEDER 14G11	170 11 032 0	DREHFEDER 1L4	296 00 034 0	LENKERBOLZEN 2B3	296 31 096 0	OELSCHLAUCH 1D8,2D9,2E8	396 10 094 0	REGULIERSCHR. 1B5,2A6,3B5	396 17 025 3	SPULERARM 2H2
067 11 011 0	FUEHRUNGSROLLE 4L2	170 11 033 0	VERSCHLUSSKLOTZ 1M5	296 00 035 3	STELLRING 2B4	296 31 097 0	OELSCHLAUCH 1A8	396 11 002 0	FADENFUEHR.STIFT 1D8,2D7	396 17 026 0	SPULERACK 2H2
067 24 005 0	ACHSE 14L7	170 11 034 0	BLATTFEDER 1M5,18E6,18E10 19F6,19E6,20E6,20E10 21E6,21E10,23E7,23E9	296 00 040 0	NADELSTG.FUEHRUNG 2G7	296 31 098 0	STOPFEN 1D6	396 11 009 0	REGULIERSCHR. 1B5,2A6,3B5	396 17 028 3	AUSLÖSENOCKEN 2G1
067 32 015 0	DRUCKFEDER 2H2	170 11 035 0	RASTBOLZEN 1M5	296 00 041 0	GLEITSTEIN 1D4,2D4,3D4	296 33 003 3	HUBEXZENTER 1C7,2C7	396 11 019 4	GARNSTAENDER 11K4	396 17 033 3	SPULERWELLE 2G2
068 00 306 0	BUCHSE 17C16	170 11 036 0	FADENGABEL 1M6	296 00 048 0	ANLAUFSCHLEIBE 2C4	296 33 003 4	HUBEXZENTER 1C7,2C7	396 11 026 0	SPANNUNGSHUELSE 2F7	396 31 001 4	ZUGSTANGE 1B8,2B7
068 00 533 0	FADENF.SCHLEIBE 2G6	170 11 038 0	SPANNUNGSFEDER 1G4,1H2, 1F2	296 00 049 3	GEGENGEWICHT 1C9,3C6	296 33 029 0	BUCHSE 1C1,2C1	396 11 031 0	BUCHSE 2F7	396 31 003 0	EINSTELLSCHLEIBE 1D6,2E7
068 00 626 0	SCHLEIBE 14E8	170 12 004 3	NADELSTG.KLOBEN 1D3	296 00 050 0	DOCHT 1C2,2C2,3D2	296 35 029 0	BUCHSE 1C1,2C1	396 11 032 0	FADENOESE 2D3	396 31 009 0	OELSCHLAUCH 1E4
068 11 103 0	FADENSP.DRUCKFEDER 2G5	170 15 002 3	ZAHNRIEMENRAD 1L3	296 00 051 0	SCHLEIBE 2A3	296 37 010 020 3	ROHR 1A9	396 11 033 0	FADENFUEHRUNG 2G6	396 31 016 0	BUCHSE 1E2,2D2
068 33 023 0	DRUCKFEDER 4J3,4J7,4J11	170 15 004 0	WELLE 1L6	296 00 068 0	DICHTSCHLEIBE 1E9,1B8,1L7, 2E8,3E8	370 11 001 0	FADENFUEHRUNG 1E9	396 11 044 0	SCHLEIBE 2J1	396 31 017 0	REGULIERSCHR. 1B1,2B2
069 00 254 0	DRUCKFEDER 17M15	170 15 005 0	LAGERBUCHSE 1K6	296 00 069 0	OELFILZ 1C9,3C6	370 11 006 0	REGULIERBUEGEL 1E7	396 11 045 3	AUSLÖSESCHEIBE 2J2	396 31 026 0	DRUCKFEDER 1C2,2C2
077 11 022 0	AUFLAGE 11J3	170 15 006 0	SCHLEIBE 1L6	296 00 071 0	OELSCHLAUCH 1E9,1B8,1L7, 2E8,3E8	370 11 007 0	KLEMMSCHLEIBE 1E7	396 11 046 0	DRUCKFEDER 2K2	396 31 039 0	STOFFDRUECKERSTG. 2B2
077 11 023 0	ZENTRIERSTUECK 11J4, 12F11	170 15 007 3	FADENGEBER 1L4	296 00 101 0	OELDOCHT 1C5,2C5,3D4	370 11 010 4	FADENFUEHRUNG 1K6	396 11 047 0	DRUCKFEDER 2F7	396 31 045 4	LAGERBOCK 1B8,2B8
077 11 025 0	ABSCHL.STUECK 11G4	170 15 008 0	ZAHNFORMRIEMEN 1M6	296 00 112 0	OELDOCHT 1B11,2E10,3E9	370 11 011 0	DREHFEDER 1K4	396 11 048 0	BUCHSE 2K1	396 31 080 3	WINKELHEBEL 1D1,2C1
081 00 023 0	MUTTER 3E2,13F11	170 15 009 4	SCHWINGE 1K3	296 00 114 0	DROSSELRING 2E9,3E9	370 11 017 4	LEITBLECH 1H8	396 11 049 0	SPANNUNGSBOLZEN 2J1	396 31 082 3	WINKELHEBEL 1B3,2B2
081 00 099 0	DRUCKFEDER 29F6	170 15 023 4	STAUDECKEL 1J2	296 00 118 0	HUHLSCHEIN 1D10	370 12 001 0	NADELSTG.FUEHRG. 1D5	396 11 050 0	GARNNOLLENTELLER 11K3	396 31 083 0	EINSTELLKNOPF 1A3,2B2
081 00 118 0	SPANN.SCHLEIBE 1F7	170 15 024 0	SCHWINGE 1K3	296 00 119 0	HUHLSCHEIN 1D10	370 12 002 0	BLASROHR 1D2	396 11 051 3	SCHLEIBE 2J1	396 31 084 0	BOLZEN 1A2,2A2
081 00 475 0	SCHLEIBE 14J9,24D9,24G8	170 15 029 0	LAGERSCHILD 1H4	296 00 120 0	SCHLEIBE KUPFER 1E10	370 12 005 4	ARMWELLENKURBEL 1C4	396 11 052 3	AUSLÖSESCHEIBE 2J2	396 31 085 0	DRUCKFEDER 1B2,2A2
081 00 232 0	KLEMMSTUECKHUELSE 2G5	170 15 031 3	GEH.DECKEL 1H2	296 00 121 0	OELSCHLAUCH 1D10	370 15 001 0	SCHLEIBE 1K6,1K7	396 11 101 3	TRAEGER 11K4	396 31 086 4	KLOBEN 1D1,2D1
081 00 296 0	ZUGFEDER 17F3	170 15 033 0	GEH.DECKEL 1H1	296 00 125 0	DICHTSCHLEIBE 1B10	370 15 013 4	LAGERBUCHSE 1K6	396 11 102 3	FADENLEITARM 11H4	419 14 031 0	FEDER 24E6, 24F6
088 00 488 0	ZUGFEDER 1L1	170 15 040 0	DICHTUNG 1H2	296 00 131 3	OELINFUELLSCHR. 1A10	370 15 020 3	KURBELW.LAGER 1J4	396 11 103 0	FADENOESE 11H3	419 14 540 0	FEDER 20L9,21K9,22K9, 24D4
088 15 735 0	ZUGFEDER 17F4	170 25 001 0	INBUSSCHLUESSEL 12C5, 12C11	296 00 136 0	HIN.OELROHR 1B10	370 15 023 3	GURTRAD 1L6,1J5	396 11 104 0	GARNNOLLENTELLER 11K3	430 27 736 0	SCHLEIBE 20L5
091 00 213 0	ZAHNFORMRIEMEN 1L10,2D10, 2L10	171 15 017 0	WELLE 1K3	296 00 140 2	OELDOCHT 1B10,1L3, 2M7,4D3	371 15 001 0	SPREITZER 1K7,12D1,12D7	396 11 105 0	GARNR.STIFT 11J4	489 00 268 0	BOLZEN 2D6
095 00 402 0	FADENF.OESE 1E3	171 15 029 0	DICHTUNG 1H2	296 00 144 0	SCHLAUCHNIPPEN 1B10,1L3, 2M7,4D3	371 15 005 0	SPREIZENTRAEGER 1K7	396 11 106 3	GARNST.ROHR 11L4	489 00 269 3	BUCHSE 2D6
096 14 195 3	STELLRING 1L9	196 00 002 3	KOPFDECKEL 1E5,3E4	296 00 208 3	SPANNROLLENLAGER 1F11, 2G10	371 15 006 3	KLOBEN 1K6	396 11 107 0	GARNST.ROHR 11J4	489 00 273 3	SPANNUNGSSCHEIBE 2D6
097 00 335 0	LI.ZYL.SCHR. 1B5,2A4,3B3	196 00 006 0	HANDRAD 1D11,2D11,4L8	296 00 209 0	SPANNROLLENACHSE 1G11, 2G9	371 15 007 0	GEH.DECKEL 1J7	396 12 007 3	ARMWELLENKURBEL 1B3,2C5	504 11 008 0	STELLRING 17G4,17/164
099 00 494 0	FEDER 2D6	196 00 019 0	VERSCHL.SCHR.B. 1C4,2C3	296 00 201 0	SPANNROLLE 1F11,2F10	371 15 008 0	WINKEL 9D4	396 12 008 3	FADENHEBEL 2A4	504 31 110 0	STIRNRAD 23G2
100 03 012 3	KLOBEN 4F10	196 00 022 0	FADENFUEHRUNG 1F7	296 00 210 4	SPANNROLLE 1F11,2F10	371 15 010 4	KURBELWELLENLAGER 1J5	396 12 010 4	ARMWELLENKURBEL 1C4	699 99 158 5	DOCHT 2E5
100 03 013 0	DISTANZSCH. 24D9,24F8	196 00 029 0	STELLBUCHSE 2J1	296 00 211 3	ZAHNRIEMENRAD 1L10	371 15 011 4	ZUGSTANGE 1J4	396 12 017 3	FADENH.KURBEL 2B3	699 97 910 0	SCHLAUCH 2,5 LWx1 1A8, 1D9,1A6,4C1,4C5,4C9,25M2, 26M2,27M2
104 11 102 0	FADENSP.FEDER 1G10	196 00 042 4	NADELST.KLOBEN 2D3	296 00 212 3	ZAHNRIEMENRAD 1C10,2C9	371 15 015 3	KLEMMBOLZEN 1L2	396 12 024 0	FUEHRUNG 2D4,3D4	699 97 910 6	SCHL.4 LWx1 2L8,4B9, 4C10,4F11,,25L2,26L2, 27L2,29F3,29C7,29B7, 29C10,29C11,29D8,29J11
170 11 001 0	SPANNUNGSBLECH 1F6	196 00 043 3	NADELST. GELENK 2C4,3C4	296 00 213 3	ZAHNRIEMENRAD 1C10,2C9	371 15 016 4	GELENKWELLE 1L3	396 12 036 0	VENTILKOERPER 2B3	699 97 911 3	SCHL.13 LWx2 25M6,26M6, 27M6
170 11 001 4	SPANNUNGSBLECH 1G6	196 00 044 0	BUCHSE 1C4,2C3,3D2	296 00 214 0	ARMWELLE 1C8,2C8	371 15 026 0	FLANSCHLAGER 1G1	396 12 037 0	BUCHSE 1D2,2C2	699 97 912 3	SCHL.12 LWx2 25B7,26B7, 27B7
170 11 002 0	FUEHRG.DRAHT 1G6	196 00 047 0	FEDER 1C2,2C2,3D2	296 10 003 4	ARMWELLE 1D8,2C9	371 15 027 0	BUCHSE 1G1	396 12 038 0	VENTILKOERPER 1B3,2B3		
170 11 004 0	FADENGEBER 1G4	196 00 048 0	OELDOCHTWINKEL 3D4	296 10 003 0	ARMWELLE 1D8,2C9	371 15 028 4	DOPPELEXZENTER 1J4	396 12 039 3	VENTILSCHRABE 1B3,2B3		
170 11 005 0	SCHUTZBUEGEL 1E6	196 00 049 0	NADELLAGER 1C4,2C4,3C3	296 10 011 3	BEF.SCHR. 1B8,2B9,3B6	371 15 031 4	GREIFERGEHAEUSE 1H5,1G4	396 12 040 3	NADELSTANGE 1E4,2E3		
170 11 007 0	FUEHRUNGSBLECH 1F7	196 00 051 0	DICHTUNG 1D5,3E4	296 10 012 0	ARMWELLENST. 1C9,2C9,3B7	381 10 041 0	OELSTANDSAUGE 1J7				
170 11 008 0	TRAGSCHRAUBE 1E9	196 00 052 0	VERSCHL.STOPFEN 1B4,1D6	296 10 017 0	ARMDECKEL 2G1	381 10 042 0	DICHTUNGSRING 1J7				
		196 00 053 0	STIRNRAD 2M9	296 10 017 4	ARMDECKEL 2G1,2D9	381 10 043 0	OELABLASS SCHR. 1K7				
		296 00 003 0	ARMDECKEL 1C8,1D8,3D8	296 13 011 0	STOFFDR.FUEHRUNG 1E2,2D2	381 11 002 0	FADENF.PLATTE 1F10				
		296 00 004 0	ARMWELLE 1C8,1D8,3D8	296 13 016 0	TRAGSCHRAUBE 1B2,2B2	381 11 004 3	RAEDELNUTTER 1G10				
				296 15 001 0	LAGER 2F9,13L7	381 11 018 0	FADENSP.FEDER 1F10				

## Ersatzteilliste. Spare parts. Pièces de rechange. Piezas de repuesto.

Teile-Nr.	Benennung	Teile-Nr.	Benennung	Teile-Nr.	Benennung	Teile-Nr.	Benennung	Teile-Nr.	Benennung	Teile-Nr.	Benennung		
699 97 928 0	PL0 5x1100x1000 24J5			382		970 43 008 3	KEILRIEMENSCH. 5F7	971 40 002 3	STUETZSAEULE 8D10,15D8	971 40 086 0	EINLEGEBLECH MG 24H4	971 40 183 0	EINLEGEBLECH MG 24H4
699 97 941 6	SCHL.1 LWX0,5 2L6,2M7	893 96 077 0	FL.KOPFSCHR. M2,6X5 1J7			970 43 009 3	KEILRIEMENSCH. 5D10	971 40 003 0	ZENTRIERSCHRAUBE 8G9,	971 40 087 0	EINLEGEBLECH MG 24H4	971 40 184 0	EINLEGEBLECH MG 24H4
699 98 922	OGUMMI 24J8,24K8,24L8	893 96 094 0	FL.KOPFSCHR. M3X3			970 43 011 3	LAUFROLLE 5B8,6H9	971 40 004 0	ZENTRIERSTUECK 8G9	971 40 088 0	EINLEGEBLECH MG 24H4	971 40 185 0	EINLEGEBLECH MG 24H4
699 98 926 1	PL 3,0x1000x1000 24K8, 24J5	893 97 098 0	FL.KOPFSCHR. M4X8 3H9,			970 43 012 0	LAUFROLLE 6J9	971 40 005 0	DISTANZHUELSE 8C9,8C10	971 40 090 0	VENTILPLATTE 11M10	971 40 186 0	EINLEGEBLECH MG 24H4
699 99 158 0	OELDOCHT.RU.1,5 4F3,4F7, 4F11	893 97 098 7	FL.KOPFSCHR. M4X8 1K11, 2K11,884,24L2			970 43 013 0	KAEFIG 5C3,5D7	971 40 006 0	LAGERHUELSE 9L6	971 40 091 0	DISTANZSTUECK 9L3,11L11	971 40 189 2	EINLEGEBLECH MG 24H4
801 11 017 0	SPANNSCHR. 2K2	894 45 034 8	FAECHERSCH. IBE A3,2 1K8, 1L7,4E2			970 43 014 0	DECKEL 5D3,5E7	971 40 007 3	LAGERHUELSE 9L6	971 40 093 0	KONSOLE 8A3,24K2,24K4	971 40 190 0	EINLEGEBLECH MG 24H4
801 11 018 0	SCH. IBE 2K2	894 45 036 8	FAECHERSCH. IBE A4,3 1L7, 14L4,24G5			970 43 018 0	ZAHNROLLE 5A8,6F9,6G9	971 40 009 0	SCHALTFAHNE 9L6	971 40 093 4	KONSOLE 8A3,24K4	971 40 191 0	PLATTE 14C11
801 11 020 3	SPANNUNGSKNOPF 2J2	894 45 038 8	FAECHERSCH. IBE A6,4 2B7			970 43 019 0	LAUFROLLE 5A8,6G9	971 40 010 4	SCHALTFHNE 9L6	971 40 094 0	PLATTE 9J10	971 40 192 3	KLEMMSTUECK 14E8,14F11
801 11 021 0	FADENANZUGSFEDER 2J1	894 45 066 8	FAECHERSCH. IBE J4,3 1D8, 2C8			970 44 001 0	LAUFROLLE 6J9	971 40 011 0	DREHFEDER 9K6	971 40 095 3	LEISTE 8A3,24K3	971 40 193 0	WELLE 14F10
801 12 006 0	GELENKBOLZEN 2B38,29E7	894 45 136 8	STERNFEDER X230x9 14K2			970 44 002 0	LAUFROLLE 6J9	971 40 012 0	HALTER 11C10	971 40 096 0	DISTANZSTUECK 8B4,24L4	971 20 017 4	STICHPLATTE KPL. 1M3
801 40 063 0	DISTANZBUCHSE 17F17, 17H6,17/1H6	894 45 154 8	STERNFEDER 99X73x1,15 8H10			970 44 002 0	LAUFROLLE 6J9	971 40 013 0	STEBHOLZEN 8J12	971 40 097 0	FUEHRUNGSEINHEIT 8A3,24K3	971 25 750 3	NORM. ZUBEHOER 12A5
801 40 083 3	ABDECKPLATTE 8G1	894 45 154 8	STERNFEDER 99X73x1,15 8H10			971 01 001 3	TISCHPLATTE 8B6,15H8, 15H11	971 40 014 0	KABELHALTER 11J11	971 40 098 3	GEGENHALTER 8B3,24L3	971 25 551 3	NORM. ZUBEHOER 12A11
801 48 037 4	SCHUTZHAUBE 9L9,9K11	894 45 154 8	STERNFEDER 99X73x1,15 8H10			971 01 002 3	TISCHPLATTE 15H2,15H5	971 40 014 0	KABELHALTER 11J11	971 40 101 4	WARTUNGSEINHEIT 11C7	971 40 001 0	STAENDER 8F2
801 51 093 0	DAEMPFRING 25H2,26H2, 27H2	894 45 154 8	STERNFEDER 99X73x1,15 8H10			971 01 003 3	TISCHPLATTE 15H2	971 40 020 0	RASTERBLECH 8L5,9K2	971 40 102 4	LUEFTUNG 50 HZ 11K12	971 40 002 3	STUETZSAEULE 8D10,15D8
802 41 559 0	BOLZEN 14G11,14K11	894 45 154 8	STERNFEDER 99X73x1,15 8H10			971 01 004 3	TISCHPLATTE 15H8,15H11	971 40 021 0	WINKEL 9J3	971 40 102 4	LUEFTUNG 60 HZ 11K12	971 40 003 0	ZENTRIERSCHRAUBE 8G9,
802 51 199 0	GABELKOPF 17E2,	894 45 154 8	STERNFEDER 99X73x1,15 8H10			971 01 006 0	TISCHPLATTE 14C4	971 40 022 0	ANSTANDSSCH. IBE 8K5,8L5	971 40 104 4	REGELGETRIEBE 8K9	971 40 004 0	ZENTRIERSTUECK 8G9
893 02 143 0	ZYL. STIFT 1B1	894 45 154 8	STERNFEDER 99X73x1,15 8H10			971 10 001 0	OBERRARM 1G10	971 40 024 0	DRUCKFEDER 8L5	971 40 110 4	WARTUNGSEINHEIT 11D7	971 40 005 0	DISTANZHUELSE 8C9,8C10
893 03 041 0	SENKSCHR. 4E3,4E7,4E11, 4F3,4F7,4F11,12G10,13G10	894 45 154 8	STERNFEDER 99X73x1,15 8H10			971 10 001 4	OBERTeil KPL. 1H10	971 40 025 3	FUSSTRITT 8K7	971 40 111 3	ROHR 4E9	971 40 006 0	LAGERBOLZEN 9L6
893 03 722 6	SENKSCHR. 1G7	894 45 154 8	STERNFEDER 99X73x1,15 8H10			971 10 003 0	OELSTEIGROHR 1B10	971 40 026 0	SCHWENKBOLZEN 8H10	971 40 112 0	WINKEL 4G10	971 40 007 3	LAGERHUELSE 9L6
893 03 725 6	SENKSCHR. 1G7,14C8,14E8	894 45 154 8	STERNFEDER 99X73x1,15 8H10			971 10 004 0	OELSCHLAUCH 1D9	971 40 027 0	SPANNEBEL 8H10	971 40 113 0	BOLZEN 4G11	971 40 009 0	SCHALTFAHNE 9L6
893 03 765 6	SENKSCHR. 1G7,3J3	894 45 154 8	STERNFEDER 99X73x1,15 8H10			971 10 005 4	OELINFUELLSCHR. 1A10	971 40 028 0	RIEMENSPELLER 8H12	971 40 114 2	FUEHRUNG 15B10	971 40 010 4	SCHALTRING 9L6
893 03 765 7	SENKSCHR. 4G3,4G7,4G11	894 45 154 8	STERNFEDER 99X73x1,15 8H10			971 10 006 0	HOHLSCHR. 1E10	971 40 029 0	ANSCHLAGBOLZEN 8G9	971 40 114 4	FUEHRUNG 15B10	971 40 011 0	DREHFEDER 9K6
893 06 654 7	ZYL. SCHR. 11L6,19E6,19E9, 20E6,20E9,21E6,21E9, 23E7,23E9	894 45 154 8	STERNFEDER 99X73x1,15 8H10			971 10 008 0	SCHLAUCHWIPPEL 1D9	971 40 030 0	STUETZBOLZEN 8F2,8F7	971 40 115 0	AUSLOESERROHR 15G10	971 40 012 0	HALTER 11C10
893 06 672 6	ZYL. SCHR. M3X4 1F7	894 45 154 8	STERNFEDER 99X73x1,15 8H10			971 10 010 4	OELFALLROHR 1D10	971 40 031 0	AUFLAGEPLATTE 8F2	971 40 116 3	AUSLOESEBALKEN 15B10	971 40 013 0	STEBHOLZEN 8J12
893 06 673 7	ZYL. SCHR. M3X5 17M1,3 25C2,26C2,27C2	894 45 154 8	STERNFEDER 99X73x1,15 8H10			971 11 001 4	VEYSCHLUSSKLOTZ 1M5	971 40 034 3	TAEGER 8D4	971 40 118 0	BUCHSE 15B10	971 40 014 0	KABELHALTER 11J11
893 06 674 7	ZYL. SCHR. M3X6 1G4,1F1, 1H1,2F4	894 45 154 8	STERNFEDER 99X73x1,15 8H10			971 11 003 0	WINKEL 1K5	971 40 037 3	TAEGER 8D4,8D6	971 40 119 0	DISTANZBUCHSE 15B2,15C6, 18C6,18C8,18C6,18C8,19C6, 19C8,20C6,20C8,21C6,21C8, 22C6,22C8,23C7,23C9	971 40 015 0	STUETZBOLZEN 8M3
893 06 675 7	ZYL. SCHR. M3X8 1L8,1H1	894 45 154 8	STERNFEDER 99X73x1,15 8H10			971 11 003 0	WINKEL 1K5	971 40 041 0	STECKERHALTER 9E5	971 40 120 3	MOTORHALTER 8J10	971 40 016 0	WINKEL 8K3
893 06 714 7	ZYL. SCHR. M4X6 9J3	894 45 154 8	STERNFEDER 99X73x1,15 8H10			971 11 004 0	UNTERARM 1H10	971 40 042 0	ANSCHRAUBPLATTE 9J6,28L5	971 40 121 0	HALTERSCH. IBE 15C6	971 40 017 0	SPANNEBEL 8H10
893 06 715 7	ZYL. SCHR. M4X8 1H4	894 45 154 8	STERNFEDER 99X73x1,15 8H10			971 11 005 2	HALTER 1K7	971 40 044 0	AUSLOESERROHR 8M10,15G2, 15G8,15H6	971 40 122 0	VERBUNDPLATTE 15A6	971 40 018 3	SPANNEBEL 8H10
893 06 734 6	ZYL. SCHR. M5x6 1F9	894 45 154 8	STERNFEDER 99X73x1,15 8H10			971 11 006 0	VERSCHLUSSPLATTE 1G7	971 40 045 0	HALTERSCH. IBE 15C3	971 40 123 0	AUFHAENGEN 15B4	971 40 019 0	SPANNEBEL 8H10
893 06 736 7	ZYL. SCHR. M5x10 11M10, 28J4,29K6	894 45 154 8	STERNFEDER 99X73x1,15 8H10			971 11 007 0	WINKEL 1K5	971 40 046 3	ABDECKBLECH 8H7	971 40 124 0	BLASROHR 15B6	971 40 020 0	SCHWENKBOLZEN 8H10
893 06 738 7	ZYL. SCHR. M5x16 9E5	894 45 154 8	STERNFEDER 99X73x1,15 8H10			971 11 008 0	SCHLAUCHWIPPEL 1D9	971 40 047 3	ABDECKBLECH 8J5	971 40 126 0	SCH. IBE 24H1,24H2	971 40 021 0	WINKEL 9J3
893 08 556 0	HALBRD. SCHR. M3x10 1J2	894 45 154 8	STERNFEDER 99X73x1,15 8H10			971 11 009 0	ANTRIEBSWELLE 1M8	971 40 048 3	ABDECKBLECH 8H7	971 40 129 3	HALTER 9L6	971 40 022 0	ANSCHLAGBOLZEN 8G9
893 21 107 8	FEDERSCH. IBE 9C2	894 45 154 8	STERNFEDER 99X73x1,15 8H10			971 11 009 0	ANTRIEBSWELLE 1M8	971 40 049 0	MANSCHETTE 8C10	971 40 130 0	HUELSE 15B10	971 40 023 0	ANSTANDSSCH. IBE 8K5,8L5
893 23 047 8	FEDERSCH. IBE 107,2E7	894 45 154 8	STERNFEDER 99X73x1,15 8H10			971 11 010 0	DICHTUNG 1H7	971 40 050 0	STUETZE 4L8	971 40 131 0	SCHNECKE 5H6	971 40 024 0	DRUCKFEDER 8L5
893 23 048 8	FEDERSCH. IBE 2K2	894 45 154 8	STERNFEDER 99X73x1,15 8H10			971 11 011 3	NADELSCH. HALTER 1H5	971 40 051 0	MOTORWIPPE 8H10	971 40 132 0	SCHNECKE 5H6	971 40 025 3	FUSSTRITT 8K7
893 23 048 8	FEDERSCH. IBE 25H9,26H9, 27H9	894 45 154 8	STERNFEDER 99X73x1,15 8H10			971 11 012 0	PLATTE 1L8	971 40 052 0	ANSCHLAG 15B1,15D4	971 40 133 0	SCHWENKARMLAGER 8F8	971 40 026 0	SCHWENKBOLZEN 8H10
893 23 050 8	FEDERSCH. IBE 1M1	894 45 154 8	STERNFEDER 99X73x1,15 8H10			971 11 012 0	PLATTE 1L8	971 40 053 0	ANSCHLAG 24J1,24J4	971 40 134 0	SCHWENKARMLAGER 8F8	971 40 027 0	SPANNEBEL 8H10
893 23 087 8	FEDERSCH. IBE B6 28G7	894 45 154 8	STERNFEDER 99X73x1,15 8H10			971 11 013 0	LAGERBOLZEN 1K8	971 40 054 0	ANTRIEBSWELLE 8J10	971 40 135 0	SCHWENKARM 5H9	971 40 028 0	RIEMENSPELLER 8H12
893 30 036 9	SCH. IBE 4,3 20L10,20L11	894 45 154 8	STERNFEDER 99X73x1,15 8H10			971 11 014 3	OELFALLROHR 1D10	971 40 055 0	ANTRIEBSWELLE 8J10	971 40 136 0	GEMAEUSEARM 5H4	971 40 029 0	ANSCHLAGBOLZEN 8G9
893 33 103 0	GEW. STIFT M6X6 25C3, 26C3,27C3	894 45 154 8	STERNFEDER 99X73x1,15 8H10			971 11 014 3	OELFALLROHR 1D10	971 40 056 0	MOTORWIPPE 8H10	971 40 137 0	SPANNSCH. IBE 15B2,15C6, 18E3,23E4	971 40 030 0	STUETZBOLZEN 8F2,8F7
893 52 093 0	GEW. STIFT M4X4 1K6	894 45 154 8	STERNFEDER 99X73x1,15 8H10			971 11 015 0	VORD. NADELSCHUTZ 1G5	971 40 057 0	MOTORWIPPE 8H10	971 40 138 0	WINKEL 9J3	971 40 031 0	AUFLAGEPLATTE 8F2
893 52 105 0	GEW. STIFT M5X6 1B3,2C2,	894 45 154 8	STERNFEDER 99X73x1,15 8H10			971 11 015 0	VORD. NADELSCHUTZ 1G5	971 40 058 0	MANSCHETTE 8C10	971 40 139 0	BUEGEL 4F10	971 40 032 3	TAEGER 8D4
		894 45 154 8	STERNFEDER 99X73x1,15 8H10			971 11 016 3	GREIFERTRAEGER 1K6	971 40 059 0	STUETZE 4L8	971 40 140 0	WINKEL 9J3	971 40 033 3	TAEGER 8F6
		894 45 154 8	STERNFEDER 99X73x1,15 8H10			971 11 016 3	GREIFERTRAEGER 1K6	971 40 060 0	DISTANZROHR 15B1,15D4	971 40 141 0	WINKEL 9J3	971 40 034 3	TAEGER 8D4
		894 45 154 8	STERNFEDER 99X73x1,15 8H10			971 11 017 0	STICHPLATTE 1L1	971 40 061 0	ANSCHLAG 24J1,24J4	971 40 142 0	WINKEL 9J3	971 40 035 3	TAEGER 8F6
		894 45 154 8	STERNFEDER 99X73x1,15 8H10			971 11 017 0	STICHPLATTE 1L1	971 40 062 0	ANSCHLAG 24H1,24J3	971 40 143 0	WINKEL 9J3	971 40 036 0	ANSCHLAG 8D4,8D6
		894 45 154 8	STERNFEDER 99X73x1,15 8H10			971 11 018 0	STICHLÖCH. HALTER 1M3	971 40 063 0	GEWINDEPLATTE 24J2,24J4	971 40 144 0	WINKEL 9J3	971 40 037 3	TAEGER 8F6
		894 45 154 8	STERNFEDER 99X73x1,15 8H10			971 11 018 0	STICHLÖCH. HALTER 1M3	971 40 064 0	GEWINDEPLATTE 24J1,24J3	971 40 145 0	WINKEL 9J3	971 40 038 0	ANSCHLAG 8D4,8D6
		894 45 154 8	STERNFEDER 99X73x1,15 8H10			971 11 019 0	STICHLÖCH. HALTER 1M3	971 40 065 0	GEWINDEPLATTE 24J1,24J3	971 40 146 0	WINKEL 9J3	971 40 039 0	ANSCHLAG 8D4,8D6
		894 45 154 8	STERNFEDER 99X73x1,15 8H10			971 11 020 0	STICHLÖCH. HALTER 1M3	971 40 066 0	GEWINDEPLATTE 24J1,24J3	971 40 147 0	WINKEL 9J3	971 40 040 0	ANSCHLAG 8D4,8D6
		894 45 154 8	STERNFEDER 99X73x1,15 8H10			971 11 020 0	STICHLÖCH. HALTER 1M3	971 4					



## Ersatzteilliste. Spare parts. Pièces de rechange. Piezas de repuesto.

Teile-Nr.	Benennung	Teile-Nr.	Benennung	Teile-Nr.	Benennung	Teile-Nr.	Benennung	Teile-Nr.	Benennung	Teile-Nr.	Benennung
971 40 068 0	GEWINDEPLATTE 24J2,24J4	971 40 136 0	GEHAEUSEARM 5H4	971 40 231 3	LAGER 14H2	971 41 196 0	WINKEL 17/1C6	971 43 102 4	GEH.ARM 5B11	971 44 085 0	LAUFROLLE 6L9
971 40 069 3	GEWINDEPLATTE 24J1,24J3	971 40 137 0	SPANNSCHEIBE 15B6,15B2,18E3,23E4	971 40 232 3	WELLE 14K2	971 41 200 0	SPITZE 17/1F6	971 43 751 4	NAEHMASCHINE 1A11	971 44 086 0	OBERMESSE 4C1,4F3,4F7,4F11,12F9,13F9
971 40 075 0	EINLEGBLECH MG 24H4	971 40 139 0	BUEGEL 4F10	971 40 235 0	STELLRING 14K2	971 41 205 0	LASCHE 17/1E5	971 44 002 0	LAUFROLLE 6C9	971 44 087 0	UNTERMESSE 4D3,4F7,4E11,12G9,13G9
971 40 076 0	EINLEGBLECH MG 24H4	971 40 157 4	STEMPELSTANGE 3E2	971 40 237 0	AUSLEGER 14K3	971 41 206 0	LASCHE 17/1F6	971 44 003 0	LAUFROLLE 6C9	971 44 088 3	KEILRIEMENSCH. 6E1,6F1
971 40 077 0	EINLEGBLECH MG 24H4	971 40 175 0	EINLEGBLECH MG 24H4	971 40 238 0	PLATTE 14K3	971 41 863 4	NAEGUTHALTER 4C3,17A17	971 44 004 3	KEILRIEMENSCH. 6C2	971 44 089 3	KEILRIEMENSCH. 6F3
971 40 078 0	EINLEGBLECH MG 24H4	971 40 176 0	EINLEGBLECH MG 24H4	971 40 239 3	HEBEL 14F7	971 41 864 4	NAEGUTHALTER 4C3,17A5	971 44 005 3	KEILRIEMENSCH. 6C2	971 44 092 0	KLEMM 4D5,4D9
971 40 079 0	EINLEGBLECH MG 24H4	971 40 177 0	EINLEGBLECH MG 24H4	971 40 240 0	ABWEISER 14C9	971 41 866 4	NAEGUTHALTER 4C10,17A15	971 44 006 3	KEILRIEMENSCH. 5H7,6C3	971 44 120 0	DRUCKPLATTE 4G7
971 40 080 0	EINLEGBLECH MG 24H4	971 40 178 0	EINLEGBLECH MG 24H4	971 40 241 0	KLOBEN 14G7	971 42 050 3	BLINDSTECKER 9K7	971 44 007 0	BUCHSE 3C2	971 44 121 3	MESSERTRAEGER 4D7,4D11
971 40 081 0	EINLEGBLECH MG 24H4	971 40 179 0	EINLEGBLECH MG 24H4	971 40 242 0	HEBEL 14F7	971 42 079 3	STAENDERFUSS 25L3,26L3,27L3	971 44 008 0	BUCHSE 3B2	971 44 122 0	WINKEL 4D6
971 40 082 0	EINLEGBLECH MG 24H4	971 40 180 0	EINLEGBLECH MG 24H4	971 41 001 0	HALTER 16E3	971 42 081 3	FUEHRUNGSBOCK 25H11,26H11,27H11	971 44 009 3	LAUFROLLE 6E3	971 44 123 0	LEITSTUECK 4E5
971 40 083 0	EINLEGBLECH MG 24H4	971 40 181 0	EINLEGBLECH MG 24H4	971 41 003 0	DRUCKFEDER 16B6,16E3,16E10,16L2,16L6,16L10,17E2,17E16,17/1E2	971 42 081 4	FUEHRUNGSBOCK 25H11,26H11,27H11	971 44 012 0	FUEHRUNGSBUCHSE 4G3,4G7,4G11	971 44 124 3	BLASROHR 4E5,4E9
971 40 084 0	EINLEGBLECH MG 24H4	971 40 182 0	EINLEGBLECH MG 24H4	971 41 005 0	HALTER 16E5,17F14	971 42 084 0	PLATTE 25G11,26G11,27G11	971 44 013 0	MITNEHMER 3F2,4C6,4C10,4D3,12F10,13F10	971 44 125 0	VERSTAERKUNG 4E6
971 40 085 0	EINLEGBLECH MG 24H4	971 40 183 0	EINLEGBLECH MG 24H4	971 41 006 0	HALTER 16K6,16K10	971 42 085 0	VERBUNDSTANGE 25G11,26G11,2	971 44 014 0	UNTERMESSE (HSS) 4F2,4F3,4F7,4F11	971 44 126 0	LEITSTUECK 4F11
971 40 086 0	EINLEGBLECH MG 24H4	971 40 184 0	EINLEGBLECH MG 24H4	971 41 008 0	HALTER 16D10,16K2	971 42 086 3	STIRNPLATTE 25G10,26G10,27G10	971 44 015 3	MESSERTRAEGER 4E2,4E6,4E10	971 44 200 4	SCHERKOPF 4A3,4G4
971 40 087 0	EINLEGBLECH MG 24H4	971 40 185 0	EINLEGBLECH MG 24H4	971 41 032 0	SCHLUESSEL 16B2,16B6,16B9,16H2,16H6,16H10,17B2,17B14,17/1B2	971 42 088 0	WINKEL 25H11,26H11,27H11	971 44 016 3	MESSERTRAEGER 4E3	971 44 201 4	SCHERKOPF 4G12
971 40 088 0	EINLEGBLECH MG 24H4	971 40 186 0	EINLEGBLECH MG 24H4	971 41 060 4	NAEGUTHALTER 16F5	971 42 089 4	LENKROLLEKPL 25M3,26M3,27M3	971 44 018 0	MESSER (HSS) 4F11,4E7,4E3	971 44 751 4	BESCHNEIDER 3E11
971 40 090 0	VENTILPLATTE 11M10	971 40 189 2	EINLEGBLECH MG 24H4	971 41 061 4	NAEGUTHALTER 16F9	971 42 751 4	STAPLER ST-1/0 25A11	971 44 019 0	LEITSTUECK 4E2	971 45 025 3	BUCHSE 1B3
971 40 091 0	DISTANZSTUECK 9L3,11L11	971 40 190 0	EINLEGBLECH MG 24H4	971 41 062 4	NAEGUTHALTER 16M1	971 42 752 4	STAPLER ST-2/0 26A11	971 45 028 0	DECKEL 1B01	971 45 029 0	DISTANZROHR 1B1,23D2
971 40 093 0	KONSOLE 8A3,24K2,24K4	971 40 191 0	PLATTE 14C11	971 41 063 4	NAEGUTHALTER 17F14,17/1H1	971 42 754 4	STAPLER ST-1/0 25A11	971 45 031 3	HALTERSEGMENT 21H7	971 45 032 3	HALTERSEGMENT 19H7,20H7,22H7
971 40 094 0	PLATTE 9J10	971 40 192 3	KLEMMSTUECK 14E8,14F11	971 41 065 3	HEBEL 17B16	971 42 755 4	STAPLER ST-2/1 26A11	971 45 033 4	HALTERSEGMENT 22H7	971 45 042 0	ANSATZSCHRAUBE 9G7,1B02,18H7,20G7,21G7,23H8
971 40 095 3	LEISTE 8A3,24K3	971 40 193 0	WELLE 14F10	971 41 066 3	HEBEL 14B16	971 42 756 4	STAPLER ST-2/0 27A11	971 45 043 0	DRUCKFEDER 18H7,19H7,20H7,22H7,23H8	971 45 044 0	GELENKHEBEL 18D6,18D8,19D6,20D6,20D8,21D6,21D7,23D7,23D9
971 40 096 0	DISTANZSTUECK 8B4,24L4	971 40 194 3	SCHLITTEN 14G11	971 41 069 0	BUEGEL 17C15,17G1,17/1G1	971 43 001 0	STECKERHALTER 9E2	971 45 046 0	RASTBOLZEN 18D10,18E6,19D10,19E6,20D10,20E6,21D10,21E6,23E7,23E10	971 45 047 0	BRUECKE 18E6,18E9,19E6,19E9,20E6,20E9,21E6,21E8,23E7,23E9
971 40 097 0	FUEHRUNGSLEISTE 8A3,24K3	971 40 195 0	MESSERTRAEGER 14G11	971 41 070 0	KLOBEN 17C15	971 43 002 0	HALTBLECH 9C4	971 45 048 0	SPANNBRUECKE 18E7,18E9,19E7,19E8,20E7,20E9,21E7,21E8,23E7,23E9	971 45 048 0	SPANNBRUECKE 18E7,18E9,19E7,19E8,20E7,20E9,21E7,21E8,23E7,23E9
971 40 098 3	GEGENHALTER 8B3,24L3	971 40 196 0	MESSER 14E8	971 41 071 0	FEDER 17D16	971 43 003 0	LAUFROLLE 6F9	971 45 049 0	LAGERBOCK 18D9,18E6,21D9,21E6	971 45 050 0	HEBEL 18C9,18D7,21C7,21C9
971 40 101 4	WARTUNGSEINHEIT 11C7	971 40 197 0	ACHSE 16G11	971 41 072 0	FEDER 17D16	971 43 004 0	HALTBLECH 9C4	971 45 051 0	ACHSE 18F6,18F9,19F6,19F8,20F6,20F9,21F6,21F8,22E6,22E8	971 45 052 0	DISTANZROLLE 18F7,18F8,19E8,19F6,20E8,20F7,21E8,21F7
971 40 102 4	LUEFTUNG 50 HZ 11K12	971 40 198 0	LEISTE 14F11	971 41 076 0	SCHARNIER 17C14,17D3	971 43 005 0	LAUFROLLE 6F9	971 45 054 4	ZWISCHENPLATTE 18E8,19E8,20E7,20E9,21E7,21E8,23E8	971 45 055 4	ZWISCHENPLATTE 18E10,
971 40 104 4	REGELGETRIEBE 8H10	971 40 199 3	KLEMMSTUECK 14L8	971 41 076 4	SCHARNIER 17C14	971 43 008 0	FUEHRUNGSROLLE 5F7				
971 40 106 4	FUSSSTRIIT 8L7,9K6	971 40 200 0	LEISTE 14K11	971 41 081 4	NAEGUTHALTER 16L5	971 43 015 3	HEBEL 5D9,5E3,5F10				
971 40 107 4	LUEFTUNG 60 HZ 11K12	971 40 201 0	HALTER 14J9	971 41 082 4	NAEGUTHALTER 16M9	971 43 017 0	ROLLE 5D9,5E3,5F9				
971 40 109 4	REGELGETRIEBE 8K9	971 40 202 0	LEISTE 14D5,14E8	971 41 091 0	HALTER 17F14,17G1,17/1G1	971 43 019 0	SCHIEBE 5D9,5E4,5E10,5F4				
971 40 110 4	WARTUNGSEINHEIT 11D7	971 40 203 0	LAGER 14D8	971 41 092 0	DRUCKFEDER 17D2,17D14,17/1D2	971 43 020 0	DREHFEDER 5E10,5F5				
971 40 111 3	ROHR 4E9	971 40 204 0	WELLE 11F1,14G6	971 41 111 0	LAGER 17E3	971 43 021 0	DICHTPLATTE 5F4				
971 40 112 0	WINKEL 4G10	971 40 205 0	TRANSPORTRAD 14F6	971 41 117 0	FUEHRUNG 17E6	971 43 023 0	STREBE 11D5				
971 40 113 0	BOLZEN 4G11	971 40 206 3	HEBEL 14D8	971 41 118 0	PLATTE 17E6	971 43 026 0	SCHWENKARM 11C3				
971 40 114 2	FUEHRUNG 15B10	971 40 207 0	GLEITBLECH 14F5,14L8	971 41 119 0	MUTTER 17B3,17B5,17E3,17/1E3,17/1F5	971 43 027 0	ACHSE 5H11,11D7,11D5				
971 40 114 4	FUEHRUNG 15B10	971 40 208 0	BRUECKE 14D8	971 41 120 0	LEISTE 17B5,17/1B5	971 43 028 0	ACHSE 5K7				
971 40 115 0	AUSLUESERROHR 15G10	971 40 209 0	MESSER 14D8	971 41 121 0	LEISTE 17B5	971 43 031 0	GLEICHSTROMMAGNET 5B1,5B7				
971 40 116 3	AUSLUESERBALKEN 15B10	971 40 210 0	LEISTE 14C5,14D8	971 41 122 0	LEISTE 17B5	971 43 032 0	WELLE 5B1				
971 40 118 0	BUCHSE 15B10	971 40 211 0	PLATTE 14D5	971 41 123 3	HEBEL 17B3	971 43 033 0	WELLE 5B1				
971 40 119 0	DISTANZBUCHSE 15B6,15B2,18C6,18C8,18C6,18C8,19C6,19C8,20C6,20C8,21C6,21C8,22C6,22C8,23C7,23C9	971 40 212 0	PLATTE 14D8	971 41 124 0	AUFLAGEBOCK 17F2,17/1F2	971 43 034 0	LAGERBOLZEN 5D4,5E9				
971 40 120 3	MOTONHALTER 8J10	971 40 213 0	ACHSE 14C5	971 41 125 0	GLEITPLATTE 17F2	971 43 035 3	KEILRIEMENSCHIEBE 6C2				
971 40 121 0	HALTERSCHIEBE 15C6	971 40 214 0	ACHSE 14C5	971 41 126 0	HEBEL 17E2	971 43 036 0	SCHIEBE 5F11,5J8,5K11,5L7,11B2,11F2				
971 40 122 0	VERBUNDPLATTE 15A6	971 40 215 0	STANGE 14E5	971 41 127 0	GLEITPLATTE 17F2	971 43 037 0	HUELSE 5G11,5J7,11C2				
971 40 123 0	AUFHAENGER 15B4	971 40 216 0	ANSCHLAG 14F5	971 41 128 0	HEBEL 17E2	971 43 040 0	KLEMMRING 11B5,11F5				
971 40 126 0	SCHIEBE 24H1,24H2	971 40 217 0	PLATTE 14B8	971 41 129 0	EXZENTER 17D3	971 43 041 0	KLEMMHUELSE 11B5,11F5				
971 40 129 3	HALTER 9L6	971 40 218 0	ABWEISER 14C11	971 41 130 0	KLOBEN 17G1,17/1G1	971 43 044 0	HALTER 11K3				
971 40 130 0	HUELSE 15B10	971 40 219 3	HALTER 14M8	971 41 131 0	AUFNAHME 17K4,17/1K4	971 43 101 4	GEH.ARM 5B6				
971 40 131 0	SCHNECKE 5H6	971 40 220 3	TRAEGER 14G4	971 41 194 0	ANSATZMUTTER 17/1L4						
971 40 133 0	SCHWENKARMLAGER 8F8	971 40 221 0	PLATTE 14H5	971 41 195 0	SCHIEBE 17/1E5						
971 40 134 0	SCHWENKARMLAGER 8F8	971 40 222 3	KLEMMKLOBEN 14L3								
971 40 135 0	SCHWENKARM 5H9	971 40 223 0	KLEMMKLOBEN 14K6								
		971 40 230 3	ROLLE 14L7								

Ersatzteilleiste. Spare parts. Pièces de rechange. Piezas de repuesto.

Teile-Nr.	Benennung	Teile-Nr.	Benennung	Teile-Nr.	Benennung	Teile-Nr.	Benennung	Teile-Nr.	Benennung	Teile-Nr.	Benennung						
	19E10	971 45 804 4	SEGMENTSATZ	22F6	972 44 056 0	MESSER	29F6	972 44 121 0	LAGERBOLZEN	29A1,29G9	980 40 100 0	ARM	2H9	980 40 346 0	SCHALTLEISTE	11L12	
	20E10,21E10,23E10	971 46 075 0	SCHEIBE	17.1K4	972 44 059 0	WINKEL	28A5,28D5	972 44 122 0	SAEULE	29A3,29G12	980 40 100 1	ARM		980 40 350 3	ANTRIEBSRAD	8J10	
971 45 056 0	LEISTE	18H7,19H7,20H7, 21H7,22H7			972 44 060 0	GEN.STIFT	28A5	972 44 750 4	KETTFAEDNTR.KPA1-4	17G18	980 40 100 4	OBERTEITL.KPL.	2M2	980 40 351 0	KEILRIEMESCH.	8K10	
971 45 057 0	ABDECKBLECH	18G9,19G9, 20G9,21G9,22G9,23J9			972 44 061 0	GEN.STIFT	28A5	972 44 751 4	EINSCHNEIDEINR.	29A12	980 40 101 0	UNTERARM	2H9	980 40 352 0	KLEMMRING	8M10	
971 45 059 0	WELLE	20D10,20E8,21C10, 21E8,23D11,23E8			972 44 062 0	SCHEIBE	28J8	972 44 758 4	KETTFAEDNTR.KPA1-6	17G18	980 40 104 3	GREIFERWELLE	2L7	980 40 353 0	BOLZEN	8J9	
					972 44 063 0	DAEMPFSCHIBE	28J9,29E8	972 45 001 0	ROLLE	20M10,20L10,22L10, 22M10,24E2		980 40 105 0	VORLEGEWELLE	2L9	980 40 354 0	UMLAUFRAU	8J9
					972 44 064 0	GEWINDEPLATTE	14G5,29A3, 29E3,29B6,29F11,29K11	972 45 002 3	ZAHNSTUECK	14J6,20K11, 20L10,22K11,22L10,24E2		980 40 106 0	STEBBOLZEN	1K9,2K9,3H7	980 40 355 3	ZAHNRAD	8J10
971 45 068 0	VERB.LEISTE	18K6,19J6, 20J5,21J6,22J6,22H12			972 44 066 0	PASSCHR.	28E5,28H5,28H6	972 45 003 0	EXZENTERMUTTER	20K11, 20L10	980 40 107 0	STEBBOLZEN	1K8,2K8,3J7	980 40 360 3	REIBSCHEIBE	8H9	
971 45 081 3	TRAEGERPLATTE	23F5			972 44 070 3	SCHLITTEN	29H5	972 44 071 3	ANSCHLAG	29L5	980 40 109 0	MITTELTEILHALTER	2H5	980 40 363 0	RIEMEN SP.KLOBEN	8G12	
971 45 083 0	ZAHNRAD	23F4			972 44 076 0	WINKEL	28F8	972 44 077 0	FUEHRUNG	24E1	980 40 117 3	STIRNRAD	2L9	980 40 366 0	DRUCKRING	8H10	
971 45 084 0	ZUGSTANGE	23G2,23G5			972 44 074 0	SCHALTSTUECK	29K6	972 44 078 0	ANSCHLAGHUELSE	28F8	980 40 125 0	STICHPLATTE	2H6	980 40 366 3	DRUCKRING	8H10	
971 45 085 3	BUCHSE	23E3			972 44 075 0	SCHALTHEBEL	29L5	972 44 079 3	HALTER	18J2,28K7	980 40 128 0	WINKEL	9A4	980 40 367 3	KREUZLOCHMUTTER	8G10	
971 45 086 3	DECKEL	23D5			972 44 076 0	WINKEL	28F8	972 45 004 0	ZUGFEDER	20L10,22K11, 22L10	980 40 138 3	STELLRING	2L7,2L8,2R6	980 40 371 0	GEGENGEWICHT	8K10	
971 45 088 3	VERSCHIEBESTCK.	23G2, 23H6, 23J4			972 44 077 0	FUEHRUNG	28F8	972 45 005 0	ZAHNSTUECK	24F1	980 40 141 0	WINKEL	9C4	980 41 007 0	SCHARNIERSTIFT	16C2, 16C5, 16C9,16J6,16J10,16K2	
971 45 089 0	LEISTE	23J5,23K2			972 44 080 4	KETTFAEDNTRENNER	17L16	972 45 006 0	EXZENTER	24F1	980 40 147 3	MUELLBLASROHR	4/1B7	980 41 008 0	SCHENKELFEDER	16C2,16C5, 16C9,16J2,16J6,16J10	
971 45 091 3	HALTERSEGMENT	23G10			972 44 081 3	HALTBLECH	17L16	972 45 010 0	UEBERGANGSL.	18L9,19M9, 21M9,22M9,23L9	980 40 148 4	MUELLSCHLAUCH	4/1C7	980 41 025 3	SPANNKLOBEN	25J11,26J11	
971 45 092 1	LAGERBOCK	23F8,23F10			972 44 082 3	MESSERTRAEGER	17M13	972 45 751 4	VERST.NAEGUTHALTER	21B10	980 40 150 0	OBERRARM	3F7	980 41 027 0	EXZENTERBOLZEN	25H11, 26H11	
971 45 093 0	LAGERBOCK	23D7,23D8			972 44 083 3	ZUGSTANGE	17M15	972 45 754 4	VERST.NAEGUTHALTER	20B10	980 40 150 4	OBERTEILKLP	3G7	980 41 034 0	SCHARNIERSTUECK	16C2, 16C5,16C9,16J2,16J6,16J10	
971 45 094 0	HEBEL	23C9,23D7			972 44 084 0	WINKEL	17M13	972 45 764 4	EINLEGEBLECH	24H4	980 40 151 0	UNTERARM	3H7	980 41 035 0	SCHARNIERBOCK	16C2,16C5, 16C9,16J2,16J6,16J10	
971 45 095 0	ACHSE	23F7,23F9			972 44 085 0	MESSER	17M14	972 48 001 0	FLANSCH	10A7,10E7	980 40 154 0	STEMPEL	4B8,12E10,13E10	980 41 040 0	KONTAKTWINKEL	16F1,16F5, 16F9,16M1,16M5,16M9, 17F14,17J2,17J12	
971 45 096 0	SKALENLEISTE	23F8			972 44 086 0	MESSER	17M14	972 48 002 0	VERTEILERKASTEN	28F9	980 40 156 0	BUCHSE	3E2	980 41 206 0	ANSCHLAGWINKEL	16D4,16D7, 16D11,18F10,18J6,19G11, 19H6,20G11,20G5,21G11, 21H6,22G11,22H6	
971 45 150 4	KETTENFAENGER	24D6			972 44 087 0	MESSER	17M14	972 48 003 0	DECKEL	28F2	980 40 170 0	LAUFROLLE	6D9	980 41 321 0	LAGERBOCK	17C15,17G2, 17/1G2	
971 45 151 3	GRUNDPLATTE	24F7			972 44 088 0	AUSLÖSEHEBEL	17J17	973 00 049 0	STEBBOLZEN	5L2	980 40 171 0	LAUFROLLE	6D9	980 41 328 0	WELLE	17G4,17/1G4	
971 45 155 3	BUEGEL	24D7			972 44 089 0	GRUNDPLATTE	29G2	973 00 050 0	RIEMENSCHUTZ	5M1	980 40 173 0	LAUFROLLE	6E9	980 41 336 0	PLATTE	24F8	
971 45 158 0	DREHFEDER	24F6			972 44 090 3	GRUNDPLATTE	29M8	973 00 051 0	ZAHNROLLE	6H9	980 40 175 0	LAUFROLLE	6E9	980 41 349 0	DRUCKFEDER	16C5,16C9, 16D1, 16J5,16J9,16K1,17D2,17D4, 18E6,18E8,19E8,19E6,20E6, 20F8,21E6,21E8,22E6,22E8, 23E7,23E9,17/1D2	
971 45 159 0	HEBEL	24E6			972 44 091 4	HEBEL	29M8	973 00 052 0	ZAHNROLLE	6H9	980 40 176 0	LAUFROLLE	6E9	980 42 001 0	GLEITSTANGENLAGER	25H5, 26H,27H5	
971 45 160 0	FAENGER	24G7			972 44 092 3	HEBEL	29L9	973 00 053 0	LAGEBUCHSE	2K6	980 40 214 0	ZYLTRAERER	11L11	980 42 002 0	STEG	25E5,26E5,27E5	
971 45 161 0	KLINKE	24E6			972 44 093 3	HEBEL	29L9	973 00 054 0	ZAHNROLLE	6H9	980 40 218 0	DRUCKSCHEIBE	11M10	980 42 003 0	LAGERARM	25C5,26C5,27C5	
971 45 162 0	ZUGFEDER	24F7			972 44 094 3	HEBEL	29F3	973 00 055 0	ZAHNROLLE	6H9	980 40 319 0	OELTOPF	3E8	980 42 004 0	DISTANZSTUECK	25E5,26E5, 27E5	
971 45 163 0	PLATTE	24F5			972 44 095 0	ZUGSTANGE	29K9	973 00 056 0	ZAHNROLLE	6H9	980 40 320 0	OELROHR	2E9,3D8	980 42 005 0	DISTANZSTUECK	25G5,26G5, 27G5	
971 45 164 3	AUSLÖSEBUEGEL	24G5			972 44 096 0	ZUGSTANGE	29E4	973 00 057 0	ZAHNROLLE	6H9	980 40 321 0	DOCHT	2D9,3E8	980 42 006 0	ZWISCHENSTUECK	25G10, 26G10,27G10	
971 45 165 0	ANSCHLAG	19J7,20F12,20G11, 20J6,21F12,21G11,21J7, 22F11,22G11,22J7			972 44 097 0	ZUGSTANGE	29K9	973 00 058 0	ZAHNROLLE	6H9	980 40 322 0	OELSCHLAUCH	2E9,3E7	980 42 007 0	GLEITSTANGE	25G1,26G1	
971 45 167 2	AUFNAHMEBOLZEN	19F9,19G11, 20F9,22F9			972 44 100 0	SPITZENBESCHN.	29H12	973 00 059 0	ZAHNROLLE	6H9	980 40 344 0	HALTEWINKEL	11L12				
971 45 168 2	AUFNAHMEBOLZEN	21F9			972 44 101 0	SPITZENBESCHN.	29H12	973 00 060 0	ZAHNROLLE	6H9	980 40 345 0	SCHALTKLOBEN	11L12				
971 45 751 4	VERSTELLKOEPPER	18A4, 18G1			972 44 102 0	SPITZENBESCHN.	29C2	973 00 061 0	ZAHNROLLE	6H9							
971 45 752 4	VERST.NAEGUTHALTER	18A11,18L9			972 44 103 3	SPANNKLOBEN	29B1	973 00 062 0	ZAHNROLLE	6H9							
971 45 753 4	VERST.NAEGUTHALTER	19M9, 19A11,22B10			972 44 104 3	SPANNKLOBEN	29B1	973 00 063 0	ZAHNROLLE	6H9							
971 45 791 4	VERSTELLKOEPPER	23A5,23G5			972 44 105 0	SPANNKLOBEN	29B1	973 00 064 0	ZAHNROLLE	6H9							
971 45 792 4	VERST.NAEGUTHALTER	23A11, 23M10			972 44 106 3	PLATTE	29F5	973 00 065 0	ZAHNROLLE	6H9							
971 45 801 4	SEGMENTSATZ	21F7			972 44 107 3	SPANNKLOBEN	29F5	973 00 066 0	ZAHNROLLE	6H9							
971 45 802 4	SEGMENTSATZ	19F6,20F6			972 44 108 0	ECKENEINSCHNEIDER	29D6	973 00 067 0	ZAHNROLLE	6H9							
971 45 803 4	SEGMENTSATZ	23F8			972 44 108 4	ECKENEINSCHN.	29D6,29J6	973 00 068 0	ZAHNROLLE	6H9							
					972 44 109 0	OB.MESSERHALTER	29E7	973 00 069 0	ZAHNROLLE	6H9							
					972 44 109 0	OB.MESSERHALTER	29E7	973 00 070 0	ZAHNROLLE	6H9							
					972 44 110 3	GEWINDEPLATTE	29F5,29G5, 29J7,29L11	973 00 071 0	ZAHNROLLE	6H9							
					972 44 111 3	SPANNKLOBEN	29F1,29L1	973 00 072 0	ZAHNROLLE	6H9							
					972 44 112 0	BLASROHR	29F1,29M11	973 00 073 0	ZAHNROLLE	6H9							
					972 44 115 0	MESSER	29B1,29G10,29H10	973 00 074 0	ZAHNROLLE	6H9							
					972 44 116 0	LAGERBOCK	28K8	973 00 075 0	ZAHNROLLE	6H9							
					972 44 117 0	SCHALTERPLATTE	29J5	973 00 076 0	ZAHNROLLE	6H9							
					972 44 118 0	LAGER	29B2,29J10	973 00 077 0	ZAHNROLLE	6H9							
					972 44 119 0	UNTERM.HALTER	29C2,29H11	973 00 078 0	ZAHNROLLE	6H9							
					972 44 120 0	BLATTFEDER	29C4,29J12	973 00 079 0	ZAHNROLLE	6H9							

Ersatzteilliste. Spare parts. Pièces de rechange. Piezas de repuesto.

Teile-Nr.	Benennung	Teile-Nr.	Benennung	Teile-Nr.	Benennung	Teile-Nr.	Benennung	Teile-Nr.	Benennung	Teile-Nr.	Benennung
980 42 008 0	KLEMMSTUECK 25H9	980 42 072 0	LEITBLECH 26C9	980 44 025 0	WINKELHEBEL 17K16,17L16	980 45 064 0	EXZENTERMUTTER 20L10, 20M10,22L10,22M10,24E2	990 81 006 1	SCHRAUBENZIEHER 12R3; 12R9; 13B4;13B9	992 00 713 7	L.I.ZYL.SCHR. 167
980 42 009 0	STREBE 25H7,26H7	980 42 075 0	AUFLAGELEISTE 25F5,27F5	980 44 026 3	PLATTE 17K16	980 45 065 3	WECHSELSTUECK 20K10, 20L9,21K10,21L9,22K10,22L9, 24D3	990 81 006 2	SCHRAUBENZIEHER 12B3;12B9 13R4;13B9	992 00 719 0	L.I.ZYL.SCHR. 1E9
980 42 011 0	WINKEL 25J4,26J4,27J4	980 42 076 0	KLEMMLEISTE 25G7,27G7	980 44 027 0	SCHEIBE 27K16	980 45 066 0	EXZENTERMUTTER 20L10, 20M10,22L10,22M10,24E2	990 81 006 7	HYDRAULIK-OEL 12F6;12H11; 13F6;13H12	992 00 719 7	L.I.ZYL.SCHR. 2F7
980 42 012 3	STROESSEL 25C5,26C5,27C5	980 42 078 3	TRAEGER 25K3,26K3,27K3	980 44 032 0	SEITENMAND 17K13	980 45 067 0	EXZENTERMUTTER 20L10, 20M10,22L10,22M10,24E2	990 81 007 8	SORTIMENTKASTEN 12E1,12E7, 13E1,13E7	992 00 720 0	GEW.STIFT 2F7
980 42 014 0	VENTILWINKEL 25H7,26H7, 27H7	980 42 080 0	NAEHGUTABLAGE 26E8	980 44 033 0	ZUGFEUER 4G6,17L16	980 45 068 0	EXZENTERMUTTER 20L10, 20M10,22L10,22M10,24E2	990 81 008 4	SATZ.M.SCHLUESSEL 12D6, 12D12,12D6,13D12	992 00 859 0	ZYL.KOPFSCHR. 1B8,2B9,3B7
980 42 017 3	ABSTREIFER KPL. 25F6, 26F6,27F6	980 42 082 0	STAENDERROHR 25L5,26L5, 27L5	980 44 034 0	LAGERBOCK 17H18	980 45 069 0	EXZENTERMUTTER 20L10, 20M10,22L10,22M10,24E2	990 81 009 1	NAEHWIRN 1M1, 1M1,12J7, 13J2,13J7	992 01 064 0	ZYL.SCHR. 1K5
980 42 020 0	WELLE 25C3,26C3,27C3	980 42 083 0	GLEITBLECHHALTER 26E8, 26F10	980 44 035 0	WELLE 17H16	980 45 070 0	EXZENTERMUTTER 20L10, 20M10,22L10,22M10,24E2	990 81 010 1	OEL.F.OELARLAUF.25GR 12C2; 12C8;13C2;13C8	992 01 215 7	SCHEIBE 24D9,24F8
980 42 021 0	AUSGLEICHSTUECK 25E4, 26G4,27G4	980 42 084 0	ZWISCHENPLATTE 26E10	980 44 036 0	AUSLOESEHEBEL 17H17	980 45 071 0	EXZENTERMUTTER 20L10, 20M10,22L10,22M10,24E2	990 81 010 8	SORTIMENTKASTEN 12E1,12E7, 13E1,13E7	992 01 243 0	GEWINDESTIFT 1M9,1D5, 2G10
980 42 022 0	HILFSLAGER 25G1,26G1, 27G1	980 42 085 0	KLEMMSTUECK 26F10	980 44 037 0	FUEHRUNGSBOLZEN 17H16, 17J17	980 45 072 0	FUEHRUNGSSTUECK 18H2, 23J1,3B10,5H8	990 81 007 8	SORTIMENTKASTEN 12E1,12E7, 13E1,13E7	992 01 324 7	L.I.SENKSCHR. 8A1,8A5
980 42 024 3	LAGERBUCK 25H3,26H3,27H3	980 42 087 0	PLATTE 25H8,26H8,27H8	980 44 038 0	LEISTE 17K13	980 45 073 0	FUEHRUNGSSTUECK 18H2, 23J1,3B10,5H8	990 81 008 3	ZUBEHOERTASCHE 12J1,12J7, 13J2,13J7	992 01 341 7	RAEDELSCCHR. 2L8
980 42 026 0	BOLZEN 25G4,26G4,27G4	980 42 111 0	DECKBLECH 25K5,26K5,27K5	980 44 039 0	LEISTE 17K13	980 45 074 0	FUEHRUNGSSTUECK 18H2, 23J1,3B10,5H8	990 81 008 8	SATZ.M.SCHLUESSEL 12D6, 12D12,12D6,13D12	992 01 346 0	GEW.STIFT 2L8
980 42 027 0	EXZENTERBOLZEN 25G4, 26E4,27E4	980 42 150 0	ANSCHLAG 25C5,26C5,27C5	980 44 040 0	ZYLINDERTRAEGER 17K13	980 45 075 0	FUEHRUNGSSTUECK 18H2, 23J1,3B10,5H8	990 81 008 5	SATZ 1.SCHLUESSEL 12D4, 12D10,13E4,13E10	992 01 362 0	GEW.STIFT 2L9
980 42 028 0	ROLLE 25G4,26G4,27G4	980 42 250 0	NAEHGUTABLAGE 27E9	980 45 004 0	RITZEL 18E1,23E3	980 45 076 0	FUEHRUNGSSTUECK 18H2, 23J1,3B10,5H8	990 81 009 1	NAEHWIRN 1M1, 1M1,12J7, 13J2,13J7	992 01 368 7	STIFT 1,80X28,8 2J1
980 42 029 0	ZYLINDERKLOBEN 25C3,26C3, 27E3	980 42 251 0	STREBE 27H7	980 45 005 0	ZAHNRAD 18F1	980 45 077 0	ZUGSTANGE 18F1,18F4,18G1	990 81 010 5	KEILRIEMEN 6X850 5E8,5F7	992 01 393 7	6KT.MUTTER 1F7
980 42 030 0	FUEHRUNGSPLATTE 25E3, 26E3,27E3	980 42 252 0	AUFLAGELEISTE 27G3	980 45 006 0	ZUGSTANGE 18F1,18F4,18G1	980 45 078 0	ZUGSTANGE 18F1,18F4,18G1	990 81 010 8	SATZ 1.SCHLUESSEL 12D4, 12D10,13E4,13E10	992 01 449 7	GEGENMUTTER 992 01 491 0
980 42 031 3	AUFLAGELEISTE 25C3,26C3	980 42 253 0	AUFLAGESTAB 27G3	980 45 007 0	BOLZEN 23F4	980 45 079 0	SCHALTWINKEL 18J3,23J2, 23J4	990 81 010 1	OEL.F.OELARLAUF.25GR 12C2; 12C8;13C2;13C8	992 01 497 0	GEW.STIFT 3C10
980 42 032 0	AUFLAGESTAB 26D6,25E5	980 42 254 0	FUEHRUNGSSTANGE 27B5	980 45 013 0	LEISTE 18H3	980 45 080 0	LAGERBOCK 17C14,18F6, 18F9,19F6,20F6,20F9,21F6, 21F9,22E6,22E8,22E10,22F8	990 81 011 8	SORTIMENTKASTEN 12E1,12E7, 13E1,13E7	992 01 538 0	6KT.MUTTER 2G5
980 42 033 0	AUFLAGESTAB 26D3,25D3	980 42 330 3	GREIFER 25C7,26C7,27C7	980 45 015 0	GELENKHEBEL 22D9,22D6	980 45 081 0	LAGERBOCK 19D9,19E6, 20D9,20E6,22D9,22F6	990 81 012 8	NADEL 134 CF 80 13A7	992 01 727 7	6KT.MUTTER 3D9
980 42 034 0	LAGERPLATTE 25D3,26D3, 27D3	980 42 331 3	GREIFER 25C7,26C7,27C7	980 45 016 0	WELLE 17C14,17F3,22E6, 22E10,171F3	980 45 082 0	LAGERBOCK 19D9,19E6, 20D9,20E6,22D9,22F6	990 81 012 9	NADEL 134 CF 90 13A7	992 01 728 0	L.I.ZYL.SCHR. 105,2C5
980 42 035 0	ROLLE 25D3,26D3,27D3	980 42 333 0	FEDER 25D6,26D6,27D6	980 45 018 0	LAGERBOCK 17C14,18F6, 18F9,19F6,20F6,20F9,21F6, 21F9,22E6,22E8,22E10,22F8	980 45 083 0	LAGERBOCK 19D9,19E6, 20D9,20E6,22D9,22F6	990 81 013 1	NADEL 134 CF 100 13A7	992 01 815 0	SENKSCHR. 167
980 42 036 0	SAEULE 25F4,26F4,27F4	980 42 334 0	ROHR 25D12,26D12,27D12	980 45 019 0	LAGERBOCK 19D9,19E6, 20D9,20E6,22D9,22F6	980 45 084 0	HEBEL 19C9,19D7,20C9, 20D7,22C9,22D7	990 81 013 2	NADEL 134 CF 110 13A7	992 01 858 0	ZYL.STIFT 992 01 944 0
980 42 037 0	STOESSEL 25G3,26G3,27G3	980 42 343 3	HALTER 26C12,25D12,27D12	980 45 023 0	LAGERBOCK 19D9,19E6, 20D9,20E6,22D9,22F6	980 45 085 0	HEBEL 19C9,19D7,20C9, 20D7,22C9,22D7	990 81 013 3	NADEL 971 B1 CF 80 13A7	992 01 985 6	L.I.ZYL.SCHR. 2K2
980 42 038 0	LAGEH 25D2,26D2,27D2	980 42 344 0	SCHUTZHAUBE 25C12,26C12, 27C12	980 45 024 0	HEBEL 19C9,19D7,20C9, 20D7,22C9,22D7	980 45 086 0	HEBEL 19C9,19D7,20C9, 20D7,22C9,22D7	990 81 013 4	NADEL 971 B1 CF 90 13A7	992 02 081 0	STIFT 4E6
980 42 039 0	HEBEL 25C3,26C2,27C3	980 42 346 0	RAHMEN 25D10,26D10,27D10	980 45 025 0	STIFT 18E8,18D10,19E8, 19D10,22E8,22D9	980 45 087 0	AUFNAHME 18H10,18J8, 19J11,19L8,20J11,20L8,21J11, 21L8,22J11,22L8,23J9,23L11	990 81 013 5	NADEL 971 B1 CF 100 13A7	992 02 082 0	STIFT 992 02 095 0
980 42 040 0	FUEHRUNGSLEISTE 25F2, 26F2,27F2	980 42 347 0	WINKEL 25B12,26B12,27B12	980 45 026 0	AUFNAHME 18H10,18J8, 19J11,19L8,20J11,20L8,21J11, 21L8,22J11,22L8,23J9,23L11	980 45 088 0	AUFNAHME 16F2,16F6,17F15, 18J9,18J10,19J8,19J10, 19K9,20J8,20J9,20K9,21J8, 21J9,21J10,21K9,22J8,22J9, 22J10,22K9,23J10,23J11	990 81 013 6	NADEL 971 B1 CF 110 13A7	992 02 121 0	ZYL.STIFT M6x24 564
980 42 041 0	ZYLINDERKLOBEN 25G3, 26G3,27G3	980 42 348 0	WINKEL 25B12,26B12,27B12	980 45 027 0	AUFNAHME 16F2,16F6,17F15, 18J9,18J10,19J8,19J10, 19K9,20J8,20J9,20K9,21J8, 21J9,21J10,21K9,22J8,22J9, 22J10,22K9,23J10,23J11	980 45 089 0	SKALENLEISTE 18F8,19F7, 20F7,21F8,22F7	990 81 013 7	NADEL 971 B1 CF 110 13A7	992 02 122 0	ZYL.STIFT M6x50 17H15
980 42 044 0	KABELHALTER 25B4,26B4, 27B4	980 42 349 3	WINKEL 25B12,26B12,27B12	980 45 028 0	BOLZEN 18E1,18E4,18F1, 18F4,23G1,23H6,23K4	980 45 090 0	SKALENLEISTE 18F8,19F7, 20F7,21F8,22F7	990 81 013 8	NADEL 971 B1 CF 110 13A7	992 02 123 0	ZYL.STIFT 25D3,26C3,27D3
980 42 045 0	KLEMMPLATTE 25B7,26B7, 27B7	980 42 364 0	KLOBEN 25A6,26A6,27A6	980 45 029 0	SKALENLEISTE 18F8,19F7, 20F7,21F8,22F7	980 45 091 0	SKALENLEISTE 18F8,19F7, 20F7,21F8,22F7	990 81 013 9	NADEL 971 B1 CF 110 13A7	992 02 313 0	ZYL.SCHR. 2F4
980 42 046 0	FUEHRUNGSSTANGE 25B5, 26B5	980 42 365 0	PLATTE 25G1,26G1,27G1	980 45 030 0	SKALENFUEHRUNG 18C4,23C2	980 45 092 0	SKALENFUEHRUNG 18C4,23C2	990 81 014 0	NADEL 971 B1 CF 110 13A7	992 02 352 0	ZYL.SCHR. 2L7
980 42 051 0	GLEITBLECH 25E9	980 42 366 0	VERBINDUNGSSTCK. 25B5, 26B5,27B5	980 45 031 3	AUSLOESEBALKEN 15B9	980 45 093 0	SKALENFUEHRUNG 18C4,23C2	990 81 014 1	NADEL 971 B1 CF 110 13A7	992 02 403 0	ZYL.SCHR. 2E3,12H10
980 42 052 0	GLEITBL.HALTER 25F10, 27F10	980 42 367 0	MITNEHMER 25B6,26B6,27B5	980 45 032 2	SCHLUESSEL 15C2	980 45 094 0	SKALENFUEHRUNG 18C4,23C2	990 81 014 2	NADEL 971 B1 CF 110 13A7	992 02 404 0	ZYL.SCHR. 2E3,12H10
980 42 053 0	NAEHGUTABLAGE 25E9	980 42 371 0	PLATTE 25A4,26A4,27A4	980 45 033 2	SCHLUESSEL 18C2,23B3	980 45 095 0	SKALENFUEHRUNG 18C4,23C2	990 81 014 3	NADEL 971 B1 CF 110 13A7	992 02 427 7	ZYL.SCHR. 3D8
980 42 058 0	SCHALTNocken 25C3,26C3, 27C3	980 42 372 3	SCHMENKLAGER 25C4,26C4, 27C4	980 45 034 2	SCHLUESSEL 15C2	980 45 096 0	SKALENFUEHRUNG 18C4,23C2	990 81 014 4	NADEL 971 B1 CF 110 13A7	992 02 431 7	ZYL.SCHR. 3E4
980 42 059 0	LEISTE 25B2,26B2,27B2	980 43 004 0	GEHAEUSEKAPPE 986	980 45 035 2	SCHLUESSEL 15C2	980 45 097 0	SKALENFUEHRUNG 18C4,23C2	990 81 014 5	NADEL 971 B1 CF 110 13A7	992 02 436 0	ZYL.STIFT 29C2,29H10
980 42 060 0	SCHALTERH. 91H0,25B2, 26B2,27B2	980 43 006 0	AUSLOESEHEBEL 985	980 45 036 0	ZWISCHENPLATTE 20J10, 20K8,21J10,21K8,22J10,22K8	980 45 098 0	SKALENFUEHRUNG 18C4,23C2	990 81 014 6	NADEL 971 B1 CF 110 13A7	992 02 453 7	L.I.ZYL.SCHR. 992 00 492 7
980 42 063 0	HALTEBLECH 25H3,26H3,27H3	980 43 007 0	ISOLIERPLATTE 9A4,9C4	980 45 037 0	ZWISCHENPLATTE 20J10, 20K8,21J10,21K8,22J10,22K8	980 45 099 0	SKALENFUEHRUNG 18C4,23C2	990 81 014 7	NADEL 971 B1 CF 110 13A7	992 01 492 7	6KT.MUTTER 8A11,8A14
980 42 065 0	ROHRNIPPEL 25H7,26H7,27H7	980 43 008 0	SCHEIBE 5C2,5E7	980 45 040 0	UEBERGANGSLEISTE 18K9, 19M9,20M9,21M9,22M9,23L9	980 45 100 0	SKALENFUEHRUNG 18C4,23C2	990 81 014 8	NADEL 971 B1 CF 110 13A7	992 00 665 0	GEWINDESTIFT 2K1
980 42 068 0	STUETZE 25C3,26C3,27C3	980 43 009 0	SCHEIBE 5B8	980 45 101 0	MUTTER 4/1B7,12F10,13F10	980 45 101 0	MUTTER 4/1B7,12F10,13F10	990 81 014 9	NADEL 971 B1 CF 110 13A7	992 00 674 0	L.I.SENKSCHR. 266
980 42 069 0	STELLWINKEL 26E5	980 43 011 3	ZAHNRAD 21L10	980 45 102 0	MUTTER 4/1B7,12F10,13F10	980 45 102 0	MUTTER 4/1B7,12F10,13F10	990 81 015 0	STECKSCHLUESSEL 12E4, 12F11, 13E4,13F11	992 00 674 6	L.I.SENKSCHR. 1E6
		980 43 012 0	SCHEIBE 21L10								
		980 43 013 0	MUTTER 12F10,13F10								

Ersatzteilleiste. Spare parts. Pièces de rechange. Piezas de repuesto.

Teile-Nr.	Benennung	Teile-Nr.	Benennung	Teile-Nr.	Benennung	Teile-Nr.	Benennung	Teile-Nr.	Benennung	Teile-Nr.	Benennung	
993 03 145 0	SENKSSCHR. M4x35	17/1H6		26H1,27H1		25A4,26A4,27A4		16M11,17F15,18K9,19J9,19K8,19K9,19K11,19L8,19L9,20J9,20K8,20K9,20K11,20L8,20L9,21J8,21J9,21K9,21K11,21L8,21L9,22J9,22K9,22K11,22L8,22L9,23K11,23L9,23L10,24E9,24G8,25B12,25G6,26D6,26B12,27B12,27D6,29K11	993 52 116 0	GEW.STIFT M6x8 3F2,3F3,4/1A7,4/1A8	993 91 104 7	ZYL.SCHR. M5x16 5F8,15A1,15B4,18E3,23E6,25A6,26A6,27A6
993 03 145 7	SENKSSCHR. M4x35								993 54 611 7	SCHLAGMUTTER M4	993 91 104 8	ZYL.SCHR. M5x16 28M6
993 03 156 0	SENKSSCHR. M5x10	1486		9F1,9M3,11M11		17J15			993 67 157 0	RAENDELSCHR. M6x12	993 91 106 7	ZYL.SCHR. M5x20 1J6,17B5,28M7,28M6
993 03 156 7	SENKSSCHR. M5x10	14C11				25L7,26L7,27L7			993 67 157 7	RAENDELSCHR. M6x12	993 91 106 8	ZYL.SCHR. M5x20 14F11,28L7
993 03 177 7	SENKSSCHR. M6x14	17/1F4							993 72 021 0	NIETE	993 91 108 8	ZYL.SCHR. M5x25 14E10,14E11
993 03 178 0	SENKSSCHR. M6x16								993 90 400 8	SETZSCHR	993 91 110 7	ZYL.SCHR. M5x35 14L11
993 03 178 7	SENKSSCHR. M6x16	14C11,25E3,25G3,25G9,26E3,26G3,27E3,27G3,27G9		25J11,26J11,27J11		17J13			993 91 080 7	ZYL.SCHR. M4x6 1F3,2J5,17D16,18J6,22H6,25B4,26B4,27B4	993 91 121 7	ZYL.SCHR. M6x8 16B2,16B3,16B6,16B10,17D16,18D10,18E7,19D10,20D10,21D10,23E8,23E11
993 03 722 0	SENKSSCHR. M3x4	18K6		9L9		17J13			993 91 080 8	ZYL.SCHR. M4x6	993 91 121 8	ZYL.SCHR. M6x8
993 03 722 7	SENKSSCHR. M3x4	19J6,19L9,20J5,21J6,22J6,23H12,23L9		25J7,26H7,27H7		17F3			993 91 081 7	ZYL.SCHR. M4x8 1G5,1K7,3H5,4B8,16G2,16B6,16B7,16B10,16C8,16D7,16H2,16H6,16H10,17B3,17B14,17C2,17E1,17/1C2,17/1B3,28K3	993 91 121 9	ZYL.SCHR. M6x8
993 03 725 0	SENKSSCHR. M3x8								993 91 081 8	ZYL.SCHR. M4x8	993 91 122 7	ZYL.SCHR. M6x10 14E10,14E11
993 03 765 0	SENKSSCHR. M4x8								993 91 082 7	ZYL.SCHR. M4x10 1G5,1K6,1K7,4H4,4H8,4H12,5B7,5H2,17D17,17F1,17H5,17/1H5,19G11,20G12,21G12,22G11,24F6,24F5,25B2,26B2,27B2,29C4,29J12	993 91 122 8	ZYL.SCHR. M6x12 5M5,11E5,14H5,14K2,14M8,20K8,20K10,21J10,21K8,22F7,22F10,22J10,22K9,23G10,23J1,23K4,25J11,25G5,26J11,27J11,27F5,28H7,28K5,28G8,29D2,29C5,29D6,29F6
993 03 765 7	SENKSSCHR. M4x8	26I,19H10,20H10,21G9,22H10,23H8							993 91 082 8	ZYL.SCHR. M4x10	993 91 123 7	ZYL.SCHR. M6x12 5M5,11E5,14H5,14K2,14M8,20K8,20K10,21J10,21K8,22F7,22F10,22J10,22K9,23G10,23J1,23K4,25J11,25G5,26J11,27J11,27F5,28H7,28K5,28G8,29D2,29C5,29D6,29F6
993 03 766 0	SENKSSCHR. M4x10								993 91 083 7	ZYL.SCHR. M4x12 1L2,1G5,3D2,16F2,16F6,17F15,17K4,17/1K4,18C3,18E8,18F8,18J10,18J9,18K9,19E6,19F7,19J8,19J9,19J10,19J11,19K9,20L11,20E6,20E8,20G7,20L10,21E6,21F8,21J8,21J9,21J11,21K9,21L9,22E6,22E8,22F7,22J8,22J9,22J11,22K9,22L8,22L9,22L10,22L11,23C2,23G9,23J10,23J11,23K9,24D1,24D2,24H1,24H3,24H4,25B2,26B2,27B2,29F4,29L9	993 91 123 8	ZYL.SCHR. M6x12
993 03 766 7	SENKSSCHR. M4x10	4/1H10,17K13,25D10,26E10,26G9,27D10,28H5,28J5,28K5							993 91 083 8	ZYL.SCHR. M4x12 1L2,1G5,3D2,16F2,16F6,17F15,17K4,17/1K4,18C3,18E8,18F8,18J10,18J9,18K9,19E6,19F7,19J8,19J9,19J10,19J11,19K9,20L11,20E6,20E8,20G7,20L10,21E6,21F8,21J8,21J9,21J11,21K9,21L9,22E6,22E8,22F7,22J8,22J9,22J11,22K9,22L8,22L9,22L10,22L11,23C2,23G9,23J10,23J11,23K9,24D1,24D2,24H1,24H3,24H4,25B2,26B2,27B2,29F4,29L9	993 91 124 7	ZYL.SCHR. M6x16 8D4,8L9,9H10,9K11,14D8,14J4,14L7,16B11,16C1,16C9,16D5,16F4,16E7,16F11,16J1,16J5,16J9,16K5,16K9,17D4,17F2,17/1F3,17G2,18D7,18D8,18D9,18G9,18H7,18H3,18K3,19D8,19D9,19H7,20D8,20D9,20H7,21D7,21D9,21F9,21H9,22H9,23D10,23E8,23J2,23J4,23J6,23K2,23K5,25B6,25C6,26B6,26C6,27B7,27C6,28G7,28F9,29E2,29J9,17/1F2,17/1G2
993 04 000 0	ZYL.SCHR. M3x15x9								993 91 084 7	ZYL.SCHR. M4x16 182,9G10,17C5,25B3,26B3,27B3	993 91 124 8	ZYL.SCHR. M6x16 16B9
993 04 000 7	ZYL.SCHR. M3x15x9	28E11							993 91 084 8	ZYL.SCHR. M4x16 182,9G10,17C5,25B3,26B3,27B3	993 91 124 9	ZYL.SCHR. M6x16 16B9
993 06 094 0	ZYL.SCHR. M3x6								993 91 085 7	ZYL.SCHR. M4x18 1A8,4J2,4J6,4J10,18D7,18D8,18D9,19D7,19D9,20D6,20D8,20D9,21D7,21D8,21D8,23D8,23D9,25D3,26D3,27D3	993 91 125 7	ZYL.SCHR. M6x18 14D8
993 06 094 7	ZYL.SCHR. M3x6	4E10							993 91 102 7	ZYL.SCHR. M5x10 9J6,11L9,14B6,25D10,26D10,27D10	993 91 125 8	ZYL.SCHR. M6x18 14L8,23E7,23F9,29F5
993 06 095 7	ZYL.SCHR. M3x8	4D5,409							993 91 102 8	ZYL.SCHR. M5x10 9J6,11L9,14B6,25D10,26D10,27D10	993 91 125 9	ZYL.SCHR. M6x18 14L8,23E7,23F9,29F5
993 06 096 0	ZYL.SCHR. M3x10								993 91 103 7	ZYL.SCHR. M5x12 1E5,1F5,2E4,2G7,24E3	993 91 103 8	ZYL.SCHR. M6x12 26B7,26D12,27B7,27B12
993 06 096 7	ZYL.SCHR. M3x10	4D9,18K9,20M9,21M9,22M9							993 91 103 8	ZYL.SCHR. M5x12 1E5,1F5,2E4,2G7,24E3		
993 06 097 7	ZYL.SCHR. M3x8	19H7,20F11,20J6,21F11,21H7,22F11,22H7										
993 06 098 0	ZYL.SCHR. M3x16											
993 06 098 7	ZYL.SCHR. M3x16	1L7										
993 06 100 0	ZYL.SCHR. M3x20											
993 06 100 7	ZYL.SCHR. M3x20	14H8,14M4										
993 06 133 7	ZYL.SCHR. M4x5	16C7,16D4,16D11,18F10,19F12,19H6,20F12,20H5,21F12,21H6,22F11										
993 06 134 0	ZYL.SCHR. M4x6	11H11										
993 06 134 7	ZYL.SCHR. M4x6	5D7,5K1,9D3,11L3										
993 06 135 0	ZYL.SCHR. M4x8											
993 06 135 7	ZYL.SCHR. M4x8	26S,5J2,17/1C6										
993 06 136 0	ZYL.SCHR. M4x10	11L12										
993 06 136 7	ZYL.SCHR. M4x10											
993 06 137 0	ZYL.SCHR. M4x12											
993 06 137 7	ZYL.SCHR. M4x12	5D7,5K1,8G10,14L4										
993 06 140 0	ZYL.SCHR. M4x20											
993 06 140 7	ZYL.SCHR. M4x20	25H1,										
993 06 142 0	ZYL.SCHR. M4x25											
993 06 142 7	ZYL.SCHR. M4x25	9F1,9M3,11M11										
993 06 146 0	ZYL.SCHR. M4x40											
993 06 146 7	ZYL.SCHR. M4x40	14H11										
993 06 154 0	ZYL.SCHR. M5x6											
993 06 154 7	ZYL.SCHR. M5x6	25J11,26J11,27J11										
993 06 155 7	ZYL.SCHR. M5x8											
993 06 156 0	ZYL.SCHR. M5x10											
993 06 156 7	ZYL.SCHR. M5x10	25J7,26H7,27H7										
993 06 176 0	ZYL.SCHR. M6x10											
993 06 176 7	ZYL.SCHR. M6x10											
993 06 654 0	ZYL.SCHR. M2,6x6											
993 06 672 0	ZYL.SCHR. M3x4											
993 06 673 0	ZYL.SCHR. M3x5	2H6										
993 06 674 0	ZYL.SCHR. M3x6	2H5										
993 06 674 7	ZYL.SCHR. M3x6											
993 06 676 0	ZYL.SCHR. M3x10	1J3										
993 06 676 7	ZYL.SCHR. M3x10	9B6										
993 06 677 0	ZYL.SCHR. M3x12											
993 06 677 7	ZYL.SCHR. M3x12	9E5										
993 06 680 0	ZYL.SCHR. M3x20	9A6,9D5										
993 06 682 0	ZYL.SCHR. M3x25											
993 06 682 7	ZYL.SCHR. M3x25	28L5,29K5,29M5,29G8										
993 06 684 7	ZYL.SCHR. M3x30	17B3										
993 06 696 0	ZYL.SCHR. M3,5x10	104										
993 06 713 0	ZYL.SCHR. M4x5											
993 06 713 7	ZYL.SCHR. M4x5	25B4,25K5,25M5,26M6,26B4,26M5,26M6,26K5,27B4,27M5,27M6,27K5										
993 06 714 0	ZYL.SCHR. M4x6											
993 06 714 7	ZYL.SCHR. M4x6	28E9,28D10										
993 06 715 0	ZYL.SCHR. M4x8	18G7,19F9,19G7,20F9,20G7,21F9,21G7,22F9,22G7										
993 06 715 7	ZYL.SCHR. M4x8	28A4,28D4										
993 06 716 0	ZYL.SCHR. M4x10	28G11										
993 06 716 7	ZYL.SCHR. M4x10	28F12,28G12										
993 06 717 0	ZYL.SCHR. M4x12	1M5										
993 06 717 7	ZYL.SCHR. M4x12											
993 06 718 0	ZYL.SCHR. M4x16											
993 06 718 7	ZYL.SCHR. M4x16	28L4,28M4,28N4,28P4,28Q4,28R4,28S4,28T4,28U4,28V4,28W4,28X4,28Y4,28Z4										
993 06 720 0	ZYL.SCHR. M4x20											
993 06 720 7	ZYL.SCHR. M4x20	9K3										
993 06 721 6	ZYL.SCHR. M4x22	17/1C5										
993 06 724 0	ZYL.SCHR. M4x30											
993 06 724 7	ZYL.SCHR. M4x30	9F10,9G12										
993 06 736 0	ZYL.SCHR. M5x10											
993 06 736 7	ZYL.SCHR. M5x10	17J15										
993 06 737 0	ZYL.SCHR. M5x12											
993 06 737 7	ZYL.SCHR. M5x12	25L7,26L7,27L7										
993 06 739 0	ZYL.SCHR. M5x18	11H4										
993 06 739 7	ZYL.SCHR. M5x18	11K4										
993 06 744 0	ZYL.SCHR. M5x30											

Ersatzteilleiste. Spare parts. Pièces de rechange. Piezas de repuesto.

Teile-Nr.	Benennung	Teile-Nr.	Benennung	Teile-Nr.	Benennung	Teile-Nr.	Benennung	Teile-Nr.	Benennung	Teile-Nr.	Benennung
993 91 126 8	ZYL.SCHR. M6X20		25G11,26G11,26K3,27G11,27K3	993 91 126 8	ZYL.SCHR. M6X20		25G11,26G11,26K3,27G11,27K3	993 91 126 8	ZYL.SCHR. M6X20		25G11,26G11,26K3,27G11,27K3
993 91 127 7	ZYL.SCHR. M6x22 8D6,14F11			993 91 127 7	ZYL.SCHR. M6x22 8D6,14F11			993 91 127 7	ZYL.SCHR. M6x22 8D6,14F11		
993 91 123 7	ZYL.SCHR. M6X12 5M5,11E5,14H5,14K2,14M8,20K8,20K10,21J10,21K8,22F7,22F10,22J10,22K9,23G10,23J1,23K4,25J11,25G5,26J11,27J11,27F5,28H7,28K5,28G8,29D2,29C5,29D6,29F6	993 91 144 8	ZYL.SCHR. M8X16	993 91 144 8	ZYL.SCHR. M8X16			993 91 144 8	ZYL.SCHR. M8X16		
993 91 124 7	ZYL.SCHR. M6X16 8D4,8L9,9H10,9K11,14D8,14J4,14L7,16B11,16C1,16C9,16D5,16F4,16E7,16F11,16J1,16J5,16J9,16K5,16K9,17D4,17F2,17G2,18D7,18D8,18D9,18E9,18H7,18H3,18K3,19D8,19D9,19H7,20D8,20D9,20H7,21D7,21D9,21F9,21H9,22H9,23D10,23E8,23J2,23J4,23J6,23K2,23K5,25B6,25C6,26B6,26C6,27B7,27C6,28G7,28F9,29E2,29J9,17/1F2,17/1G2	993 91 146 7	ZYL.SCHR. M8X20 4L10,28K8,28C11,28A10	993 91 146 7	ZYL.SCHR. M8X20 4L10,28K8,28C11,28A10			993 91 146 7	ZYL.SCHR. M8X20 4L10,28K8,28C11,28A10		
993 91 125 8	ZYL.SCHR. M6X18 16B9,14D8,14L8,23E7,23F9,29F5	993 91 148 8	ZYL.SCHR. M8X25 564,25G11,25G12,26G11,26F11,27G12	993 91 148 8	ZYL.SCHR. M8X25 564,25G11,25G12,26G11,26F11,27G12			993 91 148 8	ZYL.SCHR. M8X25 564,25G11,25G12,26G11,26F11,27G12		
993 91 126 7	ZYL.SCHR. M6X20 184,1H5,2B4,3C4,8B4,14B8,14K6,17F17,17H17,18E9,18F6,18F7,18F8,18H4,18H3,19E6,19E8,19F6,19F8,19F9,20E8,20F6,20F8,21E6,21E8,21F7,22E6,22E9,24L4,25B7,25D12,26B7,26D12,27B7,27B12	993 91 150 8	ZYL.SCHR. M8X35 8L3,12K1,12K7,13K1,13K7	993 91 150 8	ZYL.SCHR. M8X35 8L3,12K1,12K7,13K1,13K7			993 91 150 8	ZYL.SCHR. M8X35 8L3,12K1,12K7,13K1,13K7		
993 91 127 7	ZYL.SCHR. M6x22 8D6,14F11,14J4,15A2	993 91 152 7	ZYL.SCHR. M8x45 18C3,18D1,18D4,21B3,23C5	993 91 152 7	ZYL.SCHR. M8x45 18C3,18D1,18D4,21B3,23C5			993 91 152 7	ZYL.SCHR. M8x45 18C3,18D1,18D4,21B3,23C5		
993 91 128 7	ZYL.SCHR. M6x25 8J12,9B2,14L11,15B6,16F10,16M3,16M7,16M11,18K2,28K6,28L7,29A2,29F12,29H11	993 91 153 7	ZYL.SCHR. M8x45 18C3,18D1,18D4,21B3,23C5	993 91 153 7	ZYL.SCHR. M8x45 18C3,18D1,18D4,21B3,23C5			993 91 153 7	ZYL.SCHR. M8x45 18C3,18D1,18D4,21B3,23C5		
993 91 129 8	ZYL.SCHR. M6x25 14G6	993 91 154 8	ZYL.SCHR. M8x50 18H3,23J4,25H12,26H12,27H12	993 91 154 8	ZYL.SCHR. M8x50 18H3,23J4,25H12,26H12,27H12			993 91 154 8	ZYL.SCHR. M8x50 18H3,23J4,25H12,26H12,27H12		
993 91 129 8	ZYL.SCHR. M6x30	993 91 155 8	ZYL.SCHR. M8x50 18H3,23J4,25H12,26H12,27H12	993 91 155 8	ZYL.SCHR. M8x50 18H3,23J4,25H12,26H12,27H12			993 91 155 8	ZYL.SCHR. M8x50 18H3,23J4,25H12,26H12,27H12		
993 91 130 7	ZYL.SCHR. M6x35 5E2,14K11,18D6,18D8,19D6,19D8,20D6,20D8,21D6,21D8,22D6,22D8,23D6,23D8	993 91 156 7	ZYL.SCHR. M8x35 8K10,11B11,18C3,18D4	993 91 156 7	ZYL.SCHR. M8x35 8K10,11B11,18C3,18D4			993 91 156 7	ZYL.SCHR. M8x35 8K10,11B11,18C3,18D4		
993 91 130 8	ZYL.SCHR. M6x35 5E7	993 91 157 8	ZYL.SCHR. M8x45 18C3,18D1,18D4,21B3,23C5	993 91 157 8	ZYL.SCHR. M8x45 18C3,18D1,18D4,21B3,23C5			993 91 157 8	ZYL.SCHR. M8x45 18C3,18D1,18D4,21B3,23C5		
993 91 135 7	ZYL.SCHR. M6x60 4L3	993 91 158 8	ZYL.SCHR. M8x45 18C3,18D1,18D4,21B3,23C5	993 91 158 8	ZYL.SCHR. M8x45 18C3,18D1,18D4,21B3,23C5			993 91 158 8	ZYL.SCHR. M8x45 18C3,18D1,18D4,21B3,23C5		
993 91 135 8	ZYL.SCHR. M6x60	993 91 159 8	ZYL.SCHR. M8x50 18H3,23J4,25H12,26H12,27H12	993 91 159 8	ZYL.SCHR. M8x50 18H3,23J4,25H12,26H12,27H12			993 91 159 8	ZYL.SCHR. M8x50 18H3,23J4,25H12,26H12,27H12		
993 91 144 7	ZYL.SCHR. M8x16 2F9,25H3,	993 91 160 8	ZYL.SCHR. M8x10 25G11,25L3,26G11,26L3,27G11,27L3	993 91 160 8	ZYL.SCHR. M8x10 25G11,25L3,26G11,26L3,27G11,27L3			993 91 160 8	ZYL.SCHR. M8x10 25G11,25L3,26G11,26L3,27G11,27L3		
		993 91 174 8	ZYL.SCHR. M10x16 1E2,2C11,2D2,2D4,3C9	993 91 174 8	ZYL.SCHR. M10x16 1E2,2C11,2D2,2D4,3C9			993 91 174 8	ZYL.SCHR. M10x16 1E2,2C11,2D2,2D4,3C9		
		993 91 178 7	ZYL.SCHR. M10x25	993 91 178 7	ZYL.SCHR. M10x25			993 91 178 7	ZYL.SCHR. M10x25		
		993 91 178 8	ZYL.SCHR. M10x25	993 91 178 8	ZYL.SCHR. M10x25			993 91 178 8	ZYL.SCHR. M10x25		
		993 91 179 7	ZYL.SCHR. M10x30 8M10	993 91 179 7	ZYL.SCHR. M10x30 8M10			993 91 179 7	ZYL.SCHR. M10x30 8M10		
		993 91 179 8	ZYL.SCHR. M10x30	993 91 179 8	ZYL.SCHR. M10x30			993 91 179 8	ZYL.SCHR. M10x30		
		993 91 180 7	ZYL.SCHR. M10x35 5M8,8F12,11C2,11E2,15B1,15D4	993 91 180 7	ZYL.SCHR. M10x35 5M8,8F12,11C2,11E2,15B1,15D4			993 91 180 7	ZYL.SCHR. M10x35 5M8,8F12,11C2,11E2,15B1,15D4		
		993 91 180 8	ZYL.SCHR. M10x35	993 91 180 8	ZYL.SCHR. M10x35			993 91 180 8	ZYL.SCHR. M10x35		
		993 91 182 7	ZYL.SCHR. M10x45	993 91 182 7	ZYL.SCHR. M10x45			993 91 182 7	ZYL.SCHR. M10x45		
		993 91 182 8	ZYL.SCHR. M10x45	993 91 182 8	ZYL.SCHR. M10x45			993 91 182 8	ZYL.SCHR. M10x45		
		993 91 187 7	ZYL.SCHR. M10x70 9B2	993 91 187 7	ZYL.SCHR. M10x70 9B2			993 91 187 7	ZYL.SCHR. M10x70 9B2		
		993 91 187 8	ZYL.SCHR. M10x70	993 91 187 8	ZYL.SCHR. M10x70			993 91 187 8	ZYL.SCHR. M10x70		
		993 91 189 7	ZYL.SCHR. M10x80	993 91 189 7	ZYL.SCHR. M10x80			993 91 189 7	ZYL.SCHR. M10x80		
		993 91 189 8	ZYL.SCHR. M10x80	993 91 189 8	ZYL.SCHR. M10x80			993 91 189 8	ZYL.SCHR. M10x80		
		993 91 208 7	ZYL.SCHR. M12x25 8E3,8E5	993 91 208 7	ZYL.SCHR. M12x25 8E3,8E5			993 91 208 7	ZYL.SCHR. M12x25 8E3,8E5		
		993 91 208 8	ZYL.SCHR. M12x25	993 91 208 8	ZYL.SCHR. M12x25			993 91 208 8	ZYL.SCHR. M12x25		
		993 91 209 7	ZYL.SCHR. M12x30 869	993 91 209 7	ZYL.SCHR. M12x30 869			993 91 209 7	ZYL.SCHR. M12x30 869		
		993 91 209 8	ZYL.SCHR. M12x30	993 91 209 8	ZYL.SCHR. M12x30			993 91 209 8	ZYL.SCHR. M12x30		
		993 91 211 7	ZYL.SCHR. M12x40 28F5,28G5	993 91 211 7	ZYL.SCHR. M12x40 28F5,28G5			993 91 211 7	ZYL.SCHR. M12x40 28F5,28G5		
		993 91 211 8	ZYL.SCHR. M12x40	993 91 211 8	ZYL.SCHR. M12x40			993 91 211 8	ZYL.SCHR. M12x40		
		993 91 212 7	ZYL.SCHR. M12x45 8F9,8D10	993 91 212 7	ZYL.SCHR. M12x45 8F9,8D10			993 91 212 7	ZYL.SCHR. M12x45 8F9,8D10		
		993 91 212 8	ZYL.SCHR. M12x45	993 91 212 8	ZYL.SCHR. M12x45			993 91 212 8	ZYL.SCHR. M12x45		
		993 92 069 8	6KT INNEN 1E4	993 92 069 8	6KT INNEN 1E4			993 92 069 8	6KT INNEN 1E4		
		993 92 099 8	GEW.STIFT M5x6 1K6,1L7	993 92 099 8	GEW.STIFT M5x6 1K6,1L7			993 92 099 8	GEW.STIFT M5x6 1K6,1L7		
		993 92 111 7	GEW.STIFT M6x10 18E1,18E3,18F1,18F3,23H6,23J1,23L2,25C3,26C3,27C3	993 92 111 7	GEW.STIFT M6x10 18E1,18E3,18F1,18F3,23H6,23J1,23L2,25C3,26C3,27C3			993 92 111 7	GEW.STIFT M6x10 18E1,18E3,18F1,18F3,23H6,23J1,23L2,25C3,26C3,27C3		
		993 92 111 8	GEW.STIFT M6x10 13C7	993 92 111 8	GEW.STIFT M6x10 13C7			993 92 111 8	GEW.STIFT M6x10 13C7		
		993 92 111 9	GEW.STIFT M6x10 13C7	993 92 111 9	GEW.STIFT M6x10 13C7			993 92 111 9	GEW.STIFT M6x10 13C7		
		993 92 114 7	GEW.STIFT M6X20 25E4,	993 92 114 7	GEW.STIFT M6X20 25E4,			993 92 114 7	GEW.STIFT M6X20 25E4,		
		993 92 116 7	GEW.STIFT M6X30 25D3,26D3,27D3	993 92 116 7	GEW.STIFT M6X30 25D3,26D3,27D3			993 92 116 7	GEW.STIFT M6X30 25D3,26D3,27D3		
		993 92 120 8	GEW.STIFT M8X8 28F8	993 92 120 8	GEW.STIFT M8X8 28F8			993 92 120 8	GEW.STIFT M8X8 28F8		
		993 92 122 7	GEW.STIFT M8X12 5D4,5C9,5J6,25H1,25H5,26H1,26H5,27H1,27H5,29E8,29E9	993 92 122 7	GEW.STIFT M8X12 5D4,5C9,5J6,25H1,25H5,26H1,26H5,27H1,27H5,29E8,29E9			993 92 122 7	GEW.STIFT M8X12 5D4,5C9,5J6,25H1,25H5,26H1,26H5,27H1,27H5,29E8,29E9		
		993 92 183 7	GEW.STIFT M16X70 8L3,12K1,12K7,13K1,13K7	993 92 183 7	GEW.STIFT M16X70 8L3,12K1,12K7,13K1,13K7			993 92 183 7	GEW.STIFT M16X70 8L3,12K1,12K7,13K1,13K7		
		993 93 100 7	GEW.STIFT M5x8 8B10	993 93 100 7	GEW.STIFT M5x8 8B10			993 93 100 7	GEW.STIFT M5x8 8B10		
		993 93 083 7	GEW.STIFT M4x8 1L4	993 93 083 7	GEW.STIFT M4x8 1L4			993 93 083 7	GEW.STIFT M4x8 1L4		
		993 93 103 7	GEW.STIFT M6x8 5H7	993 93 103 7	GEW.STIFT M6x8 5H7			993 93 103 7	GEW.STIFT M6x8 5H7		
		993 93 104 7	GEW.STIFT M6X10 5E5,5E10,14F6,14G9,14L2	993 93 104 7	GEW.STIFT M6X10 5E5,5E10,14F6,14G9,14L2			993 93 104 7	GEW.STIFT M6X10 5E5,5E10,14F6,14G9,14L2		
		993 96 042 0	FL.KOPFSCHR. M2X2 1E2,2E2	993 96 042 0	FL.KOPFSCHR. M2X2 1E2,2E2			993 96 042 0	FL.KOPFSCHR. M2X2 1E2,2E2		
		993 96 077 0	FL.KOPFSCHR. M2,6X5	993 96 077 0	FL.KOPFSCHR. M2,6X5			993 96 077 0	FL.KOPFSCHR. M2,6X5		
		993 96 094 0	FL.KOPFSCHR. M3X3	993 96 094 0	FL.KOPFSCHR. M3X3			993 96 094 0	FL.KOPFSCHR. M3X3		
		993 96 158 0	FL.KOPFSCHR. M5X6 2E5	993 96 158 0	FL.KOPFSCHR. M5X6 2E5			993 96 158 0	FL.KOPFSCHR. M5X6 2E5		
		993 96 160 0	FL.KOPFSCHR. M5X10 1C11,1E2,2C11,2D2,2D4,3C9	993 96 160 0	FL.KOPFSCHR. M5X10 1C11,1E2,2C11,2D2,2D4,3C9			993 96 160 0	FL.KOPFSCHR. M5X10 1C11,1E2,2C11,2D2,2D4,3C9		
		993 96 160 7	FL.KOPFSCHR. M5x10 1C11,1E2,2C11,2D2,2D4,3C9	993 96 160 7	FL.KOPFSCHR. M5x10 1C11,1E2,2C11,2D2,2D4,3C9			993 96 160 7	FL.KOPFSCHR. M5x10 1C11,1E2,2C11,2D2,2D4,3C9		
		993 97 098 0	FL.KOPFSCHR. M4x8 4B9,4D10	993 97 098 0	FL.KOPFSCHR. M4x8 4B9,4D10			993 97 098 0	FL.KOPFSCHR. M4x8 4B9,4D10		
		993 99 191 0	FL.KOPFSCHR. M6x8 25G4,26G4,29G8	993 99 191 0	FL.KOPFSCHR. M6x8 25G4,26G4,29G8			993 99 191 0	FL.KOPFSCHR. M6x8 25G4,26G4,29G8		
		994 03 201 0	6KT.SCHR. M8x35 25H9,26H9,27H9	994 03 201 0	6KT.SCHR. M8x35 25H9,26H9,27H9			994 03 201 0	6KT.SCHR. M8x35 25H9,26H9,27H9		
		994 04 109 8	6KT.SCHR. M3x12 1B1,2B1	994 04 109 8	6KT.SCHR. M3x12 1B1,2B1			994 04 109 8	6KT.SCHR. M3x12 1B1,2B1		
		994 04 109 7	6KT.SCHR. M3X12 4D10	994 04 109 7	6KT.SCHR. M3X12 4D10			994 04 109 7	6KT.SCHR. M3X12 4D10		
		994 04 144 6	6KT.SCHR. M4 x6 1E2,2E2,2F2,12B1,12B7,13B7,13C1	994 04 144 6	6KT.SCHR. M4 x6 1E2,2E2,2F2,12B1,12B7,13B7,13C1			994 04 144 6	6KT.SCHR. M4 x6 1E2,2E2,2F2,12B1,12B7,13B7,13C1		
		994 04 147 7	6KT.SCHR. M4 x6 17F1,17/1F1	994 04 147 7	6KT.SCHR. M4 x6 17F1,17/1F1						

Ersatzteilleiste. Spare parts. Pièces de rechange. Piezas de repuesto.

Teile-Nr.	Benennung	Teile-Nr.	Benennung	Teile-Nr.	Benennung	Teile-Nr.	Benennung	Teile-Nr.	Benennung	Teile-Nr.	Benennung
996 01 303 8	SICH.RING 18X1,5	11L4		998 88 106 0	PASZSCHEIBE 20x28x0,3	999 20 065 3	ANFAHRROLLE AR 9F2,9L4,	1506,18E3,	999 22 045 4	VENTIL 11K9,25K8,26K8,	
995 10 061 0	VERSCHLUSZSCHR.R14	11C7,	16E10,16K2,16K6,16K10,		5C2,5D2,5D7		11L11	23E4		27K8,28J2,28L2,	
		11F7	1702,17016,17/102	998 88 111 0	PASZSCHEIBE 12x18x0,3	999 20 066 3	2-POL-UMSCHALTER 2A 10B8,	25M8,26M8,	999 21 013 3	SPREITZNIET 27M8	28E4,28G5
995 19 013 8	SPANNHUELSE 2X8	4E2,4E6,		998 88 161 0	PASZSCHEIBE 12x18x0,5	999 20 066 5	KLINGELTRAFO 110V 10F4,	27M8	999 21 015 1	GEW.EINSATZ 1601,1606,	
		4E10			8H11,		10E7,10F4,10F12			1609,16E10,16K1,16K5,16K9,	
995 34 013 5	GKT.MUTTER PG16A	984		998 88 210 0	PASZSCHEIBE 10x16x1	999 20 075 8	HILFSCHUTZ 10H6	16L6,16L10,17D16,18E9,	999 22 047 5	SCHLAUCHKLEMMLE 1A6	
995 34 061 7	GKT.MUTTER PG11x9			998 88 216 0	PASZSCHEIBE 20x28x1	999 20 079 7	MIKROSCH. 985,905	12B10,13B4,13B10,14H11,	999 22 047 6	EINSTECKHUELSE 4/1C11,	
995 34 061 8	GKT.MUTTER PG11x9	11M4			14H2,	999 20 079 8	HEBEL 985,905	25B1,25L2,26B1,26L2,27L2,			
996 01 081 8	SICHERUNGSRING 5x0,6				14K2	999 20 082 7	Z.RELAIS	27B1,28H8,28H1,28J1,28L1,			
996 01 082 8	SICHERUNGSRING 6x0,7	5D9,		998 91 014 0	SPRENGRING SB11	999 20 082 8	SCHUBRADSCHALTER 9D7	2804,28B5,28C5,28E4,28G10,			
		5E3,5F9,18D10,18E8,19D10,			1D10,2E4	999 20 083 2	SOCKELGEH.HAN 16A 9E2	28G8,28M9,29C7,29D8,29D5			
		19E7,20D10,20E8,21D10,21E7,		998 91 205 0	SPRENGRING SW9	999 20 085 3	BEF.SCHELLE 7 25C2,25M5,	11E1	999 21 023 5	PICCOLOSCHIEBE 8K11	
		22D9,22E7,23E11			1L6	999 20 085 4	BEF.SCHELLE 9 25C4,25K6,		999 21 024 7	STERNGRIF 8C4,8J12,24M4	
996 01 084 8	SICHERUNGSR.8x0,8	1K2,		998 99 023 8	SICH.SCHEIBE 8 14E5	999 20 085 5	BEF.SCHELLE 9 25C4,25K6,		999 21 024 9	MAGNETSCHNEPPER 1L7	
		11M12,18E3,18F1,18F3,18F4,		999 05 038 7	GKT.MUTTER M8x1	999 20 085 6	BEF.SCHELLE 13 11K3		999 21 025 6	KUPPLUNGSBELAG 8H9,8H10	
		18G1,23F3,23G1,23H6,23K4,		999 05 042 0	GKT.MUTTER M12X1	999 20 085 7	BEF.SCHELLE 19 11H11,		999 21 075 7	GUMMIFUSS 8L2	
		25C3,26C3,27C3		999 05 042 7	GKT.MUTTER M12X1	999 20 085 9	BEF.SCHELLE 19 11H11,		999 21 081 9	NUTMUTTER	
996 01 085 8	SICHERUNGSR. 9x1	8J9			8G9,	999 20 086 0	BEF.SCHELLE 29 4/189,4D10		999 21 083 5	NUTMUTTER 5F11,5H8,5K11,	
996 01 086 8	SICHERUNGSR.10x1	5D4,5D9,		999 19 022 6	DELTOPF NR36	999 20 086 1	KROFLEX.7x1 25K5,26K5,			5M7,11F5,11A2,	
		5F4		999 20 008 3	MIKROSCHALTER 28L5,29K5,	999 20 086 2	KROFLEX.10x1 25L8,25M8,			11B5,11F2	
996 01 088 8	SICHERUNGSR.12x1	5F1,5F7,			162	999 20 086 3	KROFLEX.10x1 25L8,25M8,		999 21 083 6	SICH.BLECH 5F11,5H8,	
		25G4,26G4,27G4		999 20 013 0	PILZTASTER 9J2	999 20 086 4	KROFLEX.10x1 25L8,25M8,			5K11,5M7,11F5,11F2,	
996 01 091 8	SICHERUNGSR.15x1	187,286,		999 20 020 1	ENDTASTER 9G1,9G12,25H1,	999 20 086 5	KROFLEX.10x1 25L8,25M8,			11B2,11B6	
		1801,23C2			1C7	999 20 086 6	KROFLEX.10x1 25L8,25M8,		999 22 001 4	3/2WEGEVENTIL 11L9,28E2,	
996 01 114 8	SICHERUNGSR.	8J9		999 20 022 8	DREHSTROMSCHUETZ 10G9	999 20 086 7	KROFLEX.10x1 25L8,25M8,			28F3	
996 01 303 8	SICH.RING 18X1,5	11L4		999 20 024 5	DREHSTROMSCHUETZ 10H9	999 20 087 0	PERLILEXSTECKER 9F5,9L8,		999 22 001 5	3/2WEGEVENTIL 25D2,25J2,	
996 02 113 8	SICH.RING 24X1,2	1M9,		999 20 024 6	DREHSTR.SCH. D1L00-44/59	999 20 087 1	TUELLENGH.HAN16A 9E3,9B6			26D2,26J2,	
		1M10			5G11,	999 20 087 2	KABELKASTEN 9F4		999 22 002 5	OELER 11C8	
996 02 116 8	SICH.RING 28X1,2	5H6		999 20 034 9	REIHENKLEMMLE 9F4	999 20 087 3	TUELLENGH.HAN16A 9E3,9B6		999 22 003 4	DRUCKL.ZYLINDER 11J12	
996 02 117 8	SICH.RING 30X1,2	15B10		999 20 035 2	TRAGSCHIENE 9G3	999 20 087 4	KABELKASTEN 9F4		999 22 012 4	MIKROZYLINDER 2905,29K9	
996 02 127 8	SICH.RING 47X1,75	187,		999 20 037 9	BUCHSENKLEMMSCH. 9G9,	999 20 087 5	NYL.KABELBAND 1A5		999 22 012 6	MIKROZYLINDER 25G3,26G3,	
		1810,286,2810,388,306		999 20 038 0	BEZ.STREIFEN 9G9,25M8,	999 20 087 6	KLEMMKASTEN 9F9,25L7,			25G3,26G3,	
996 02 144 8	SICH.RING	8K10			26M8,27M8,28F10	999 20 087 7	PERLILEXSTECKER 9F5,9L8,		999 22 014 3	DRUCKL.ZYLINDER 11J10	
996 06 010 0	KUGEL 1,588	4G3,4G7,		999 20 042 4	ISOLIERST.GEH. 10H5	999 20 087 8	PERLILEXSTECKER 9F5,9L8,		999 22 015 2	DRUCKL.ZYLINDER 2909	
		4G11,4H3,4H7,4H11		999 20 043 1	ABDECKKAPPE 28L5,29J5,	999 20 087 9	PERLILEXSTECKER 9F5,9L8,		999 22 015 6	DRUCKL.ZYLINDER 25F3,	
					29F9	999 20 088 0	NYL.KABELBAND 1A5			26F3,27F3,28H10	
996 06 017 0	KUGEL 3,969	1C5,2C5		999 20 039 4	REIHENKLEMMLE 9F4	999 20 088 1	NYL.KABELBAND 1A5		999 22 015 5	DRUCKL.ZYLINDER 25G7,26G7,	
996 06 020 0	KUGEL 4,762	20F10		999 20 035 2	TRAGSCHIENE 9G3	999 20 088 2	NYL.KABELBAND 1A5		999 22 015 6	DRUCKL.ZYLINDER 25G7,26G7,	
996 07 003 8	SICH.SCHEIBE	17C14		999 20 037 9	BUCHSENKLEMMSCH. 9G9,	999 20 088 3	NYL.KABELBAND 1A5		999 22 015 6	DRUCKL.ZYLINDER 25G7,26G7,	
996 07 004 8	SICH.SCHEIBE 1,9				969,	999 20 088 4	NYL.KABELBAND 1A5		999 22 015 6	DRUCKL.ZYLINDER 25G7,26G7,	
996 07 006 8	SICH.SCHEIBE 3,2	18B,		999 20 038 0	BEZ.STREIFEN 9G9,25M8,	999 20 088 5	NYL.KABELBAND 1A5		999 22 015 6	DRUCKL.ZYLINDER 25G7,26G7,	
		1D1,2D2,4J3,4J7,4J11,24E6			26M8,27M8,28F10	999 20 088 6	NYL.KABELBAND 1A5		999 22 015 6	DRUCKL.ZYLINDER 25G7,26G7,	
996 07 007 7	SICH.SCHEIBE 4			999 20 042 4	ISOLIERST.GEH. 10H5	999 20 088 7	NYL.KABELBAND 1A5		999 22 015 6	DRUCKL.ZYLINDER 25G7,26G7,	
996 07 007 8	SICH.SCHEIBE 4	17K16,		999 20 043 1	ABDECKKAPPE 28L5,29J5,	999 20 088 8	NYL.KABELBAND 1A5		999 22 015 6	DRUCKL.ZYLINDER 25G7,26G7,	
		17M15,24F6,25D3,26D3,27D3			29F9	999 20 088 9	NYL.KABELBAND 1A5		999 22 015 6	DRUCKL.ZYLINDER 25G7,26G7,	
996 07 008 7	SICH.SCHEIBE 5	28J8,28K9,		999 20 044 0	WUERGENIPPEL PG16 9F4	999 20 088 0	NYL.KABELBAND 1A5		999 22 015 6	DRUCKL.ZYLINDER 25G7,26G7,	
		29L5,29E7,29M6		999 20 048 2	STECKEREINS.HAN 16A 9C1,	999 20 088 1	NYL.KABELBAND 1A5		999 22 015 6	DRUCKL.ZYLINDER 25G7,26G7,	
996 07 008 8	SICH.SCHEIBE 5	28J3,14G11,			9L2,9F3,9H4,9B6,9F11,9J7,	999 20 088 2	NYL.KABELBAND 1A5		999 22 015 6	DRUCKL.ZYLINDER 25G7,26G7,	
		14K11,23E8,23E9,23F7,		999 20 048 5	STECKDOSEINS. HAN16	999 20 088 3	NYL.KABELBAND 1A5		999 22 015 6	DRUCKL.ZYLINDER 25G7,26G7,	
		23F8,23F9,23E4			9D2,10L1,10L6	999 20 088 4	NYL.KABELBAND 1A5		999 22 015 6	DRUCKL.ZYLINDER 25G7,26G7,	
996 07 009 8	SICH.SCHEIBE 6	14L7		999 20 049 1	TUELLENGHAEUSE HAN16	999 20 088 5	NYL.KABELBAND 1A5		999 22 015 6	DRUCKL.ZYLINDER 25G7,26G7,	
996 07 010 8	SICH.SCHEIBE 7	1F10,289,			10B5,10E7,10F1,10F9	999 20 088 6	NYL.KABELBAND 1A5		999 22 015 6	DRUCKL.ZYLINDER 25G7,26G7,	
		8L11,8L10,8M11,8L12,11H11,17H16,		999 20 054 0	TRENNTRAFO 10A1,10B5,	999 20 088 7	NYL.KABELBAND 1A5		999 22 015 6	DRUCKL.ZYLINDER 25G7,26G7,	
		17H18,29E3,29K9			10F9	999 20 088 8	NYL.KABELBAND 1A5		999 22 015 6	DRUCKL.ZYLINDER 25G7,26G7,	
996 07 011 8	SICH.SCHEIBE 8	14E8		999 20 054 8	PILZTASTER 9J3	999 20 088 9	NYL.KABELBAND 1A5		999 22 015 6	DRUCKL.ZYLINDER 25G7,26G7,	
996 07 012 8	SICH.SCHEIBE 9	16D8,16E3,		999 20 054 9	KLINGELTRAFO 220V 10F12	999 20 089 0	NYL.KABELBAND 1A5		999 22 015 6	DRUCKL.ZYLINDER 25G7,26G7,	
					9G10,	999 20 089 1	NYL.KABELBAND 1A5		999 22 015 6	DRUCKL.ZYLINDER 25G7,26G7,	
					25A4,26A4,27A4	999 20 089 2	NYL.KABELBAND 1A5		999 22 015 6	DRUCKL.ZYLINDER 25G7,26G7,	
				999 20 061 5	ENDTASTER AT11A-2-I 9K3,	999 20 089 3	NYL.KABELBAND 1A5		999 22 015 6	DRUCKL.ZYLINDER 25G7,26G7,	
					9M3,11L11	999 20 089 4	NYL.KABELBAND 1A5		999 22 015 6	DRUCKL.ZYLINDER 25G7,26G7,	
				999 20 063 5	DREHSTROMSCHUETZ 10G1,	999 20 089 5	NYL.KABELBAND 1A5		999 22 015 6	DRUCKL.ZYLINDER 25G7,26G7,	
					10G6	999 20 089 6	NYL.KABELBAND 1A5		999 22 015 6	DRUCKL.ZYLINDER 25G7,26G7,	
				999 20 063 6	STEUERTRAFO 200 VA 10F2	999 20 089 7	NYL.KABELBAND 1A5		999 22 015 6	DRUCKL.ZYLINDER 25G7,26G7,	
						999 20 089 8	NYL.KABELBAND 1A5		999 22 015 6	DRUCKL.ZYLINDER 25G7,26G7,	
						999 20 089 9	NYL.KABELBAND 1A5		999 22 015 6	DRUCKL.ZYLINDER 25G7,26G7,	
						999 20 090 0	NYL.KABELBAND 1A5		999 22 015 6	DRUCKL.ZYLINDER 25G7,26G7,	
						999 20 090 1	NYL.KABELBAND 1A5		999 22 015 6	DRUCKL.ZYLINDER 25G7,26G7,	
						999 20 090 2	NYL.KABELBAND 1A5		999 22 015 6	DRUCKL.ZYLINDER 25G7,26G7,	
						999 20 090 3	NYL.KABELBAND 1A5		999 22 015 6	DRUCKL.ZYLINDER 25G7,26G7,	
						999 20 090 4	NYL.KABELBAND 1A5		999 22 015 6	DRUCKL.ZYLINDER 25G7,26G7,	
						999 20 090 5	NYL.KABELBAND 1A5		999 22 015 6	DRUCKL.ZYLINDER 25G7,26G7,	
						999 20 090 6	NYL.KABELBAND 1A5		999 22 015 6	DRUCKL.ZYLINDER 25G7,26G7,	
						999 20 090 7	NYL.KABELBAND 1A5		999 22 015 6	DRUCKL.ZYLINDER 25G7,26G7,	
						999 20 090 8	NYL.KABELBAND 1A5		999 22 015 6	DRUCKL.ZYLINDER 25G7,26G7,	
						999 20 090 9	NYL.KABELBAND 1A5		999 22 015 6	DRUCKL.ZYLINDER 25G7,26G7,	
						999 20 091 0	NYL.KABELBAND 1A5		999 22 015 6	DRUCKL.ZYLINDER 25G7,26G7,	
						999 20 091 1	NYL.KABELBAND 1A5		999 22 015 6	DRUCKL.ZYLINDER 25G7,26G7,	
						999 20 091 2	NYL.KABELBAND 1A5		999 22 015 6	DRUCKL.ZYLINDER 25G7,26G7,	
						999 20 091 3	NYL.KABELBAND 1A5		999 22 015 6	DRUCKL.ZYLINDER 25G7,26G7,	
						999 20 091 4	NYL				

Ersatzteilleiste. Spare parts. Pièces de rechange. Piezas de repuesto.

Teile-Nr.	Benennung	Teile-Nr.	Benennung	Teile-Nr.	Benennung
999 24 025 2	GDE-VERSCHRAUBUNG 11E9, 11J11,11K12,11L9,14K11, 25J1,26J1,27J1,28J1,28L1, 28C4,28D4,28E4,28B5,28D5, 28F5,28G5,28H7,28G10,28L9, 28L11,29D4,29D9				
999 24 025 5	WEV-VERSCHR. 618 4L4, 11B9,11H9,11K11,14D11, 14F11,14G4,14H8,17H14, 25K1,26K1,27K1,28G1,28H3, 28H5,28C3,28J10,28K11, 29A4,29B4,29D4,29B6,29C7, 29C9,29C11,29F9,29G9,29K9				
999 24 025 6	TEV-VERSCHR. 11K9,11L10, 14K11,25L1,26L1,27L1, 28H3,28G2				
999 24 025 8	TES-VERSCHR. 14D11, 14H11,25L1,26L1,27L1, 28H3,28K3,28C5,28H8, 28K10,28M10				
999 24 026 0	TR-VERSCHR. 4/1C11,25J6, 26J6,27J6,28L12,29A8, 29B8,29C8				
999 24 026 2	KR-VERSCHR. 4/1F12,25M1, 26M1,27M1				
999 24 026 9	BLINDSTOPFEN 1J1				
999 24 027 1	DICHRING 12A3,12A9, 13A4,13A9,25K2,25B1, 26K2,26B1,27K2,27B1				
999 24 027 3	SCHW-VERSCHR. 14F11,14H11				
999 24 027 8	T-SCHW-VERSCHR. 25J6, 26J6,27J6				
999 24 030 1	DOPPELNIPPEL R1/4 11C7, 11C8,11C9,11C10, 11D10,11E11,11G9				
999 24 030 2	DOPPELNIPPEL R1/8 14G4, 14H11,25G10,25E1,26E1, 27G10,27E1,28C4,28H8,28J11				
999 24 030 4	REDUZIERNIPPEL R1/4-1/8 11B9,11D10,11H9, 11K12,25J8,26J8, 27J8				
999 24 030 5	T-VERTEILERBLOCK R1/8 14H11,25J3,25E1,26J3, 26E1,27J3,27E1				
999 24 030 6	MUFFE R1/4 25G6,26G6, 27G6				
999 24 033 0	Y VERB.STUECK 1A6,				
999 24 033 4	T-BLOCK 25J8,26H8,27J8				
999 24 034 2	NORMASCHELLE 8M9,11A9, 14L8				
999 24 036 5	SCHWVERSCHRAUBUNG 14L11				
999 24 036 6	T-SCHWVERSCHRAUBUNG 14L11				
999 31 073 0	KERBSTIFT 17B5				
999 31 097 0	KERBSTIFT 14B6				
Jiskette: 504 Datei: KL.971/972 /Norm					