

---

**PFAFF<sup>®</sup> 489**

## **Unterklassen-Ausstattung**

Subclass parts

Composition des sous-classes

Composición de las subclases

## Equipement des sous-classes

## Dotación de las subclases

Unterklasse Subclass Sous-classe Subclase	Ausführung Model Version Tipo de máquina	Nadelslange Needle bar Barre à aiguille Barra de aguja	Stoffschieberpaar <sup>[4]</sup> Feed dog pair Paire de griffes Par de transportadores inferiores	Stoffschieber, vorn <sup>[5]</sup> Feed dog, front Griffe avant Elemento anterior del transportador inferior	Stoffschieber, hinten <sup>[5]</sup> Feed dog, rear Griffe arrière Elemento posterior del transportador inferior
-6/01*	BN 46	91-171 018-91	91-047 396-03	91-047 551-04	91-047 355-04
	CN 46		91-047 784-00 <sup>[28/2]</sup>	91-047 785-05 <sup>[28/2]</sup>	91-047 786-05 <sup>[28/2]</sup>
-32/21*	BN 46	91-171 018-91	91-047 394-03	91-047 356-04	91-047 357-04
			91-047 781-00 <sup>[28/2]</sup>	91-047 783-05 <sup>[28/2]</sup>	91-047 782-05 <sup>[28/2]</sup>
-34/01*	AN 46	91-171 018-91	91-047 394-03	91-047 356-04	91-047 357-04
	BN 46		91-047 781-00 <sup>[28/2]</sup>	91-047 783-05 <sup>[28/2]</sup>	91-047 782-05 <sup>[28/2]</sup>
-72/03*	AN 46	91-171 018-91	91-047 394-03	91-047 356-04	91-047 357-04
			91-047 781-00 <sup>[28/2]</sup>	91-047 783-05 <sup>[28/2]</sup>	91-047 782-05 <sup>[28/2]</sup>
-230/81*	BN 46	91-171 018-91	91-047 396-03	91-047 551-04	91-047 355-04
			91-047 784-00 <sup>[28/2]</sup>	91-047 785-05 <sup>[28/2]</sup>	91-047 786-05 <sup>[28/2]</sup>
-265/01*	A	91-171 018-91	91-047 394-03	91-047 356-04	91-047 357-04
			91-047 781-00 <sup>[28/2]</sup>	91-047 783-05 <sup>[28/2]</sup>	91-047 782-05 <sup>[28/2]</sup>
-265/02*	A	91-171 018-91	91-047 394-03	91-047 356-04	91-047 357-04
			91-047 781-00 <sup>[28/2]</sup>	91-047 783-05 <sup>[28/2]</sup>	91-047 782-05 <sup>[28/2]</sup>
-748/56-6/01*	BN 46	91-171 018-91	91-047 396-03	91-047 551-04	91-047 355-04
			91-047 784-00 <sup>[28/2]</sup>	91-047 785-05 <sup>[28/2]</sup>	91-047 786-05 <sup>[28/2]</sup>
-748/56-34/01*	AN 46	91-171 018-91	91-047 394-03	91-047 551-04	91-047 355-04
			91-047 784-00 <sup>[28/2]</sup>	91-047 784-05 <sup>[28/2]</sup>	91-047 786-05 <sup>[28/2]</sup>

\*) Unterklasse kann mit Faden-durchzieh- und -abschneideinrichtung -900/51; /99 geliefert werden; dabei bleiben die aufgeführten Bestellnummern unverändert.

\*) Subclass can be supplied with thread puller/trimmer -900/51; /99 in this case the ordering numbers listed remain unchanged.

\*) Sous-classe livrable avec coupe-fil -900/51; /99 les numéros de commande restent inchangés.

\*) La subclase se puede suministrar con el cortahilos automático -900/51; /99 permaneciendo invariables los números de pedido indicados.

<sup>[4]</sup> = Ausführung angeben  
= Indicate model  
= Preciser la version  
= Indíquese el tipo de máquina

<sup>[22]</sup> = Zubehör  
= Accessoires  
= Accesorios  
= Accesorios

<sup>[5]</sup> = Nähmuster einsenden  
= Submit sewing sample  
= Joindre échantillons de couture  
= Envíese muestra de costura

<sup>[28/2]</sup> = Mit Kunststoffbelag  
= With plastic coating  
= Avec revêtement plastique  
= Con recubrimiento de plástico

Equipement des sous-classes

Dotacion de las subclases

Unterklassen-Ausstattung

Subclass organization

Unterklasse Subclass Sous-classe Subclase	Ausführung Model Version Tipo de maquina	Stichplatte Needle plate Plaque à aiguille Placa de aguja	Nähfuß Presser foot Pied presseur Pie prensateelas	Apparat Attachment Appareil Aparato	Bandrollenträger Tape reel bracket Plateau derouleur Portarrollos	Bandführung Tape guide Guide-ruban Guiacintas
-6/01*	BN 46 CN 46	91-058 132-04	91-054 004-03 91-054 012-03 [22]			
-32/21*	BN 46	91-058 130-04	91-051 997-01	91-053 769-24		
-34/01*	AN 46 BN 46	91-058 130-04	91-054 084-03 91-054 051-03 [22]			
-72/03*	AN 46	91-058 130-04	91-051 997-01	91-050 838-91	91-056 553-92	91-053 953-21
-230/81*	BN 46	91-058 132-04	99-117 802-91 99-117 803-91			
-265/01*	A	91-058 130-04	91-051 922-23 [5]	91-053 368-21		
-265/02*	A	91-058 130-04	91-051 922-23 [5]	91-053 575-21	91-041 644-91	
-748/56-6/01*	BN 46	91-058 132-04	91-155 125-03			
-748/56-34/01*	AN 46	91-058 130-04	91-157 866-03			

Unterklassen-Übersicht/Table of subclasses/Table des sous-classes/Tabla de subclases

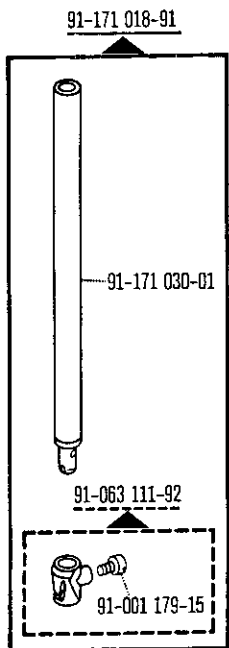

-6/01  
-32/21  
-34/01  
-72/03  
-230/81  
-265/01  
-265/02  
-748/56-6/01  
-748/56-34/01

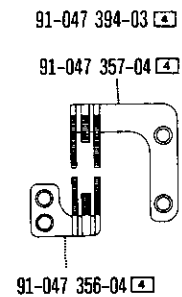

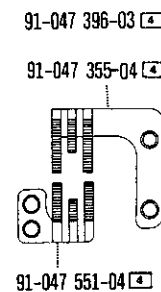

-32/21  
-34/01  
-72/03  
-265/0  
-265/0  
-748/51

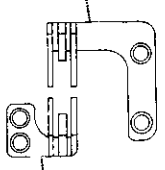
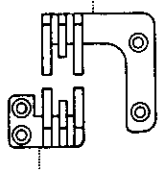
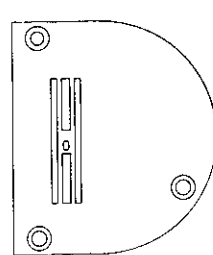
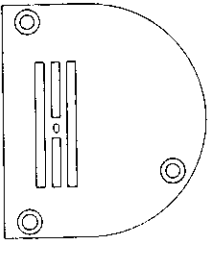
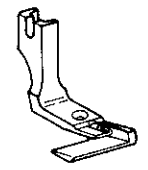

-6/01  
-230/81  
-748/51

Unterklassen-Ubersicht/ Table of subclasses/ Table des sous-classes/ Tabla de subclases

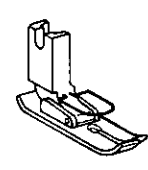
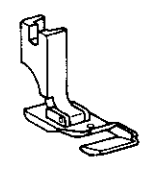
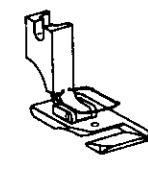
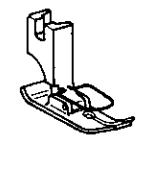
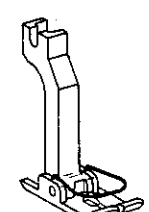
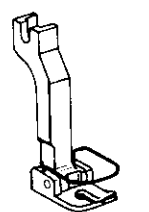
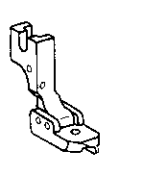
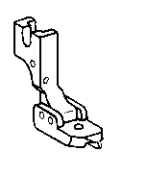
<p>91-047 781-00 </p> <p>91-047 782-05 </p>  <p>91-047 783-05 </p> <p>-32/21 -34/01 -72/03 -265/01 -265/02</p>	<p>91-047 784-00 </p> <p>91-047 786-05 </p>  <p>91-047 785-05 </p> <p>-6/01 -230/81 -748/56-6/01 -748/56-34/01</p>		
<p>91-058 130-04 </p>  <p>-32/21 -34/01 -72/03 -265/01 -265/02 -748/56-34/01</p>	<p>91-058 132-04 </p>  <p>-6/01 -230/81 -748/56-6/01</p>		
		<p>91-051 922-23  </p>  <p>-265/01 -265/02</p>	<p>91-051 997-01</p>  <p>-32/21 -72/03</p>
<p>91-054 004-03 </p>  <p>-6/01</p>	<p>91-054 012-03  </p>  <p>-6/01</p>	<p>91-054 051-03  </p>  <p>-34/01</p>	<p>91-054 084-03 </p>  <p>-34/01</p>
<p>91-155 125-03 </p>  <p>-748/56-6/01</p>	<p>91-157 866-03 </p>  <p>-748/56-34/01</p>	<p>99-117 802-91</p>  <p>-230/81</p>	<p>99-117 803-91</p>  <p>-230/81</p>

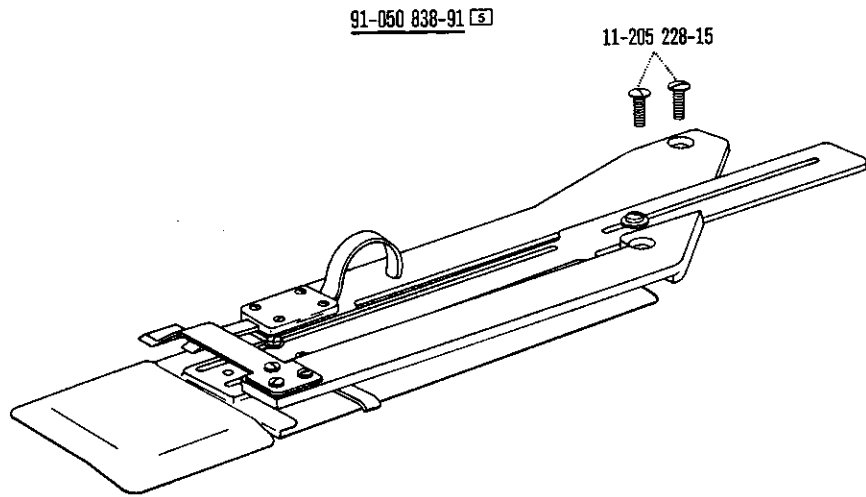

91-050 838-91 [5]

11-205 228-15

-72/0

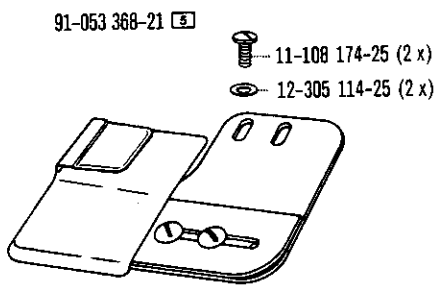

91-053 368-21 [5]

11-108 174-25 (2 x)

12-305 114-25 (2 x)

-265/01

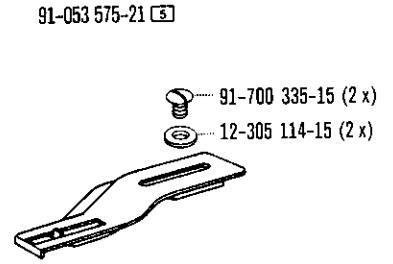

91-053 575-21 [5]

91-700 335-15 (2 x)

12-305 114-15 (2 x)

-265/0

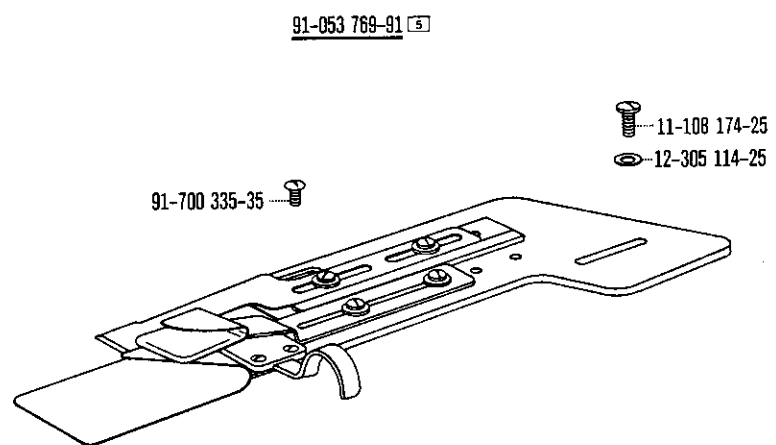

91-053 769-91 [5]

91-700 335-35

11-108 174-25

12-305 114-25

-32/1

91-041 644-91

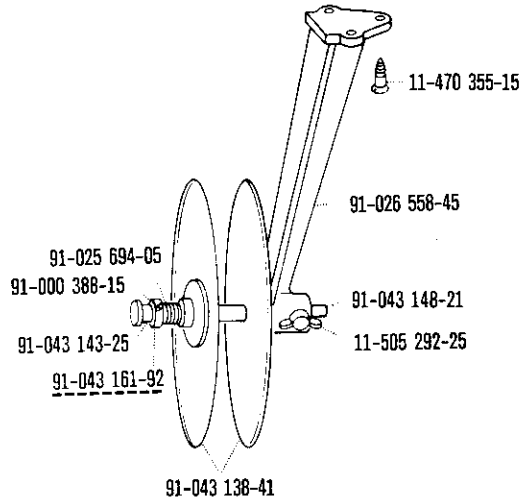

-265/02

91-056 553-92

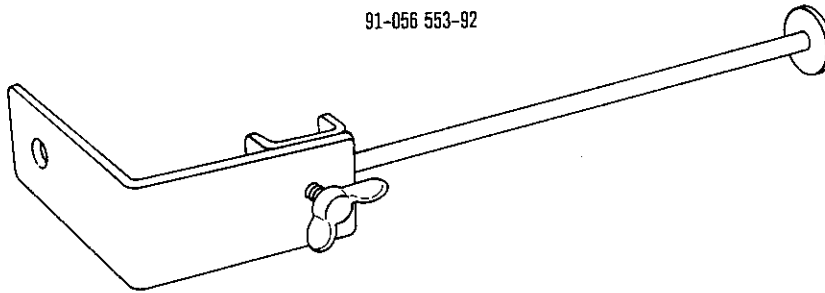

-72/03

91-053 953-21

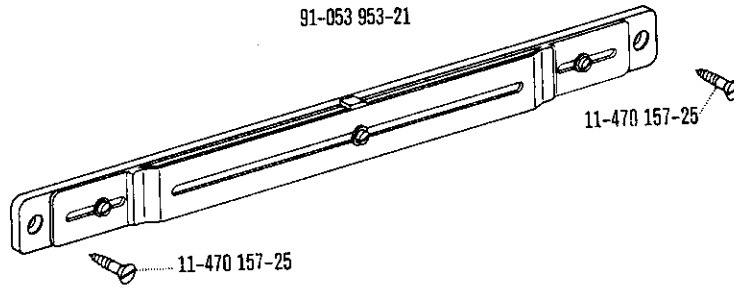

-72/03

Pfaff, D 6750 Kaiserslautern, Postfach 3020/3040, Telefon (0631) 200-0, Telex: 45753, Telefax (0631) 17202