

PFAFF

438

Unterklassen-Ausstattung
Subclass parts
Composition des sous-classes
Composición de las subclases

Unterklassen-Ausstattung¹⁾

Subclass organization¹⁾

Équipement des sous-classes¹⁾

Dotación de las subclases¹⁾

Unterklasse Subclass Sous-classe Subclase	Ausführung Model Version Tipo de máquina	Überstichbreite in mm Stitch width in mm Jetée de l'aiguille en mm Anchura del zigzag en mm	Nadelstange Needle bar Barre à aiguille Barra de aguja	Stoffschaber ⁴⁾ Feed dog Griffe Transportador inferior	Stichplatte ⁵⁾ Needle plate Plaque à aiguille Placa de aguja
6/01* ^{32/0}	A; B	4,5	91-168 019-91	91-047 666-04	91-058 035-04 ^{11/2}
-6/01* ^{39/0}	A; B	6,0	91-168 019-91	91-047 343-04	91-058 034-04
-6/01 N2,5*	A; B	4,5	91-168 019-91	91-047 576-04	91-058 114-04 ^{11/2}
-6/01 N2,5*	A; B	6,0	91-168 019-91	91-047 575-04	91-058 113-04
-6/01-915/05 ¹⁰ = 4,5 mm	A; B		91-167 809-91	91-047 570-04	91-058 086-04 ^{11/2}
-6/01-915/05 ¹⁰ = 6 mm	A; B		91-167 809-91	91-047 678-04	91-058 252-04
-6/21* ^{30/0}	A; B	4,5	91-168 019-91	91-047 570-04	91-058 086-04 ^{11/2}
-6/21* ^{30/0}	A; B	6,0	91-168 019-91	91-047 678-04	91-058 252-04
-6/21 N2,5*	A; B	4,5	91-168 019-91	91-047 691-04	91-058 257-04 ^{11/2}
-6/21 N2,5*	A; B	6,0	91-168 019-91	91-047 703-04	91-058 283-04
-17/31*	A; B	4,5	91-168 019-91	91-047 764-04	91-058 370-04
-17/31*	A; B	6,0	91-168 019-91	91-047 766-04	91-058 381-04
-17/71-905/05* ^{30/0}	B	6,0	91-168 019-91	91-493 039-04	91-493 040-04
-19/51* ¹³ = 1,5 - 3 mm	A; B	4,5	91-168 019-91	91-047 706-04	91-058 281-04
-19/51* ¹³ = 4 - 8 mm	A; B	4,5	91-168 019-91	91-047 705-04	91-058 280-04
-19/54 N2,5* ¹³ = 1; 1,5; 2 mm	A	3,0	91-168 019-91	91-047 588-04	91-058 140-04
-32/01*	A; B	4,5	91-168 019-91	91-047 666-04	91-058 035-04 ^{11/2}
-34/01* ^{30/0}	A; B	3,0	91-168 019-91	91-047 587-04	91-058 139-04
-34/01 N2,5*	A	3,0	91-168 019-91	91-047 588-04	91-058 140-04
-34/01* ^{39/0}	A; B	4,5	91-168 019-91	91-047 666-04	91-058 217-04
-34/01 N2,5*	A	4,5	91-168 019-91	91-047 653-04	91-058 211-04
-39/31*	A; B	4,5	91-168 019-91	91-047 764-04	91-058 370-04
-39/31*	A; B	6,0	91-168 019-91	91-047 766-04	91-058 381-04
-39/81 N2,5* ^{30/0}	A; B	6,0	91-168 019-91	91-047 868-04	91-058 580-04
-44/01 N0,5*	A; B	4,5	91-168 019-91	91-047 657-04	91-058 213-04
-44/01 N0,5*	A; B	6,0	91-168 019-91	91-047 654-04	91-058 212-04
-44/12 N0,5*	A; B	3,0	91-168 019-91	91-047 657-04	91-058 213-04
-44/13 N0,5*	A; B	4,5	91-168 019-91	91-047 657-04	91-058 213-04
-44/13 N0,5*	A; B	6,0	91-168 019-91	91-047 654-04	91-058 212-04
-44/42-915/05 N0,5	A	6,0	91-167 809-91	91-047 654-04	91-058 212-04

¹⁾ Die Liste enthält nur Nähwerkzeuge und Apparate. Beim Umbau in eine andere Unterklasse oder Ausführung sind auch noch Maschinenteile erforderlich. Geben Sie also bei Bestellungen die genaue Bezeichnung der vorhandenen und der gewünschten Ausführung bekannt.

¹⁾ This list contains sewing parts and attachments only. When converting to another subclass or version, machine parts are also necessary. When ordering please therefore indicate exactly the existing version and the one required.

¹⁾ Cette liste ne contient que les organes de couture et les guides. En cas de transformation en une sous-classe ou variante différente, il faut utiliser aussi certaines pièces de machine supplémentaires. En cas de commande, prière de toujours indiquer par conséquent les variantes disponibles et souhaitées.

¹⁾ Esta lista sólo contiene elementos de costura y aparatos. Siempre que haya que transformar la máquina en otro tipo o subclase, se necesitarán también piezas de máquina, por lo que deberá indicarse en los pedidos el tipo exacto de que se dispone y el deseado.

⁴⁾ = Ausführung angeben
= Indicate model
= Préciser la version
= Indiquez el tipo de máquina

⁵⁾ = Nähmuster einsenden
= Submit sewing sample
= Joindre échantillons de couture
= Envíese muestra de costura

¹⁰⁾ = Nadelabstand
= Needle gauge
= Écartement des aiguilles
= Distancia entre agujas

^{11/2)} = Überstichbreite bei Bestellung angeben
= Indicate max. stitch width on order
= Indiquer jetée d'aiguille à la commande
= Indiquez el ancho de zigzag en los pedidos

Equipement des sous-classes¹⁾
 Unterklassen-Ausstattung¹⁾

Dotación de las subclases¹⁾
 Subclass organization¹⁾

Unterklasse Subclass Sous-classe Subclase	Ausführung Model Version Tipo de máquina	Nähfuß Presser foot Pied presseur Pie prensateelas	Apparat Attachment Appareil Aparato	Träger Bracket Support Soporte	Beführung Tape guide Guide-ruban Guiachitas	Bandrollenträger Tape reel bracket Piseteau dérouleur Portarrollos	Führungsbügel Guide wire Pisate-fil Gula de alambre
6/01* ³⁰⁰	A; B	91-054 504-03					
6/01* ³⁰⁰	A; B	91-054 501-03					
6/01 N2,5*	A; B	91-054 504-03					
6/01 N2,5*	A; B	91-054 501-03					
6/01-915/05 ¹⁰ = 4,5 mm	A; B	91-054 504-03					
6/01-915/05 ¹⁰ = 6 mm	A; B	91-054 501-03					
6/21* ³⁰⁰	A; B	91-054 504-03					
6/21* ³⁰⁰	A; B	91-054 501-03					
6/21 N2,5*	A; B	91-054 504-03					
6/21 N2,5*	A; B	91-054 501-03					
17/31*	A; B	91-055 056-03 ¹¹⁷	91-050 960-23		91-040 392-21		
17/31*	A; B	91-055 056-03 ¹¹⁷	91-050 960-23		91-040 392-21		
17/71-905/05* ³⁰⁰	B	91-493 041-04 ¹¹⁷	91-485 437-23	91-494 443-25	91-494 306-23	91-046 211-91	
19/51* ¹³ = 1,5 - 3 mm	A; B	91-052 021-93 ³					
19/51* ¹³ = 4 - 8 mm	A; B	91-052 021-93 ³					
19/54 N2,5* ¹³ = 1; 1,5; 2 mm	A	91-052 023-93 ³					
32/01*	A; B	91-054 534-93					
34/01* ³⁰⁰	A; B	91-055 030-03					
34/01 N2,5*	A	91-055 030-03					
34/01* ³⁰⁰	A; B	91-055 112-03					
34/01 N2,5*	A	91-055 112-03					
39/31*	A; B	91-055 056-03 ¹¹⁷	91-050 961-93				
39/31*	A; B	91-055 056-03 ¹¹⁷	91-050 961-93				
39/81 N2,5* ³⁰⁰	A; B	91-494 181-93	91-053 674-23	91-056 116-90			
44/01 N0,5*	A; B	91-055 114-93 ¹¹⁷					
44/01 N0,5*	A; B	91-055 114-93 ¹¹⁷					
44/12 N0,5*	A; B	91-054 945-03					91-168 034-15
44/13 N0,5*	A; B	91-054 938-93					
44/13 N0,5*	A; B	91-493 704-03					
44/42-915/05 N0,5	A	91-460 722-93x0,8 ⁸⁰ 91-460 724-93x1,2 ⁸⁰				91-156 075-91	91-168 878-15

¹⁾ Unterklasse kann mit Faden-
 durchzieh- und -abschneidein-
 richtung -900/51 geliefert wer-
 den; dabei bleiben die
 aufgeführten Bestellnummern
 unverändert.

¹⁾ Subclass can be supplied with
 thread puller/trimmer -900/51;
 in this case the ordering
 numbers listed remain
 unchanged.

¹⁾ Sous-classe livrable avec
 coupe-fil -900/51; les numéros
 de commande restent inchan-
 gés.

¹⁾ La subclase se puede
 suministrar con el cort
 los automático -900/5
 permaneciendo invari
 los números de pedid
 dicados.

³⁰⁰ = nicht mehr im Programm;
 jedoch Ersatzteile lieferbar
 = No longer part of production range;
 substitute available
 = Rayé du programme; pièces détachées
 toutefois livrables
 = Fuera de programa; las piezas de recambio,
 no obstante, se siguen suministrando.

¹³ = Saumbreite
 = Hem width
 = Largeur de l'ourlet
 = Anchura del dobladillo

⁸⁰ = Wahlweise
 = Optional
 = Au choix
 = Opcional

Fortsetzung siehe nächste Seite
 Continued on next page
 Suite voir page suivante
 Continúa en la página siguiente



Unterklassen-Ausstattung¹⁾

Equipement des sous-classes¹⁾

Subclass organization¹⁾

Dotación de las subclases¹⁾

Unterklasse Subclass Sous-classe Subclase	Ausführung Model Version Tipo de máquina	Überstichbreite in mm Slitch width in mm Jetée de l'aiguille en mm Anchura del zigzag en mm	Nadelstange Needle bar Barre à aiguille Barra de aguja	Stoffschieber ⁴⁾ Feed dog Griffe Transportador inferior	Stichplatte ⁴⁾ Needle plate Plaque à aiguille Pieza de aguja	Stichplatteneinsatz Needle plate insert Applique de plaque Aplicativo de la placa de aguja
-45/01-915/05* ¹⁰ = 3 mm	A; B		91-167 809-91	91-047 570-04	91-058 253-04 ^{11/2}	91-026 900-14 ^{20/2}
-45/01-915/05* ¹⁰ = 4,5 mm	A; B		91-167 809-91	91-047 570-04	91-058 253-04 ^{10/2}	91-026 900-14 ^{20/2}
-45/01-915/05 ¹⁰ = 6 mm	A; B		91-167 809-91	91-047 678-04	91-058 254-04	91-026 900-14 ^{20/2}
-45/02-915/05* ¹⁰ = 3 mm	A; B		91-167 809-91	91-047 570-04	91-058 253-04 ^{10/2}	91-026 904-14 ^{21/2}
-45/02-915/05* ¹⁰ = 4,5 mm	A; B		91-167 809-91	91-047 570-04	91-058 253-04 ^{10/2}	91-026 904-14 ^{21/2}
-45/02-915/05 ¹⁰ = 6 mm	A; B		91-167 809-91	91-047 678-04	91-058 254-04	91-026 904-14 ^{21/2}
-47/01*	A; B	4,5	91-168 019-91	91-059 565-04	91-058 832-04	
-47/11* ^{30/0}	A; B	6,0	91-168 019-91	91-047 868-04	91-058 580-04	
-53/01*	B	4,5	91-168 019-91	91-047 706-04	91-058 281-04	
-55/01*	A; B	4,5	91-168 019-91	91-047 751-04	91-058 363-04 ^{11/2}	
-55/01*	A; B	6,0	91-168 019-91	91-047 751-04	91-058 363-04 ^{11/2}	
-61/04 N2,5* ^{30/0}	A; B	4,5	91-168 019-91	91-047 576-04	91-058 114-04 ^{11/2}	
-61/04 N2,5*	A; B	6,0	91-168 019-91	91-047 576-04	91-058 113-04	
-139/01 N2,5*	A; B	3,0	91-168 019-91	91-047 691-04	91-058 257-04 ^{11/2}	
-139/02 N2,5*	A; B	3,0	91-168 019-91	91-047 691-04	91-058 257-04 ^{11/2}	
-195/02 N2,5*	A; B	6,0	91-168 019-91	91-047 575-04	91-058 113-04	
-358/01-918/01*	B	2,0	91-168 019-91	91-047 719-04	91-058 298-04	

1) Die Liste enthält nur Nähwerkzeuge und Apparate. Beim Umbau in eine andere Unterklasse oder Ausführung sind auch noch Maschinenteile erforderlich. Geben Sie also bei Bestellungen die genaue Bezeichnung der vorhandenen und der gewünschten Ausführung bekannt.

1) This list contains sewing parts and attachments only. When converting to another subclass or version, machine parts are also necessary. When ordering please therefore indicate exactly the existing version and the one required.

1) Cette liste ne contient que les organes de couture et les guides. En cas de transformation en une sous-classe ou variante différente, il faut utiliser aussi certaines pièces de machine supplémentaires. En cas de commande, prière de toujours indiquer par conséquent les variantes disponibles et souhaitées.

1) Esta lista sólo contiene elementos de costura y aparatos. Siempre que haya que transformar la máquina en otro tipo o subclase, se necesitarán también piezas de máquina, por lo que deberá indicarse en los pedidos el tipo exacto de que se dispone y el deseado.

⁴⁾ = Ausführung angeben
= Indicate model
= Préciser la version
= Indíquese el tipo de máquina

⁵⁾ = Nähmuster einsenden
= Submit sewing sample
= Joindre échantillons de couture
= Envíese muestra de costura

¹⁰⁾ = Nadelabstand
= Needle gauge
= Écartement des aiguilles
= Distancia entre agujas

^{10/2)} = Nadelabstand bei Bestellung angeben
= State needle gauge on order
= Indiquer écartement des aiguilles à la commande
= Indíquese la distancia entre agujas en los pedidos

^{11/2)} = Überstichbreite bei Bestellung angeben
= Indicate max. stitch width on order
= Indiquer jetée d'aiguille à la commande
= Indíquese el ancho de zigzag en los pedidos

¹⁸⁾ = Biesenbreite
= Cording width
= Largeur de la nervure
= Anchura de la alforza

Equipement des sous-classes¹⁾
 Unterklassen-Ausstattung¹⁾

Dotación de las subclases¹⁾
 Subclass organization¹⁾

Unterklasse Subclass Sous-classe Subclase	Ausführung Model Version Tipo de máquina	Mühlaufl. Presserfoot Pie presser Pie prensateelas	Apparat Attachement Appareil Aparato	Träger Bracket Support Soporte	Lineal Edge guide Guía-borde Guía recta	Bandrollenräger Tape reel bracket Plateau dérouleur Portarrollos
-45/01-915/05* 10 = 3 mm	A; B	91-055 099-93 19 = 1,6 mm 91-055 148-93 22 19 = 2 mm				
-45/01-915/05* 10 = 4,5 mm	A; B	91-055 147-93 19 = 2 mm 91-055 098-93 22 19 = 2 mm 91-055 150-93 22 19 = 2,8 mm				
-45/01-915/05 10 = 6 mm	A; B	91-055 149-93 19 = 2,8 mm 91-055 096-93 19 = 4 mm				
-45/02-915/05* 10 = 3 mm	A; B	91-055 099-93 19 = 1,6 mm 91-055 148-93 22 19 = 2 mm				
-45/02-915/05* 10 = 4,5 mm	A; B	91-055 147-93 19 = 2 mm 91-055 098-93 22 19 = 2,4 mm 91-055 150-93 22 19 = 2,8 mm				
-45/02-915/05 10 = 6 mm	A; B	91-055 149-93 19 = 2,8 mm 91-055 096-93 19 = 4 mm				
-47/01*	A; B	91-057 408-93 1172			91-026 862-91	
-47/11* 300	A; B	91-055 673-93			91-056 063-21	
-53/01*	B	91-055 176-03	91-041 858-23			
-55/01*	A; B	91-055 475-93 1172			91-040 998-25	
-55/01*	A; B	91-055 475-93 1172			91-040 998-25	
-61/04 N2,5* 300	A; B	91-055 142-93 3			91-055 141-25	91-040 207-91
-61/04 N2,5*	A; B	91-055 142-93 3			91-055 141-25	91-040 207-91
-139/01 N2,5*	A; B	91-050 329-91 3				
-139/02 N2,5*	A; B	91-050 328-91 3				
-195/02 N2,5*	A; B	91-494 181-93	91-494 369-23	91-753 936-90		
-358/01-918/01*	B	91-057 112-93	91-168 430-21			

¹⁾ Unterklasse kann mit Fadendurchzieh- und -abschneideinrichtung -900/51 geliefert werden; dabei bleiben die aufgeführten Bestellnummern unverändert.

¹⁾ Subclass can be supplied with thread puller/trimmer -900/51; in this case the ordering numbers listed remain unchanged.

¹⁾ Sous-classe livrable avec coupe-fil -900/51; les numéros de commande restent inchangés.

¹⁾ La subclase se puede suministrar con el cortahilos automático -900/51; permaneciendo invariables los números de pedido indicados.

207 = Bienenhöhe bei Bestellung angeben
 = Indicate cording height on order
 = Indiquer hauteur de nervure à la commande
 = Indiquese la altura de la nervadura en los pedidos

217 = Kordeldicke bei Bestellung angeben
 = State cord thickness on order
 = A la commande, préciser la grosseur du cordon
 = Indiquese el grosor del cordón en los pedidos

22 = Zubehör
 = Accessories
 = Accessoires
 = Accesorios

300 = nicht mehr im Programm; jedoch Ersatzteile lieferbar
 = No longer part of production range; substitute available
 = Rayé du programme; pièces détachées toutefois livrables
 = Fuera de programa; las piezas de recambio, no obstante, se siguen suministrando.

Fortsetzung siehe nächste Seite
 Continued on next page
 Suite voir page suivante
 Continúa en la página siguiente



Unterklassen-Ausstattung¹⁾

Subclass organization¹⁾

Equipement des sous-classes¹⁾

Dotación de las subclases¹⁾

Unterklasse Subclass Sous-classe Subclase	Ausführung Model Version Tipo de máquina	Überstichbreite in mm Sitch width in mm Jalée de l'aiguille en mm Anchura del zigzag en mm	Nadelstange Needle bar Barre à aiguille Barra de aguja	Stoffschieber ⁴⁾ Feed dog Griffe Transportador inferior	Stichplatte ⁴⁾ Needle plate Plaque à aiguille Placa de aguja	Niederhalter Work retainer Pied de maintien Pie de retención
-716/04-6/01 N2,5*	A; B	6,0	91-168 019-91	91-047 575-04	91-058 113-04	
-716/04-17/31 N2,5*	A; B	3,0; 4,5	91-168 019-91	91-047 764-04	91-058 370-04 ^{11/2)}	
-716/04-44/22 N2,5*	A; B	6,0	91-168 019-91	91-047 703-04	91-058 283-04	
-716/06-6/01 N2,5*	A; B	6,0	91-168 019-91	91-047 575-04	91-058 113-04	
-716/06-17/31 N2,5*	A; B	6,0	91-168 019-91	91-047 766-04	91-058 381-04	
-716/06-39/31 N2,5*	A; B	6,0	91-168 019-91	91-047 766-04	91-058 381-04	
-716/06-44/32 N2,5*	A; B	6,0	91-168 019-91	91-047 703-04	91-058 283-04	
-716/08-17/82 N2,5*	A	6,0	91-168 019-91	91-047 868-04	91-058 580-04	
-716/08-39/82 N2,5*	A	6,0	91-168 019-91	91-047 868-04	91-058 580-04	
-716/18-17/82 N2,5*	A	6,0	91-168 019-91	91-047 868-04	91-058 580-04	
-716/18-39/82 N2,5*	A	6,0	91-168 019-91	91-047 868-04	91-058 580-04	
-771/01-6/01 N2,5 ^{30/0} ^g = 1,5 mm	A	4,5	91-168 019-91	91-047 557-04	91-058 117-91	
-771/01-6/07 N2,5 ^{30/0} ^g = 1,5 mm	A	3,0	91-168 019-91	91-047 697-04	91-058 274-91	
-771/01-6/07 N2,5 ^{30/0} ^g = 2,2 mm	A	3,0	91-168 019-91	91-047 697-04	91-058 273-91	
-771/01 (/04)-6/21 N2,5* ^g = 1,5 mm	A	4,5	91-168 019-91	91-059 598-04	91-158 318-91	
-771/01 (/04)-6/27 N2,5* ^g = 1,5 mm	A	3,0	91-168 019-91	91-059 294-04	91-158 487-91	
-771/01-151/10 N2,5 ^{30/0} ^g = 1,5 mm	A	4,5	91-168 019-91	91-047 577-04	91-058 117-91	
-771/02-6/01 N2,5 ^{30/0} ^g = 2,2 mm	A	3,0	91-168 019-91	91-047 697-04	91-058 353-91	
-780/01-6/03-980/02 N2,5 A; B	A; B	4,5	91-168 019-91	91-059 349-04	91-158 647-93 ^{11/2)}	91-155 197-21

¹⁾ Die Liste enthält nur Nähwerkzeuge und Apparate. Beim Umbau in eine andere Unterklasse oder Ausführung sind auch noch Maschinenteile erforderlich. Geben Sie also bei Bestellungen die genaue Bezeichnung der vorhandenen und der gewünschten Ausführung bekannt.

¹⁾ This list contains sewing parts and attachments only. When converting to another subclass or version, machine parts are also necessary. When ordering please therefore indicate exactly the existing version and the one required.

¹⁾ Cette liste ne contient que les organes de couture et les guides. En cas de transformation en une sous-classe ou variante différente, il faut utiliser aussi certaines pièces de machine supplémentaires. En cas de commande, prière de toujours indiquer par conséquent les variantes disponibles et souhaitées.

¹⁾ Esta lista sólo contiene elementos de costura y aparatos. Siempre que haya que transformar la máquina en otro tipo o subclase, se necesitarán también piezas de máquina, por lo que deberá indicarse en los pedidos el tipo exacto de que se dispone y el deseado.

⁴⁾ = Ausführung angeben
= Indicate model
= Préciser la version
= Indiquese el tipo de máquina

^g = Nähmuster einsenden
= Submit sewing sample
= Joindre échantillons de couture
= Enviese muestra de costura

^g = Schneideabstand
= Trimming margin
= Distance de coupe
= Margen de corte

Equipement des sous-classes¹⁾

Dotación de las subclases¹⁾

Unterklassen-Ausstattung¹⁾

Subclass organization¹⁾

Unterklasse Subclasse Sub-classe Subclase	Ausführung Model Version Tipo de máquina	Nähfuß ²⁾ Presser foot Pie presseur Pie prensateelas	Apparat ³⁾ Atachment Apparat Aparato	Träger Bracket Support Soporte	Bandführung Tape guide Guide-ribben Guías cintas	Bandrollenträger Tape reel bracket Plateau dérouleur Portarrollos	Messer Knife Couteau Cuchilla
-716/04-6/01 N2,5*	A; B	91-054 501-03					
-716/04-17/31 N2,5*	A; B	91-055 056-03 ¹¹⁷²	91-050 960-23		91-040 392-21		
-716/04-44/22 N2,5*	A; B	91-055 809-93 ²¹⁷²					
-716/06-6/01 N2,5*	A; B	91-054 501-03					
-716/06-17/31 N2,5*	A; B	91-055 056-03 ¹¹⁷²	91-050 960-23		91-040 392-21		
-716/06-39/31 N2,5*	A; B	91-055 056-03 ¹¹⁷²	91-050 961-93		91-040 392-21		
-716/06-44/32 N2,5*	A; B	91-055 805-93 ²¹⁷²					
-716/08-17/82 N2,5*	A	91-055 985-93	91-056 106-23	91-056 109-25 91-056 116-90		91-043 943-91	
-716/08-39/82 N2,5*	A	91-055 985-93	91-056 075-23	91-056 109-25 91-056 116-90		91-043 943-91	
-716/18-17/82 N2,5*	A	91-055 965-93	91-056 106-23	91-056 109-25 91-056 116-90		91-043 943-91	
-716/18-39/82 N2,5*	A	91-055 965-93	91-056 075-23	91-056 109-25 91-056 116-90		91-043 943-91	
-771/01-6/01 N2,5 ³⁰⁷⁰ E = 1,5 mm	A	91-157 694-01					91-168 135-05 91-168 688-01
-771/01-6/07 N2,5 ³⁰⁷⁰ E = 1,5 mm	A	91-157 639-01					91-168 135-05 91-168 688-01
-771/01-6/07 N2,5 ³⁰⁷⁰ E = 2,2 mm	A	91-157 639-01					91-168 135-05 91-168 688-01
-771/01 (/04)-6/21 N2,5* E = 1,5 mm	A	91-157 694-01					91-167 973-05
-771/01 (/04)-6/27 N2,5* E = 1,5 mm	A	91-155 138-01					91-167 973-05
-771/01-151/10 N2,5 ³⁰⁷⁰ E = 1,5 mm	A	91-157 483-91					91-168 135-05 91-168 688-01
-771/02-6/01 N2,5 ³⁰⁷⁰ E = 2,2 mm	A	91-055 378-01					91-168 285-05 91-168 688-01
-780/01-6/03-980/02 N2,5	A; B	91-155 247-93					

¹⁾ Unterklasse kann mit Faden-durchzieh- und -abschneidein-richtung -900/51 geliefert werden; dabei bleiben die auf-geführten Bestellnummern un-verändert.

²⁾ Subclass can be supplied with thread puller/trimmer -900/51; in this case the ordering numbers listed remain unchanged.

³⁾ Sous-classe livrable avec coupe-fil -900/51; les numéros de commande restent inchan-gés.

⁴⁾ La subclase se puede suministrar con el cortah los automático -900/51; permaneciendo invariabl los números de pedido ir dicados.

¹¹⁷² = Überstichbreite bei Bestellung angeben
= indicate max. stitch width on order
= indiquer jetée d'aiguille à la commande
= Indiquese el ancho de zigzag en los pedidos

²¹⁷² = Kordeldicke bei Bestellung angeben
= State cord thickness on order
= A la commande, préciser la grosseur du cordon
= Indiquese el grosor del cordón en los pedidos

³⁰⁷⁰ = nicht mehr im Programm; jedoch Ersatzteile lieferbar
= No longer part of production range; substitute available
= Rayé du programme; pièces détachées toutefois livrables
= Fuera de programa; las piezas de recambio, no obstante, se siguen suministrando.

Unterklassen-Übersicht/Table of subclasses/Table des sous-classes/Tabla de subclasses

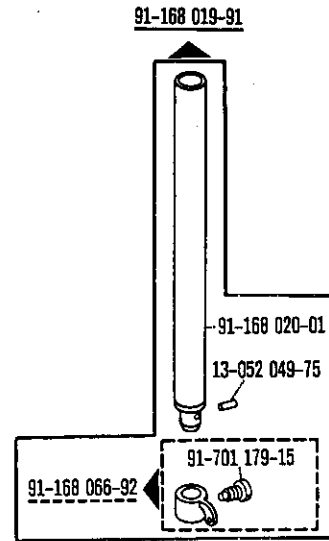
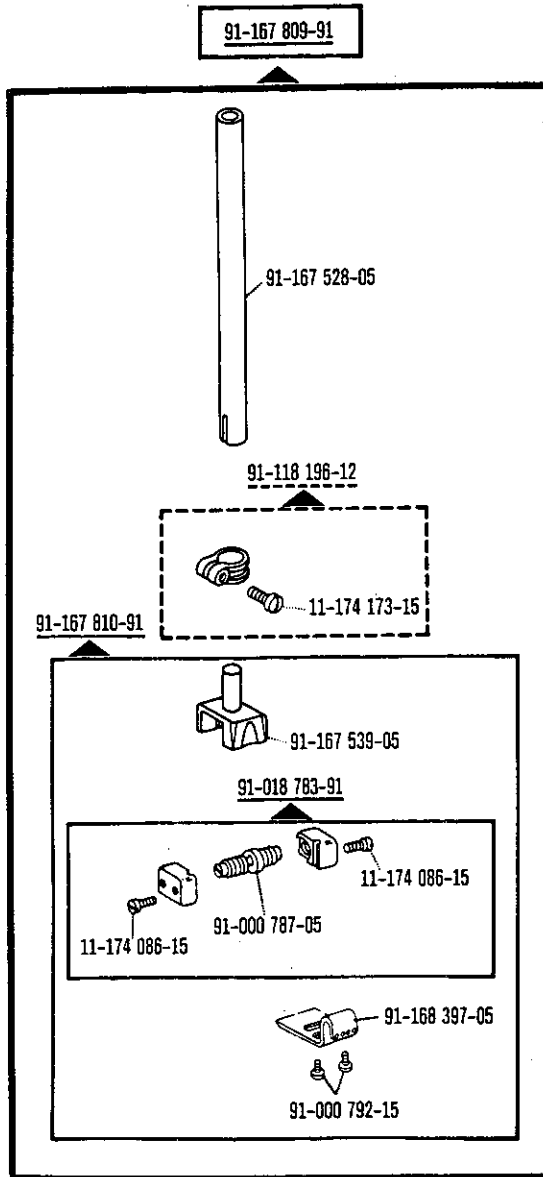

-6/01-915/05
 -44/42-915/05 N0,5
 -45/01-915/05
 -45/02-915/05

-6/01
 -6/01 N2,5
 -6/21
 -6/21 N2,5
 -17/31
 -17/71-905/05
 -19/51
 -19/54 N2,5
 -32/01
 -34/01
 -34/01 N2,5
 -39/31
 -39/81 N2,5
 -44/01 N0,5
 -44/12 N0,5
 -44/13 N0,5
 -47/01
 -47/11
 -53/01
 -55/01
 -61/04 N2,5

-139/01 N2,5
 -139/02 N2,5
 -195/02 N2,5
 -358/01-918/01
 -716/04-6/01 N2,5
 -716/04-17/31 N2,5
 -716/04-44/22 N2,5
 -716/06-6/01 N2,5
 -716/06-17/31 N2,5
 -716/06-39/31 N2,5
 -716/06-44/32 N2,5
 -716/08-17/82 N2,5
 -716/08-39/82 N2,5
 -716/18-17/82 N2,5
 -716/18-39/82 N2,5
 -771/01-6/01 N2,5
 -771/01-6/07 N2,5
 -771/01 (/04)-6/21 N2,5
 -771/01 (/04)-6/27 N2,5
 -771/01-151/10 N2,5
 -771/02-6/01 N2,5
 -780/01-6/03-980/02 N2,5

Unterklassen-Übersicht/Table of subclasses/Table des sous-classes/Tabla de subclasses

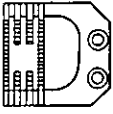
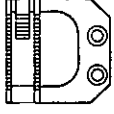
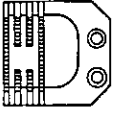
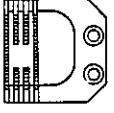
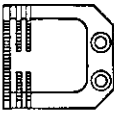
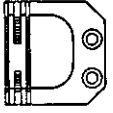
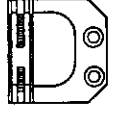
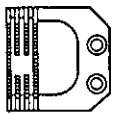
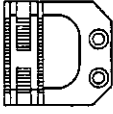
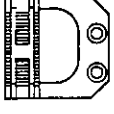
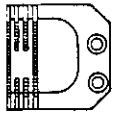
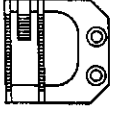
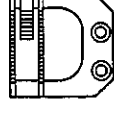
<p>91-047 343-04 </p>	<p>91-047 570-04 </p> <p>-6/01-915/05 -6/21 -45/01-915/05 -45/02-915/05</p>	
<p>91-047 575-04 </p> <p>-6/01 N2,5 -61/04 N2,5 -195/02 N2,5 -716/04-6/01 N2,5 -716/06-6/01 N2,5</p>	<p>91-047 576-04 </p> <p>-6/01 N2,5 -61/04 N2,5</p>	
<p>91-047 577-04 </p> <p>-771/01-6/01 N2,5 -771/01-151/10 N2,5</p>	<p>91-047 587-04 </p> <p>-34/01</p>	<p>91-047 588-04 </p> <p>-19/54 N2,5 -34/01 N2,5</p>
<p>91-047 653-04 </p> <p>-34/01 N2,5</p>	<p>91-047 654-04 </p> <p>-44/01 N0,5 -44/13 N0,5 -44/42-915/05 N0,5</p>	<p>91-047 657-04 </p> <p>-44/01 N0,5 -44/12 N0,5 -44/13 N0,5</p>
<p>91-047 666-04 </p> <p>-6/01 -32/01 -34/01</p>	<p>91-047 678-04 </p> <p>-6/01-915/05 -6/21 -45/01-915/05 -45/02-915/05</p>	<p>91-047 691-04 </p> <p>-6/21 N2,5 -139/01 N2,5 -139/02 N2,5</p>

Unterklassen-Ubersicht/ Table of subclasses/ I abie des sous-classes/ I abia de suoclass

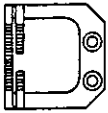
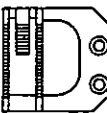
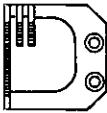
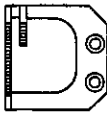
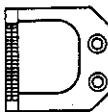
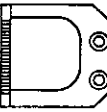
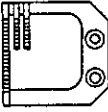
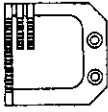
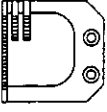
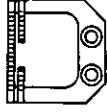
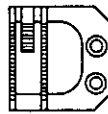
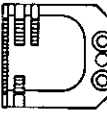
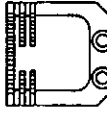
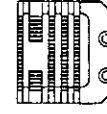
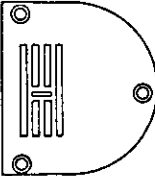
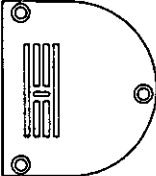
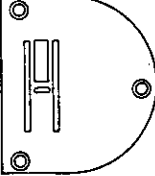

<p>91-047 697-04 </p> <p>-771/01-6/07 N2,5 -771/02-6/01 N2,5</p>	<p>91-047 703-04 </p> <p>-6/21 N2,5 -716/04-44/22 N 2,5 -716/06-44/32 N2,5</p>	<p>91-047 705-04 </p> <p>-19/51</p>	<p>91-047 706-04 </p> <p>-19/51 -53/01</p>	
<p>91-047 719-04 </p> <p>-358/01-918/01</p>	<p>91-047 751-04 </p> <p>-55/01</p>	<p>91-047 764-04 </p> <p>-17/31 -39/31 -716/04-17/31 N2,5</p>		
<p>91-047 766-04 </p> <p>-17/31 -39/31 -716/06-17/31 N2,5 -716/06-39/31 N2,5</p>	<p>91-047 868-04 </p> <p>-39/81 N2,5 -47/11 -716/08-17/82 N2,5 -716/08-39/82 N2,5 -716/18-17/82 N2,5 -716/18-39/82 N2,5</p>		<p>91-059 294-04 </p> <p>-771/01 (/04) -6/27 N2,5</p>	
<p>91-059 349-04 </p> <p>-780/01-6/03-980/02</p>	<p>91-059 565-04 </p> <p>-47/01</p>	<p>91-059 598-04 </p> <p>-771/01 (/04) -6/21 N2,5</p>	<p>91-493 039-04 </p> <p>-17/71-905/05</p>	
		<p>91-058 034-04 </p> <p>-6/01</p>	<p>91-058 035-04 </p> <p>-6/01 -32/01</p>	<p>91-058 086-04 </p> <p>-6/01-915/05 -6/21</p>

Unterklassen-Übersicht/ Table of subclasses/ Table des sous-classes/ Tabla de subclasses

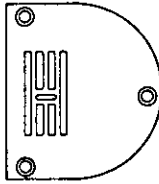
91-058 113-04 



-6/01 N2,5
-61/04 N2,5
-195/02 N2,5
-716/04-6/01 N2,5
-716/06-6/01 N2,5

91-058 114-04  

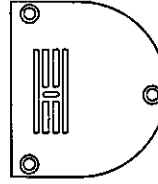

-6/01 N2,5
-61/04 N2,5

91-058 117-91

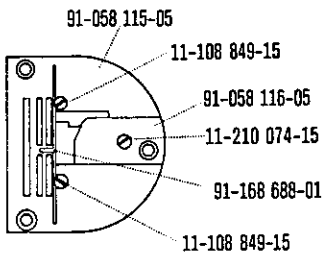

-771/01-6/01 N2,5
-771/01-151/10 N2,5

91-058 139-04 

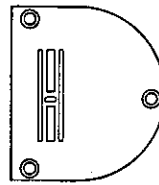

-34/01

91-058 140-04 

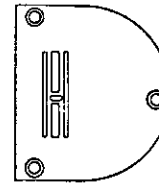

-19/54 N2,5
-34/01 N2,5

91-058 211-04 

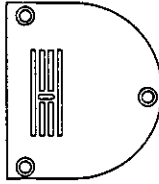

-34/01 N2,5

91-058 212-04 

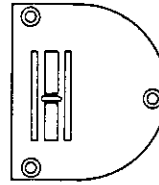

-44/01 N0,5
-44/13 N0,5
-44/42-915/05 N0,5

91-058 213-04 

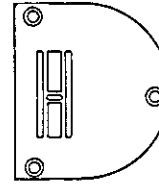

-44/01 N0,5
-44/12 N0,5
-44/13 N0,5

91-058 217-04 

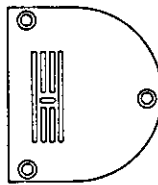

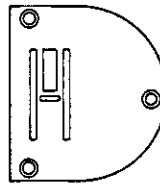

-34/01

91-058 252-04 



-6/01-915/05
-6/21

91-058 253-04  

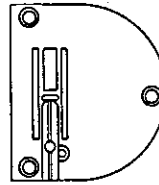

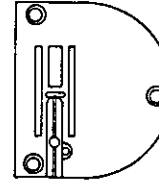

-45/01-915/05
-45/02-915/05

91-058 254-04 



-45/01-915/05
-45/02-915/05

91-058 257-04  

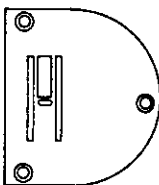





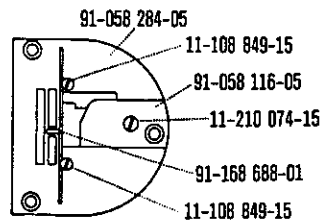





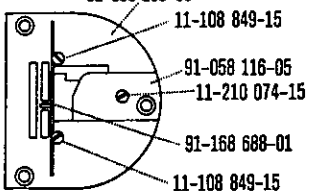

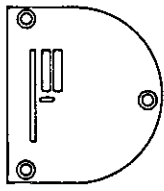

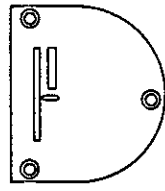

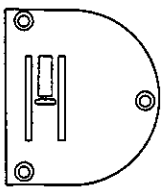

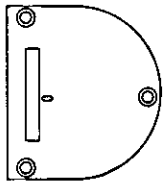
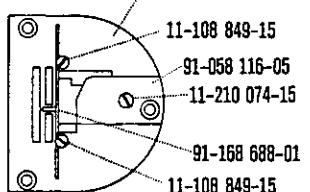
-6/21 N2,5
-139/01 N2,5
-139/02 N2,5

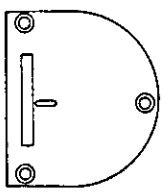
91-058 273-91

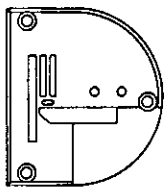

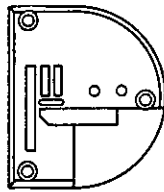

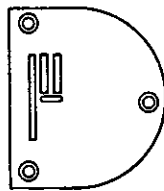

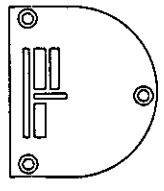
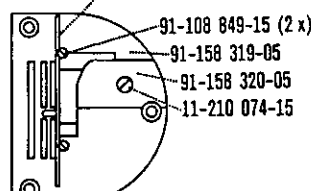
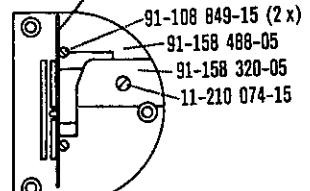





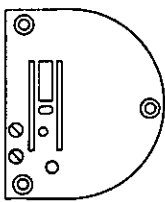

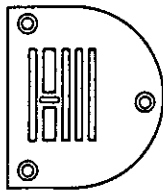





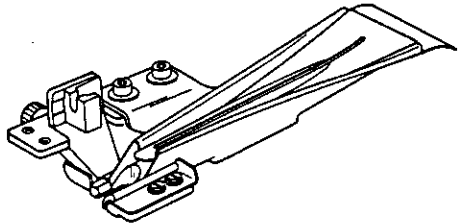

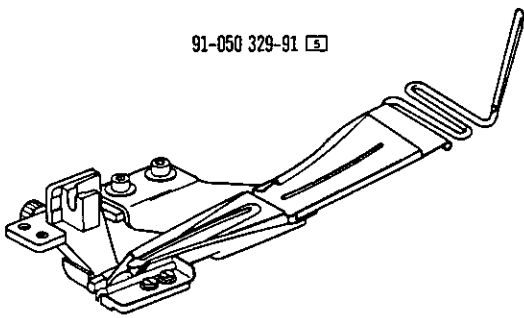

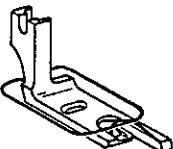



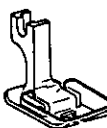

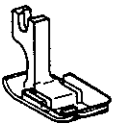

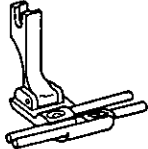

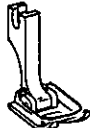
-771/01-6/07 N2,5

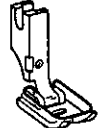









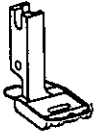

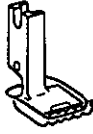

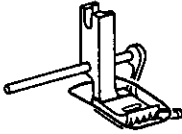





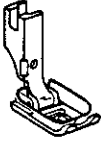



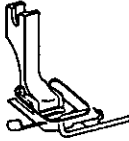

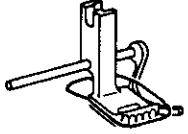

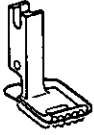

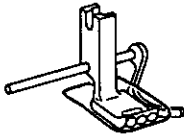
Unterklassen-Ubersicht/ Table of subclasses/ I able des sous-classes/ I abla de subciases

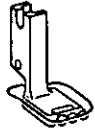
<p>91-058 274-91</p>  <p>-771/01-6/07 N2,5</p>	<p>91-058 280-04 </p>  <p>-19/51</p>	<p>91-058 281-04 </p>  <p>-19/51 -53/01</p>
<p>91-058 283-04 </p>  <p>-6/21 N2,5 -716/04-44/22 N2,5 -716/06-44/32 N2,5</p>	<p>91-058 298-04 </p>  <p>-358/01-918/01</p>	<p>91-058 353-91</p>  <p>-771/02-6/01 N2,5</p>
<p>91-058 363-04  </p>  <p>-55/01</p>	<p>91-058 370-04  </p>  <p>-17/31 -39/31 -716/04-17/31 N2,5</p>	<p>91-058 381-04 </p>  <p>-17/31 -39/31 -716/06-17/31 N2,5 -716/06-39/31 N2,5</p>
<p>91-058 580-04 </p>  <p>-39/81 N2,5 -47/11 -716/08-17/82 N2,5 -716/08-39/82 N2,5 -716/18-17/82 N2,5 -716/18-39/82 N2,5</p>	<p>91-058 832-04 </p>  <p>-47/01</p>	
<p>91-158 318-91</p>  <p>-771/01 (/04) -6/21 N2,5</p>	<p>91-158 487-91</p>  <p>-771/01 (/04) -6/27 N2,5</p>	

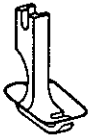



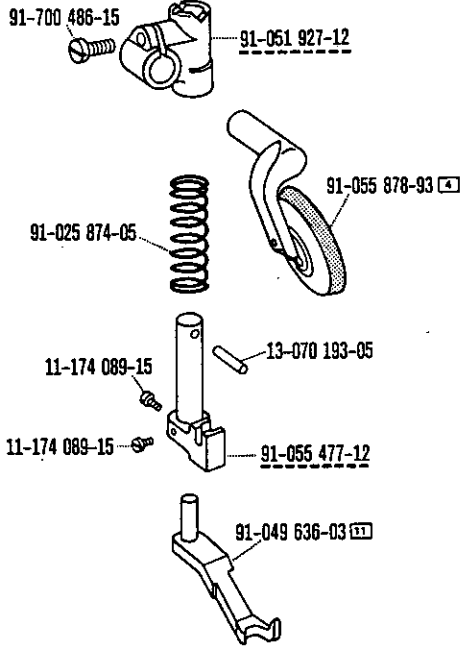













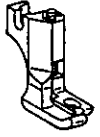

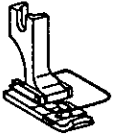
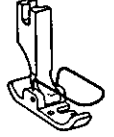

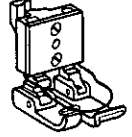
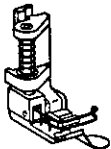
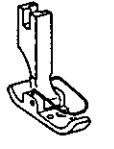
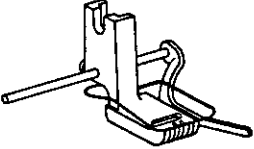
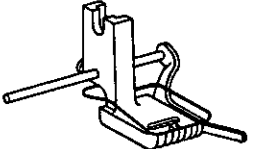
Unterklassen-Übersicht/Table of subclasses/Table des sous-classes/Tabla de subclasses

<p>91-158 647-93  </p>  <p>-780/01-6/03-980/02</p>	<p>91-493 040-04 </p>  <p>-17/71-905/05</p>	<p>91-026 900-14 </p>  <p>91-100 265-15</p> <p>-45/01-915/05</p>	<p>91-026 904-14 </p>  <p>91-100 265-15</p> <p>-45/02-915/05</p>
<p>91-050 328-91 </p>  <p>-139/02 N2,5</p>		<p>91-050 329-91 </p>  <p>-139/01 N2,5</p>	
<p>91-052 021-93  </p>  <p>-19/51</p>	<p>91-052 023-93  </p>  <p>-19/54 N2,5</p>	<p>91-054 501-03 </p> 	<p>-6/01 -6/01 N2,5 -6/01-915/05 -6/21 -6/21 N2,5 -716/04-6/01 N2,5 -716/06-6/01 N2,5</p>
<p>91-054 504-03 </p>  <p>-6/01 -6/01 N2,5 -6/01-915/05 -6/21 -6/21 N2,5</p>	<p>91-054 534-93 </p>  <p>-32/01</p>	<p>91-054 938-93 </p>  <p>-44/13 N0,5</p>	<p>91-054 945-03 </p>  <p>-44/12 N0,5</p>
<p>91-055 030-03 </p>  <p>-34/01 -34/01 N0,5</p>	<p>91-055 056-03  </p>  <p>-17/31 -39/31 -716/04-17/31 N2,5 -716/06-17/31 N2,5 -716/06-39/31 N2,5</p>		

Unterklassen-Übersicht/ Table of subclasses/ Table des sous-classes/ Tabla de subclasses

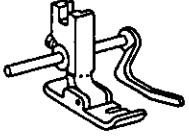
<p>91-055 096-93 </p>  <p>-45/01-915/05 -45/02-915/05</p>	<p>91-055 098-93 </p>  <p>-45/01-915/05 -45/02-915/05</p>	<p>91-055 099-93 </p>  <p>-45/01-915/05 -45/02-915/05</p>	<p>91-055 112-03 </p>  <p>-34/01 -34/01 N2,5</p>
<p>91-055 114-93   </p>  <p>-44/01 N0,5 -44/12 N0,5</p>	<p>91-055 142-93   </p>  <p>-61/04 N2,5</p>		<p>91-055 147-93 </p>  <p>-45/01-915/05 -45/02-915/05</p>
<p>91-055 148-93 </p>  <p>-45/01-915/05 -45/02-915/05</p>	<p>91-055 149-93 </p>  <p>-45/01-915/05 -45/02-915/05</p>	<p>91-055 150-93 </p>  <p>-45/01-915/05 -45/02-915/05</p>	<p>91-055 176-03 </p>  <p>-53/01</p>
<p>91-055 378-01</p>  <p>-771/02-8/01 N2,5</p>		<p>91-055 475-93  </p> 	
<p>91-055 673-93 </p>  <p>-47/11</p>		<p>-55/01</p>	

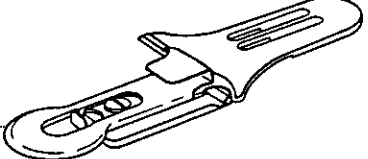
Unterklassen-Übersicht/ Table of subclasses/ Table des sous-classes/ Tabla de subclasses

<p>91-055 805-93  </p>  <p>-716/06-44/32 N2,5</p>	<p>91-055 809-93  </p>  <p>-716/04-44/22 N2,5</p>	<p>91-055 965-93 </p> 	<p>-716/08-17/82 N2,5 -716/08-39/82 N2,5 -716/18-17/82 N2,5 -716/18-39/82 N2,5</p>
<p>91-057 112-93 </p>  <p>-358/01-918/01</p>	<p>91-057 408-93 </p>  <p>-47/01</p>	<p>91-155 138-01</p>  <p>-771/01 (/04) -6/27 N2,5</p>	<p>91-155 247-93 </p>  <p>-780/01-6/03-980/02 N2,5</p>
<p>91-157 483-91</p>  <p>-771/01-151/10 N2,5</p>	<p>91-157 639-01</p>  <p>-771/01-6/07 N2,5</p>	<p>91-157 694-01</p> 	<p>-771/01-6/01 N2,5 -771/01 (/04) -6/21 N2,5</p>
<p>91-460 722-93 x 0,8</p>  <p>-44/42-915/05 N0,5</p>	<p>91-460 724-93 x 1,2</p>  <p>-44/42-915/05 N0,5</p>	<p>91-493 041-04  </p>  <p>-17/71-905/05</p>	<p>91-493 704-03 </p>  <p>-44/13 N0,5</p>
<p>91-494 181-93 </p>  <p>-39/81 N2,5 -195/02 N2,5</p>		<p>91-700 262-15 </p> <p>91-025 559-25 </p>  <p> 91-041 858-23</p> <p>-53/01</p>	

Unterklassen-Ubersicht/ Table of subclasses/ Table des sous-classes/ Tabla de subclasses

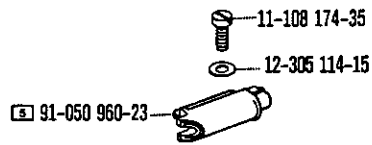

-17/31
-716/04-17/31 N2,5
-716/06-17/31 N2,5

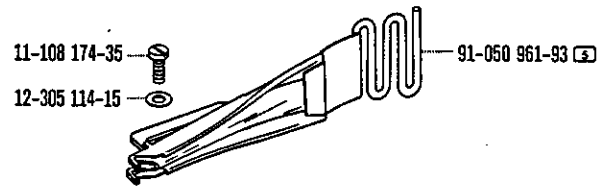

-39/31
-716/06-39/31 N2,5

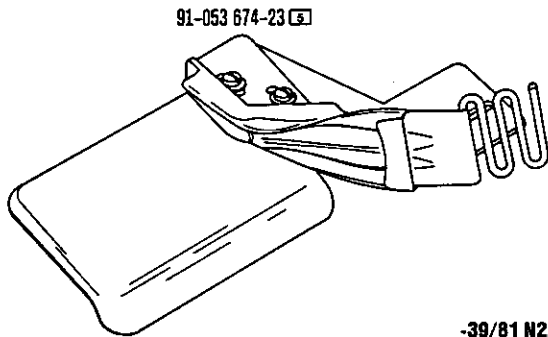

-39/81 N2,5

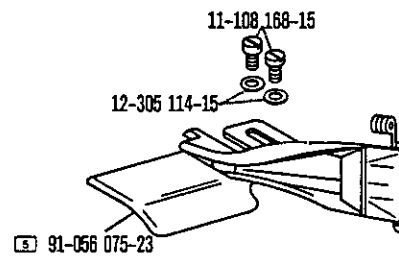

-716/08-39/82 N2,5
-716/18-39/82 N2,5

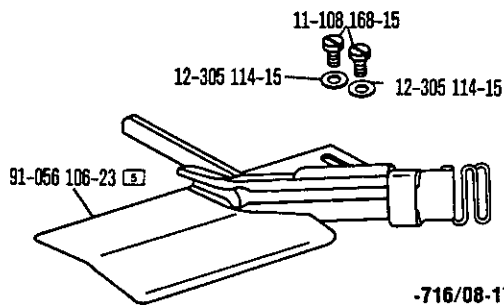

-716/08-17/82 N2,5
-716/18-17/82 N2,5

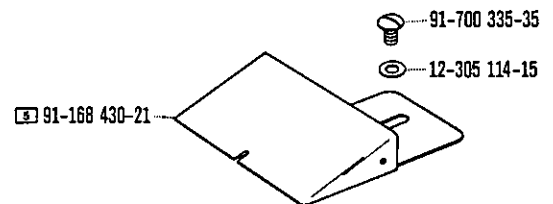

-358/01-918/01

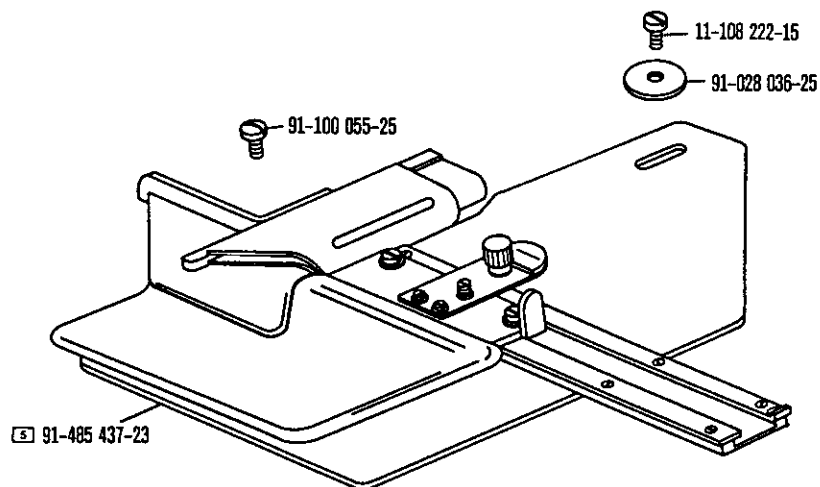

Unterklassen-Übersicht/Table of subclasses/Table des sous-classes/Tabla de subclasses

91-494 369-23 

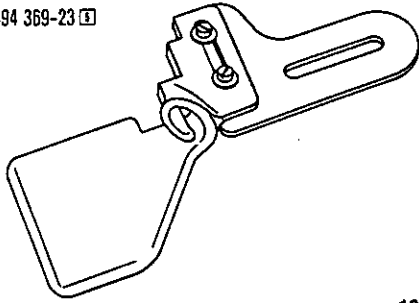

-195/02 N2,5

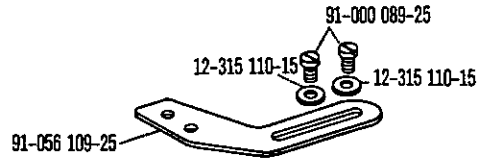

-716/08-17/82 N2,5
 -716/08-39/82 N2,5
 -716/18-17/82 N2,5
 -716/18-38/82 N2,5

91-056 116-90

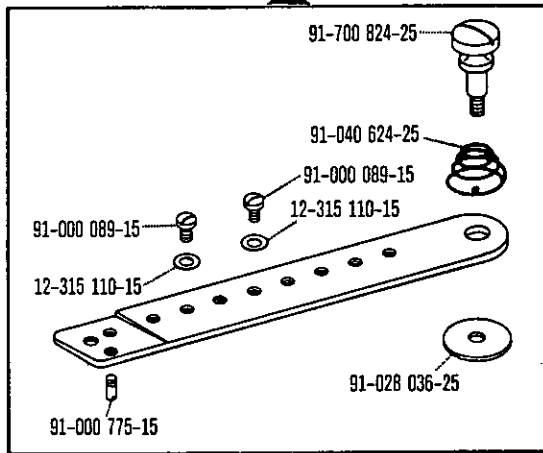

-39/81 N2,5
 -716/08-17/82 N2,5
 -716/08-39/82 N2,5
 -716/18-17/82 N2,5
 -716/18-39/82 N2,5

91-494 443-25

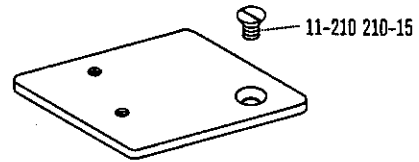

-17/71-905/05

91-753 936-90

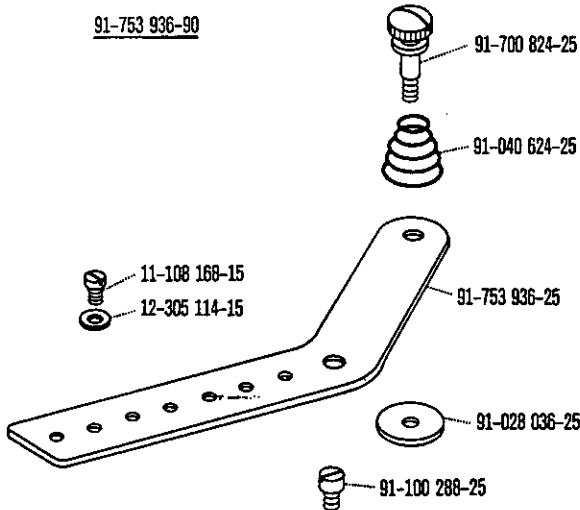

-195/02 N2,5

91-700 335-25

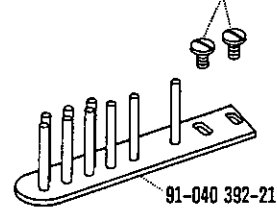



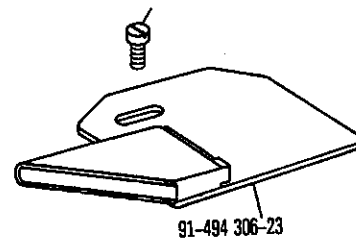

-17/31
 -716/04-17/31 N2,5
 -716/06-17/31 N2,5
 -716/06-39/31 N2,5

11-108 222-15

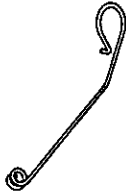

-17/71-905/05

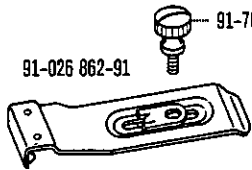
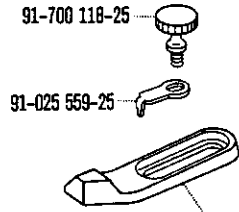
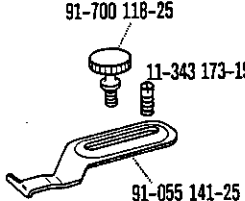
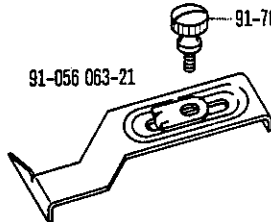
Unterklassen-Übersicht/Table of subclasses/Table des sous-classes/Tabla de subclasses

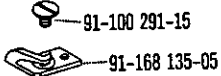
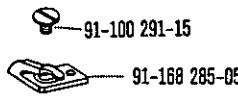
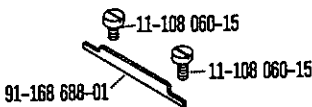
<p>91-168 034-15</p>  <p>-44/12 N0,5</p>	<p>91-168 878-15</p>  <p>91-100 270-15</p> <p>-44/42-915/05 N0,5</p>
 <p>91-026 862-91</p> <p>91-700 112-25</p> <p>-47/01</p>	 <p>91-700 118-25</p> <p>91-025 559-25</p> <p>91-040 998-25</p> <p>-55/01</p>
 <p>91-700 118-25</p> <p>11-343 173-15</p> <p>91-055 141-25</p> <p>-61/04 N2,5</p>	 <p>91-056 063-21</p> <p>91-700 112-25</p> <p>-47/11</p>
<p>91-167 973-05</p>  <p>-771/01 (/04) -6/21 N2,5</p> <p>-771/01 (/04) -6/27 N2,5</p>	 <p>91-100 291-15</p> <p>91-168 135-05</p> <p>-771/01-6/03 N2,5</p> <p>-771/01-6/07 N2,5</p> <p>-771/01-151/10 N2,5</p>
 <p>91-100 291-15</p> <p>91-168 285-05</p> <p>-771/02-6/01 N2,5</p>	 <p>11-108 060-15</p> <p>11-108 060-15</p> <p>91-168 688-01</p> <p>-771/01-6/03 N2,5</p> <p>-771/01-6/07 N2,5</p> <p>-771/01-151/10 N2,5</p> <p>-771/02-6/01 N2,5</p>

Unterklassen-Übersicht/ Table of subclasses/ Table des sous-classes/ Tabla de subclases

91-040 207-91

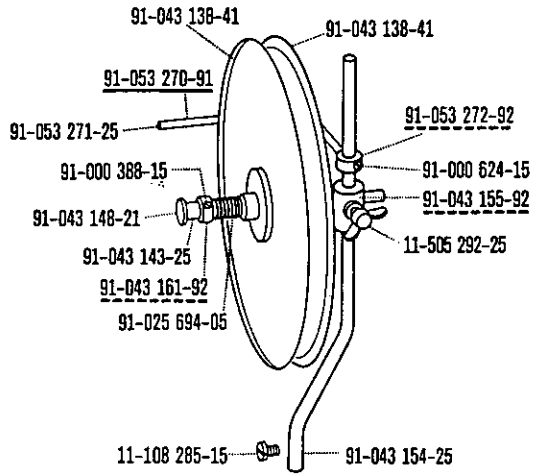

-61/04 N2,5

91-043 943-91

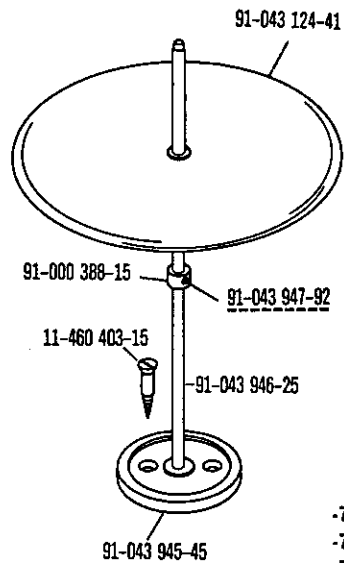

-716/08-17/82 N2,5
 -716/08-39/82 N2,5
 -716/18-17/82 N2,5
 -716/18-39/82 N2,5

91-046 211-91

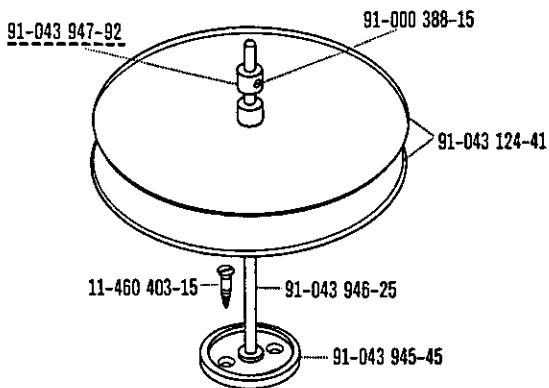

-17/71-905/05

91-156 075-91

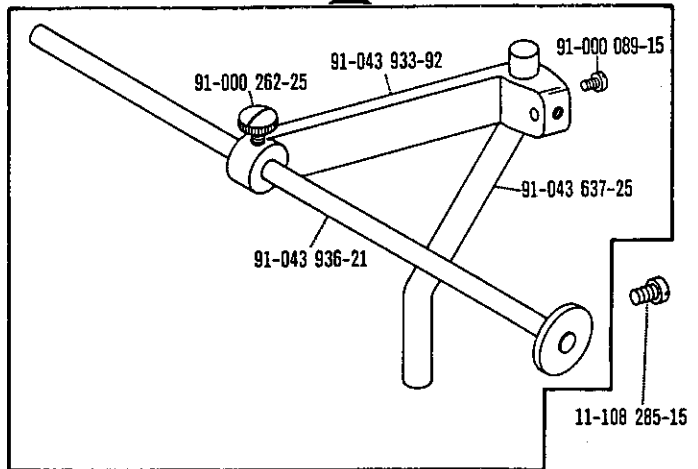

-44/42-915/05 N0,5

91-155 197-21

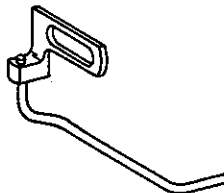

-780/01-6/03-980/02

PFAFF

G.M. PFAFF
Aktiengesellschaft

Postfach 3020
D-67653 Kaiserslautern

Königstr. 154
D-67655 Kaiserslautern

Telefon: (0631) 200-0
Telefax: (0631) 172 02
Telex: 45753 PFAFF D

Gedruckt in der BRD
Printed in Germany
Imprimé en R.F.A.
Impreso en la R.F.A.