

# PFAFF

## 335 H3

Unterklassen-Ausstattung

Subclass parts

Composition des sous-classes

Composición de las subclases

**Unterklassen-Ausstattung**  
**Equipement des sous-classes**

**Subclass organization**  
**Dotación de las subclases**

Unterklasse Subclass Sous-classe Subclase	Ausführung Model Version Tipo de máquina	Nadelstange Needle bar Barre à aiguille Barra de aguja	Stoffschieber <sup>4</sup> Feed dog Griffe Transportador inferior	Stichplatte <sup>4</sup> Needle plate Plaque à aiguille Placa de aguja	Stichplatten-Untersatz Needle plate base Support de plaque à aiguille Soporte de la placa de aguja	Nähfuß <sup>4</sup> Presser foot Pied presseur Pie prensateelas
-2/27	B; BN	91-712 488-92	91-059 229-04	91-158 206-04	91-048 303-35	91-049 534-04
-2/27-900/52	BN	91-712 488-92	91-059 229-04	91-158 206-04	91-014 048-25	91-049 534-04
-6/01	B; BN	91-710 650-92	91-046 008-04	91-046 009-04	91-014 636-35	91-043 989-04
-6/01-900/52	BN	91-710 650-92	91-046 008-04	91-046 009-04	91-014 047-25	91-043 989-04
-17/01	B; BN	91-710 650-92	91-046 497-04	91-046 498-05	91-014 636-35	91-040 432-04 <sup>12</sup>
-17/02	B	91-712 488-92	91-046 537-04	91-046 538-05	91-014 636-35	91-049 501-05
-17/03	B	91-710 650-92	91-047 174-04	91-048 491-05	91-014 636-35	91-040 432-04 <sup>12</sup>
-17/03	BN	91-710 650-92	91-047 174-04	91-493 375-05	91-014 636-35	91-040 432-04 <sup>12</sup>
-17/04	B	91-712 488-92	91-047 299-04	91-048 751-05	91-014 636-35	91-049 603-05
-17/05	B; BN	91-710 650-92	91-045 051-04	91-046 052-05	91-014 636-35	91-044 227-04 <sup>12</sup>
-17/06	B	91-710 650-92	91-047 145-04	91-048 378-05	91-014 636-35	91-049 584-04
-17/07	B	91-710 650-92	91-047 145-04	91-048 378-05	91-014 636-35	91-049 584-04
-39/21	B; BN	91-710 650-92	91-046 051-04	91-046 052-05	91-014 636-35	91-044 227-04 <sup>12</sup>
-39/23	B	91-710 650-92	91-047 183-04	91-048 545-01	91-014 715-35	91-049 835-05
-40/03	B	91-710 650-92	91-046 008-04	91-045 997-05	91-014 636-35	91-044 102-04 <sup>5</sup>
-40/07	B	91-710 650-92	91-046 008-04	91-045 997-05	91-014 636-35	91-044 102-04 <sup>5</sup>
-40/64	BN 2,5; B	91-710 650-92	91-059 232-04	91-158 209-04	91-158 218-35	91-049 786-04
-155/01	B; BN	91-710 650-92	91-046 497-04	91-046 498-05	91-014 636-35	91-040 432-04 <sup>12</sup>

<sup>4</sup> = Ausführung angeben  
 = Indicate model  
 = Préciser la version  
 = Indíquese el tipo de máquina

<sup>5</sup> = Nähmuster einsenden  
 = Submit sewing sample  
 = Joindre échantillons de couture  
 = Envíese muestra de costura

<sup>12</sup> = Absteppbreite angeben  
 = Indicate stitching margin  
 = Indiquer le relarge de couture  
 = Indíquese el margen de costura

**Unterklassen-Übersicht/ Table of subclasses/ Table des sous-classes/ Tabla de subclases**

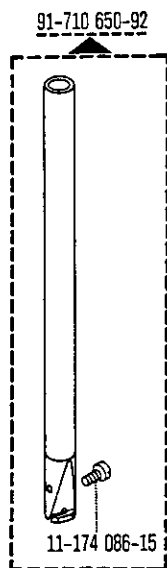

-6/01  
 -6/01-900/52  
 -17/01  
 -17/03  
 -17/05  
 -17/06  
 -17/07  
 -39/21  
 -39/23  
 -40/03  
 -40/07  
 -40/64

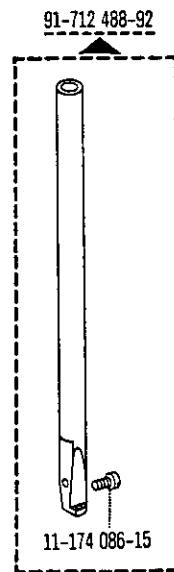

-2/27  
 -2/27-900/52  
 -17/02

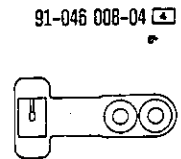

-6/01  
 -6/01-900/52  
 -40/03  
 -40/07

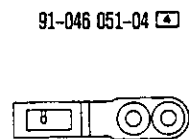





-17/05

Equipement des sous-classes  
Unterklassen-Ausstattung

Dotación de las subclases  
Subclass organization

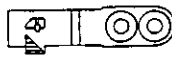
Subclass Sous-classe Subclase	Ausführung Model Version Tipo de máquina	Stoffschiebestufen Vibrating presser Pied enfraieur Transportador superior	Apparat Attachement Appareil Aparato	Abdeckplatte Cover plate Plaque de recouvrement Placa cubierta	Haltefinger Position finger Doigt d'arrêt Dedo de retén	Freiarmskappe Cylinder-bed cap Cache du bras inférieur Casquete del brazo cilíndrico	Lineal Edge guide Guide-bord Guía recta	Träger Bracket Support Soporte
'27	B; BN	91-049 042-93		91-040 476-35	91-048 304-35	91-014 704-35	91-044 043-91	91-040 477-25
'27-900/52	BN	91-049 042-93		91-040 476-35	91-014 844-35	91-014 891-35	91-044 043-35	91-040 477-25
'01	B; BN	91-043 847-93		91-014 643-31	91-014 637-34	91-014 638-35		
'01-900/52	BN	91-043 847-93		91-014 643-31	91-014 893-24 x 5,1	91-014 892-35		
7/01	B; BN	91-040 629-93 [17]	91-040 452-23	91-040 895-91	91-014 637-34	91-014 638-35		
7/02	B	91-049 001-93	91-040 452-23	91-040 895-91	91-014 637-34	91-014 638-35		
7/03	B	91-040 629-93 [17]	91-053 444-23	91-040 895-91	91-014 637-34	91-014 638-35		
7/03	BN	91-040 629-93 [17]	91-053 444-23	91-040 895-91	91-014 637-34	91-014 638-35		
7/04	B	91-049 001-93	91-050 886-13		91-014 637-34	91-014 638-35		
7/05	B; BN	91-042 819-93 [17]	91-040 244-23	91-040 895-91	91-014 637-34	91-014 638-35		
7/06	B	91-049 075-93	91-053 628-23	91-040 895-91	91-014 637-34	91-014 638-35		
7/07	B	91-049 075-93	91-053 628-23	91-040 895-91	91-014 637-34	91-014 638-35		
3/21	B; BN	91-042 819-93 [17]	91-040 415-23	91-040 895-91	91-014 637-34	91-014 638-35		
3/23	B	91-049 063-93	91-053 572-23	91-053 573-35	91-014 637-34	91-014 638-35		
3/03	B	91-044 101-93 [5]	91-044 015-23	91-040 476-35	91-014 637-34	91-014 639-35		91-040 477-25
3/07	B	91-044 101-93 [5]	91-490 515-23	91-040 476-35	91-014 637-34	91-014 639-35		91-040 477-25
3/64	BN 2.5, B	91-049 327-93	91-056 616-93	91-014 643-31	91-014 637-34	91-014 638-35		
55/01	B; BN	91-040 629-93 [17]	91-040 414-23	91-040 895-91	91-014 637-34	91-014 638-35		

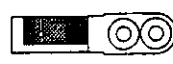
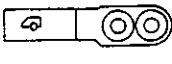
Unterklassen-Übersicht/Table of subclasses/Table des sous-classes/Tabla de subclases

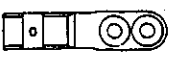
<p>91-046 497-04 [4]</p>  <p>-17/01 -155/01</p>	<p>91-046 537-04 [4]</p>  <p>-17/02</p>	<p>91-047 145-04 [4]</p>  <p>-17/06 -17/07</p>	<p>91-047 174-04 [4]</p>  <p>-17/03</p>
<p>91-047 183-04 [4]</p>  <p>-39/23</p>	<p>91-047 299-04 [4]</p>  <p>-17/04</p>	<p>91-059 229-04 [4]</p>  <p>-2/27 -2/27-900/52</p>	<p>91-059 232-04 [4]</p>  <p>-40/64 N2,5</p>

### Unterklassen-Ausstattung



### Subclass organization

### Equipement des sous-classes





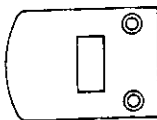
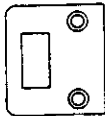
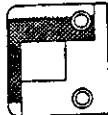
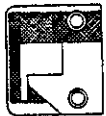
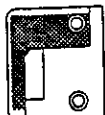
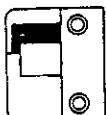

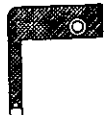



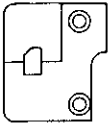
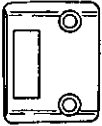

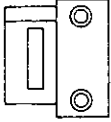
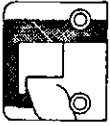
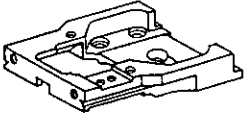
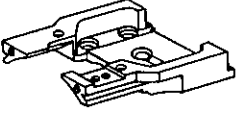
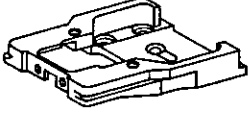
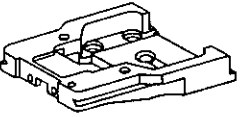
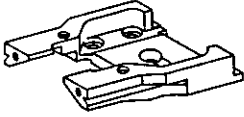
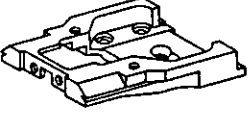



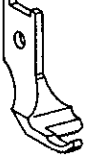











### Dotación de las subclases









Subclass Sous-classe Subclase	Ausführung Model Version Tipo de máquina	Halterwinkel Breckel Equerre de retenue Soporte angular	Bandleiter Tape disc Plaque d'rouleur Plato portacintas	Bandführung Tape guide Guide-tuban Guiacintas	Bandmacher Tape puller Distributeur de ruban Distribuidor de cinta	Messer Knife Couteau Cuchilla	Schub- und Schneideinrichtung Tape feeder and cutter Dispositif d'avance et de coupe Dispositivo de avance y de corte	Fingerschutz Finger guard Protege-doligs Salvededos
2/27	B, BN	91-025 559-25						91-055 203-91
2/27-900/52	BN	91-025 559-25						91-055 203-91
3/01	B, BN							91-055 203-91
3/01-900/52	BN							91-055 203-91
17/01	B, BN		91-043 943-91					91-055 203-91
17/02	B		91-043 943-91					91-055 203-91
17/03	B		91-043 943-91	91-053 445-93	91-053 450-25			91-055 203-91
17/03	BN		91-043 943-91	91-053 445-93	91-053 450-25			91-055 203-91
17/04	B		91-043 943-91			91-050 878-05	91-050 860-91	91-055 203-91
17/05	B, BN		91-043 943-91					91-055 203-91
17/06	B		91-043 943-91	91-053 354-24 [5]				91-055 203-91
17/07	B		91-043 943-91					91-055 203-91
39/21	B, BN		91-043 943-91					91-055 203-91
39/23	B		91-043 943-91					91-055 203-91
40/03	B							91-055 203-91
40/07	B							91-055 203-91
40/64	BN 2.5, B			91-042 036-91				91-055 203-91
155/01	B, BN		91-043 943-91					91-055 203-91

### Unterklassen-Übersicht/ Table of subclasses/ Table des sous-classes/ Tabla de subclases

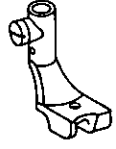
<p>91-045 997-05</p>  <p>-40/03 -40/07</p>	<p>91-046 009-04 [A]</p>  <p>-6/01 -6/01-900/52</p>	<p>91-046 052-05</p>  <p>-17/05 -39/21</p>	<p>91-046 498-05</p>  <p>-17/01 -155/01</p>
<p>91-046 538-05</p>  <p>-17/02</p>	<p>91-048 378-05</p>  <p>-17/06 -17/07</p>	<p>91-048 491-05</p>  <p>-17/03</p>	<p>91-048 545-01</p>  <p>-39/21</p>

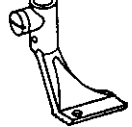
Unterklassen-Übersicht/Table of subclasses/Table des sous-classes/Tabla de subclasses

<p>91-048 751-05</p>  <p>-17/04</p>	<p>91-158 206-04</p>  <p>-2/27 -2/27-900/52</p>	<p>91-158 209-04 </p>  <p>-40/64 N2,5</p>	<p>91-493 375-05</p>  <p>-17/03</p>
<p>91-014 047-25</p>  <p>-6/01-900/52</p>	<p>91-014 048-25</p>  <p>-2/27-900/52</p>	<p>91-014 636-35</p> 	<p>-6/01 -17/06 -17/01 -17/07 -17/02 -39/21 -17/03 -40/03 -17/04 -40/07 -17/05 -155/01</p>
<p>91-014 715-35</p>  <p>-39/23</p>	<p>91-048 303-35</p>  <p>-2/27</p>	<p>91-158 218-35</p>  <p>-40/64 N2,5</p>	
<p>91-040 432-04  </p>  <p>-17/01 -17/03 -155/01</p>	<p>91-043 989-04 </p>  <p>-6/01 -6/01-900/52</p>	<p>91-044 102-04   </p>  <p>-40/03 -40/07</p>	<p>91-044 227-04  </p>  <p>-17/05 -39/21</p>
<p>91-049 501-05</p>  <p>-17/02</p>	<p>91-049 534-04 </p>  <p>-2/27 -2/27-900/52</p>	<p>91-049 584-04 </p>  <p>-17/06 -17/07</p>	<p>91-049 603-05</p>  <p>-17/04</p>
<p>91-049 786-04 </p> 	<p>91-049 835-05 </p> 		<p>91-040 629-93   </p>  <p>-17/01 -17/03</p>

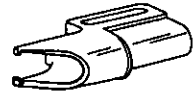
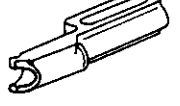
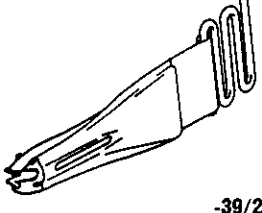
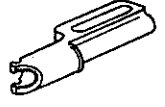
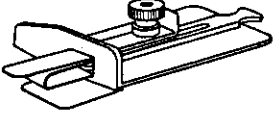
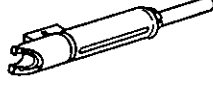
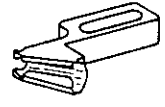
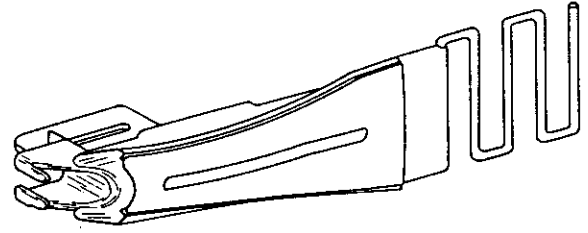
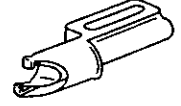
<p>91-042 819-93 </p> <p>-17/05 -39/21</p>	<p>91-043 847-93 </p> <p>-6/01 -6/01-900/52</p>	<p>91-044 101-93 </p> <p>-40/03 -40/07</p>	<p>91-049 001-93 </p> <p>-17/02 -17/04</p>
<p>91-049 042-93 </p> <p>-2/27 -2/27-900/52</p>	<p>91-049 063-93 </p> <p>-39/23</p>	<p>91-049 075-93 </p> <p>-17/06 -17/07</p>	<p>91-049 327-93 </p> <p>-40/64 N2.5</p>
<p></p>	<p>91-040 244-23 </p> <p>-17/05</p>	<p>91-040 414-23 </p> <p>-155/01</p>	<p>91-040 415-23 </p> <p>-39/21</p>
<p>91-040 452-23 </p> <p>-17/01 -17/02</p>	<p>91-044 015-23 </p> <p>-40/03</p>	<p>91-050 886-13 </p> <p>-17/04</p>	<p>91-053 444-23 </p> <p>-17/03</p>
<p>91-053 572-23 </p> <p>-39/23</p>			<p>91-053 628-23 </p> <p>-17/06 -17/07</p>

91-056 616-23 5

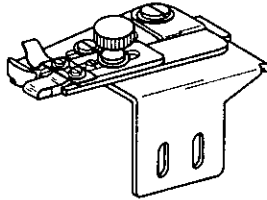

-40/64

91-490 515-93 5

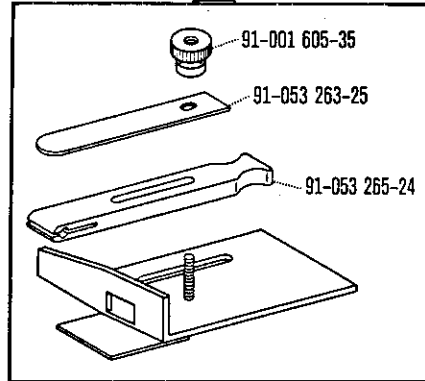

-40/07

91-014 643-31

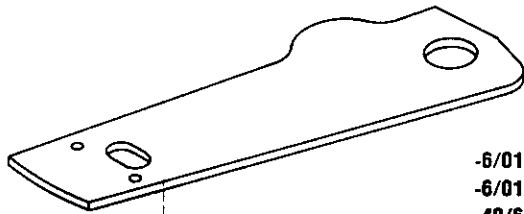

-6/01  
-6/01-900/52  
-40/64

91-040 476-35

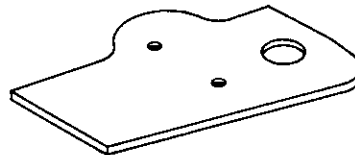

-2/27  
-2/27-900/52  
-40/03  
-40/07

91-040 895-91

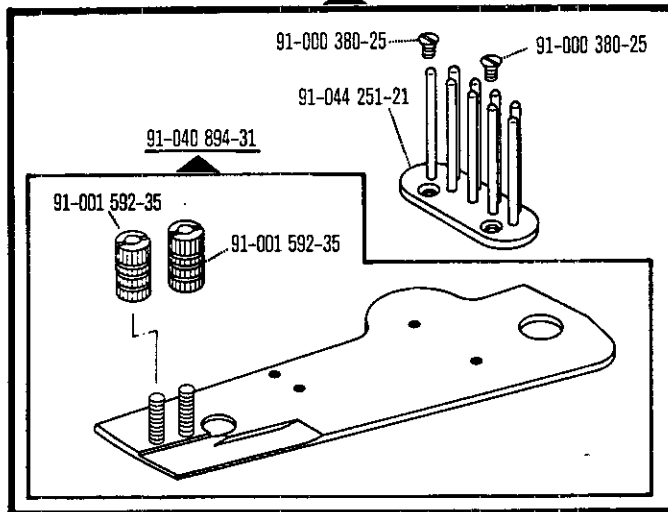





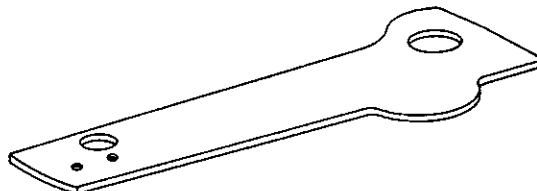

-17/01  
-17/02  
-17/03  
-17/05  
-17/06  
-17/07  
-39/21  
-155/01

91-053 573-35

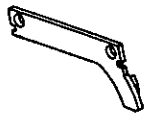
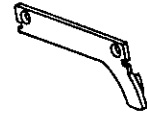

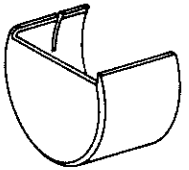
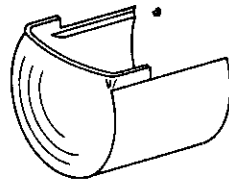
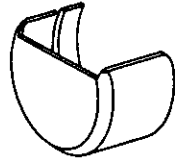
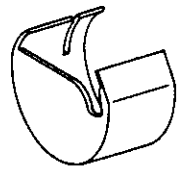
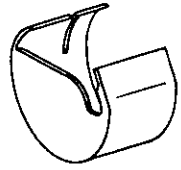
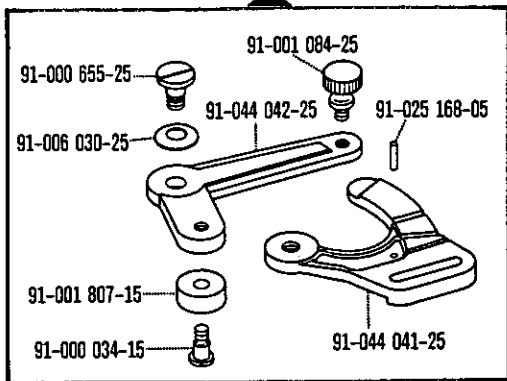
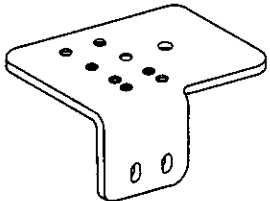
-39/23

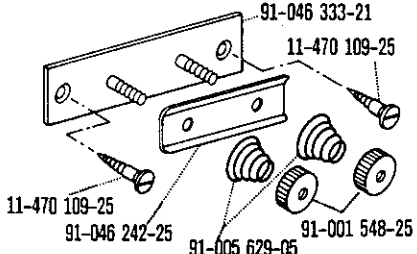
**Unterklassen-Übersicht/ Table of subclasses/ Table des sous-classes/ Tabla de subclasses**

<p>91-014 637-34</p>  <p>-6/01 -17/07 -17/01 -39/21 -17/02 -39/23 -17/03 -40/03 -17/04 -40/07 -17/05 -40/64 -17/06 -155/01</p>	<p>91-014 844-35</p>  <p>-2/27-900/52</p>	<p>91-014 893-35</p>  <p>-6/01-900/52</p>	<p>91-048 304-35</p>  <p>-2/27</p>
<p>91-014 638-35</p>  <p>-6/01 -17/06 -17/01 -17/07 -17/02 -39/21 -17/03 -39/23 -17/04 -40/64 -17/05 -155/01</p>	<p>91-014 639-35</p>  <p>-40/03 -40/07</p>	<p>91-014 704-35</p>  <p>-2/27</p>	
<p>91-014 891-35</p>  <p>-2/27-900/52</p>	<p>91-014 892-35</p>  <p>-6/01-900/52</p>	<p>91-044 043-91</p>  <p>91-000 655-25 91-006 030-25 91-001 807-15 91-000 034-15 91-001 084-25 91-044 042-25 91-025 168-05 91-044 041-25</p>	
<p>91-040 477-25</p>  <p>-2/27 -2/27-900/52</p> <p>-40/03 -40/07</p>	<p>91-000 262-25</p>  <p>91-025 559-25</p> <p>-2/27 -2/27-900/52</p>	<p>-2/27 -2/27-900/52</p>	
<p>91-042 036-91</p>  <p>91-046 333-21 11-470 109-25 11-470 109-25 91-046 242-25 91-005 629-05 91-001 548-25</p>		<p>91-053 354-24</p> 	



91-053 445-93

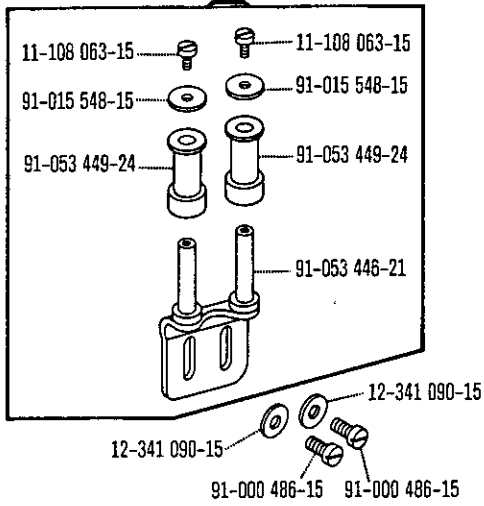

-17/03

91-053 450-25



-17/03

91-050 878-05



-17/04

91-043 943-91

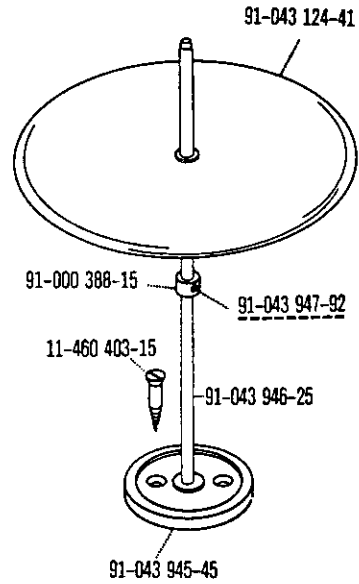

-17/01  
-17/02  
-17/03  
-17/04  
-17/05  
-17/06  
-17/07  
-39/21  
-39/23  
-155/01

91-055 203-91

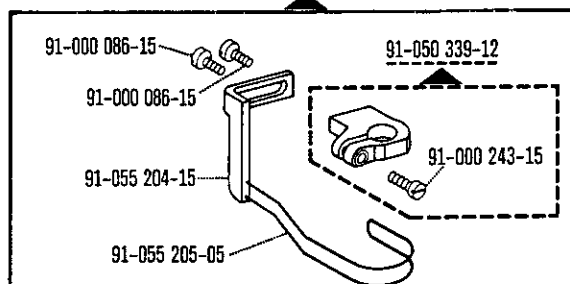

-17/05  
-17/06  
-2/27  
-2/27-900/52  
-17/07  
-6/01  
-39/21  
-6/01-900/52  
-39/23  
-17/01  
-40/03  
-17/02  
-40/07  
-17/03  
-40/64  
-17/04  
-155/01

91-050 860-91

