

PFAFF

1421 E1







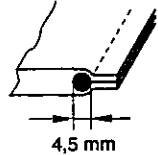

Unterklassen-Ausstattung

Subclass parts

Composition des sous-classes







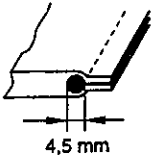

Composición de las subclases

Table of subclasses
 Table des sous-classes
 Tabla de subclases PFAFF 1421 E1

Unterklasse Subclass Sous-classe Subclase	-755/03-900/61	-755/03-900/61	-755/03-40/18-900/61
Arbeitsgang Operation Opération Operación	Zum Herstellen von Zier- und Befestigungsnähten. Schiebradtransport und angetriebener Rollfuß. For sewing fancy seams and assembly seams. Wheel feed and driven roller presser. Pour exécuter les coutures d'ornementation et de fixation. Avec entraînement par rove et pied à roulette entraîné. Para ejecutar costuras de adorno y fijación. Transportador inferior de rueda y pie rodante accionado.	Zum Herstellen von Zier- und Befestigungsnähten. Schiebradtransport und angetriebener Rollfuß. For sewing fancy seams and assembly seams. Wheel feed and driven roller presser. Pour exécuter les coutures d'ornementation et de fixation. Avec entraînement par rove et pied à roulette entraîné. Para ejecutar costuras de adorno y fijación. Transportador inferior de rueda y pie rodante accionado.	
Ausführung Model Version Tipo de máquina	BN5	B/CN5	BN5
Schneidabstand in mm Trimming margin in mm Distance de coupe en mm Margen de corte en mm			
Nadelstange Needle bar Barre à aiguille Barra de aguja	91-164 412-91	91-164 412-91	91-164 412-91
Rollfuß  Roller presser Pied à roulette Pie rodante	91-164 697-93  	91-164 697-93  	91-164 924-91  
Stichplatte  Needle plate Plaque à aiguille Placa de aguja	91-150 215-03	91-150 215-03	91-150 659-03
Schiebrad Feed wheel Roue d'entraînement Rueda transportadora	91-164 399-92	91-164 399-92	91-164 918-92
Lineal Edge guide Guide-droit Guiá recta	09-009 851-98	09-009 851-98	09-009 851-98

Unterklassen-Übersicht
Table of subclasses
Table des sous-classes
Tabla de subclases

PFAFF 1421 E1

Unterklasse Subclass Sous-classe Subclase	-755/03-40/18-900/61	-755/03-40/19-900/61	-755/03-40/19-900/61
Arbeitsgang Operation Opération Operación	 <p>4,5 mm</p>	<p>Wie -40/18, jedoch Kederdurchmesser 5,0 mm; Nahtabstand zum Keder geringfügig größer. Identical to -40/18, welt diameter however 5.0 mm; distance of seam to the welt slightly greater. Comme -40/18, mais diam. de jonc 5,0 mm; distance de couture du jonc légèrement supérieure. Como la -40/18, pero diámetro del vivo de 5,0 mm; distancia de la costura al vivo ligeramente mayor.</p>	<p>Wie -40/18, jedoch Kederdurchmesser 5,0 mm; Nahtabstand zum Keder geringfügig größer. Identical to -40/18, welt diameter however 5.0 mm; distance of seam to the welt slightly greater. Comme -40/18, mais diam. de jonc 5,0 mm; distance de couture du jonc légèrement supérieure. Como la -40/18, pero diámetro del vivo de 5,0 mm; distancia de la costura al vivo ligeramente mayor.</p>
Ausführung Model Version Tipo de máquina	B/CN5	BN5	B/CN5
Schneidabstand in mm Trimming margin in mm Distance de coupe en mm Margen de corte en mm			
Nadelstange Needle bar Barre à aiguille Barra de aguja	91-164 412-91	91-164 412-91	91-164 412-91
Rollfuß  Roller presser Pied à roulette Pie rodante	91-164 924-91  	91-164 938-91  	91-164 938-91  
Stichplatte  Needle plate Plaque à aiguille Placa de aguja	91-150 659-03	91-150 661-03	91-150 661-03
Schiebrad Feed wheel Roue d'entraînement Rueda transportadora	91-164 918-92	91-164 935-91	91-164 935-91
Lineal Edge guide Guide-droit Guía recta	09-009 851-98	09-009 851-98	09-009 851-98

siehe Erläuterungen Register 0
see explanations in section 0
voir légende registre 0
ver explicaciones del registro 0

<p>91-164 412-91</p> <p>91-164 413-01</p> <p>11-330 958-15</p> <p>11-108 093-15</p> <p>91-164 416-05</p> <p>-755/03-900/61 -755/03-40/18-900/61 -755/03-40/19-900/61</p>	<p>91-164 303-93 <input type="checkbox"/> A <input type="checkbox"/> 28 <input type="checkbox"/> 70/1 <input type="checkbox"/> 90/70</p> <p>-755/03-900/61</p>	<p>91-164 502-93 <input type="checkbox"/> A <input type="checkbox"/> 28 <input type="checkbox"/> 70/8 <input type="checkbox"/> 90/70</p> <p>-755/03-900/61</p>	
	<p>91-164 697-93 <input type="checkbox"/> A <input type="checkbox"/> 70/9 <input type="checkbox"/> 90/71</p> <p>-755/03-900/61</p>	<p>91-164 907-91 <input type="checkbox"/> A <input type="checkbox"/> 28 <input type="checkbox"/> 70/10 <input type="checkbox"/> 90/71</p> <p>-755/03-900/61</p>	
<p>91-164 924-91 <input type="checkbox"/> A <input type="checkbox"/> 70/13 <input type="checkbox"/> 90/71</p> <p>-755/03-40/18-900/61</p>	<p>91-164 938-91 <input type="checkbox"/> A <input type="checkbox"/> 70/18 <input type="checkbox"/> 90/71</p> <p>-755/03-40/19-900/61</p>	<p>91-164 939-91 <input type="checkbox"/> A <input type="checkbox"/> 28 <input type="checkbox"/> 70/13 <input type="checkbox"/> 90/71</p> <p>-755/03-900/61</p>	<p>91-164 941-91 <input type="checkbox"/> A <input type="checkbox"/> 28 <input type="checkbox"/> 70/14 <input type="checkbox"/> 90/70</p> <p>-755/03-900/61</p>
<p>91-150 215-03 <input type="checkbox"/> A <input type="checkbox"/> B <input type="checkbox"/> B/C</p> <p>-755/03-900/61</p>		<p>91-150 659-03 <input type="checkbox"/> A <input type="checkbox"/> B <input type="checkbox"/> B/C</p> <p>-755/03-40/18-900/61</p>	

91-150 661-03 A B B/C

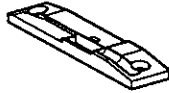

-755/03-40/19-900/61

91-164 399-92 B B/C

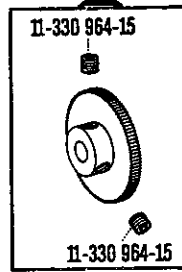

-755/03-900/61

91-164 918-92 B B/C

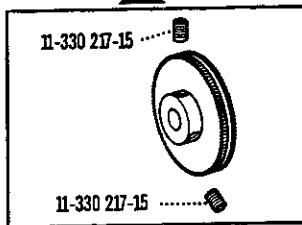

-755/03-40/18-900/61

91-164 935-91 B B/C

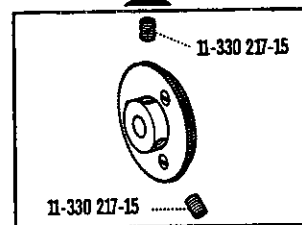

-755/03-40/19-900/61

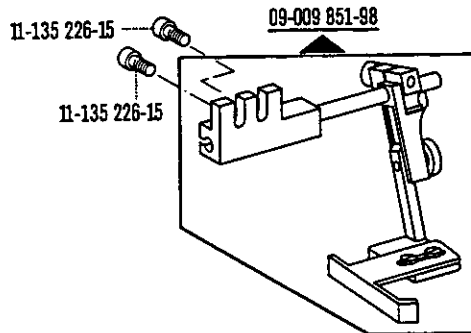

-755/03-900/61
 -755/03-40/18-900/61
 -755/03-40/19-900/61

siehe Erläuterungen Register 0
 see explanations in section 0
 voir légende registre 0
 ver explicaciones del registro 0

PFAFF